

From : Director, SUDA

To
The Chairperson, Board of Administrator
.....Municipality

Sub. : Clean Ganga - immediate action required on the findings of Swachh Survekshan-2020 during the assessment of Ganga Towns - regarding.

Ref. : No.Q-16025/38/2018-CPHEEO Dt.-21.08.2020

Sir/Madam,

This is to inform you that we have received a letter from Ministry of Housing and Urban Affairs, Government of India on the subject matter cited above along with a Study Report based on survey conducted by GoI (copy enclosed) during Swachh Survekshan-2020.

According to their above assessment a large number of open dumps and GVPs have been found along the Ganga Ghats in ULBs mentioned in the Annexure enclosed.

You are therefore requested to kindly take necessary measures to identify & remove GVPs and open dumps near Ganga Ghats / along banks of River Ganga within your Municipal boundary in order to Clean Ganga River.

Swachh Survekshan – 2020, Assessment Report of Ganga Towns received from Ministry of Housing and Urban Affairs, Government of India is also attached herewith for your ready reference.

This may kindly be treated as urgent and please also send ^{an action taken} ~~a~~ compliance report to this office at an early date.

Enclo. : As stated

Yours faithfully,

Director, SUDA

From : Director, SUDA

To
The Chairman / Chairperson, Board of Administrator

.....**Municipal Corporation/Municipality**

Sub. : Clean Ganga - immediate action required on the findings of Swachh Survekshan-2020 during the assessment of Ganga Towns - regarding.

Ref. : No.Q-16025/38/2018-CPHEEO Dt.-21.08.2020

Sir/Madam,

This is to inform you that we have received a letter from Ministry of Housing and Urban Affairs, Government of India on the subject matter cited above along with a Study Report based on survey conducted by Gol (copy enclosed) during Swachh Survekshan-2020.

According to their above assessment a large number of open dumps and GVPs have been found along the Ganga Ghats in ULBs mentioned in the Annexure enclosed.

You are therefore requested to kindly take necessary measures to identify & remove GVPs and open dumps near Ganga Ghats / along banks of River Ganga within your Municipal boundary in order to Clean Ganga River.

Swachh Survekshan – 2020, Assessment Report of Ganga Towns received from Ministry of Housing and Urban Affairs, Government of India is also attached herewith for your ready reference.

This may kindly be treated as most urgent and please also send an action taken report to this office at an early date.

Engineering team of SUDA will visit at those locations thereafter with prior intimation to your office.

Enclo. : As stated

Yours faithfully,

Director, SUDA

URGENT ACTION
By e-mail only

No.Q-16025/38/2018-CPHEEO
Government of India
Ministry of Housing and Urban Affairs
(CPHEEO)

New Delhi, 21st August, 2020

OFFICE MEMORANDUM

Subject: Clean Ganga - Immediate action required on the findings of Swachh Survekshan-2020 during the assessment of Ganga Towns – regarding.

The undersigned is directed to refer to the **Swachh Survekshan 2020 – Assessment of 97 Ganga towns Report** released by the Ministry on 21/08/2020 during Award Ceremony of SS-2020 and to convey that a large number of open dumps and GVPs have been found along the Ganga Ghats in ULBs mentioned in the Annexure enclosed. It is requested to urgently direct the officials concerned to remove GVPs and open dumps in the ULBs concerned in your respective States as immediate action for Clean Ganga and report back to this Ministry. Swachh Survekshan 2020 – Assessment of 97 Ganga towns Report is available on the website <http://swachhbharaturban.gov.in/>. It is also attached.

(The assessment did not cover Barauni (Bihar), Pandit Deen Dayal Upadhyaya (Uttar Pradesh), Gayeshpur (West Bengal), Badrinath & Gangotri Dham (Uttarakhand))

Ankit Jain
21/08/2020

(Ankit Jain)

Asst. Adviser (PHE)

Tel: 011-23063581

ankit.j@nic.in

To

- 1) Mission Directors, SBM – Urban (Uttarakhand, Uttar Pradesh, Bihar, Jharkhand and West Bengal);
- 2) Project Directors – Clean Ganga SPMG (Uttarakhand, Uttar Pradesh, Bihar, Jharkhand and West Bengal);

Copy for information to:

National Mission Clean Ganga:

A. Director General, National Mission for Clean Ganga

Internal:

1. Advisor (PHEE)
2. Director (SBM & PHE)
3. JA (VKC) and JA (JBR)

West Bengal

Name of Town	No. of Ghats	Solid Waste spotted on river	GVP on or around Ghats	Open dump site around river
Haldia	2	0	0	0
Barrackpore	4	3	2	8
Maheshtala	1	3	2	0
Katwa	13	6	0	1
Halishahar	6	0	5	11
Nabadwip	3	2	1	3
Naihati	9	1	9	17
Bally	7	0	0	3
Howrah	5	0	2	1
Baidyabati	10	0	0	1
Kolkata	8	2	7	3
Titagarh	5	3	0	2
Khardah	10	7	1	3
Konnagar	5	1	4	8
Uluberia	5	0	0	4
Chandannagar	6	0	0	1
Uttarpara	5	0	3	4
Baranagar	8	10	3	11
Champdani	5	4	1	4
Bhadreshwar	2	0	0	0
Budge Budge	6	6	10	10
Panihati	32	14	9	30
Jiaganj- Azimganj	7	2	5	2
Kamarhati	7	1	0	5
Bhatpara	6	5	1	3
Hugli- Chinsurah	6	4	0	4
Kanchrapara	1	0	2	2
Diamond Harbour	3	0	6	4
Kalyani	4	1	4	2
Bansberia	6	4	0	2
Murshidabad	5	0	4	3
Rishra	6	6	0	4
Berhampore	13	12	10	7
Garulia	18	3	3	20
Jangipur	4	0	4	3
Serampore	9	6	1	4
Chakdah	1	2	2	2
Santipur	2	4	4	4
Dhulian	20	1	20	17
Total	275	113	125	213



आत्मनिर्भर भारत



Ministry of Housing and Urban Affairs
Government of India



एक कदम स्वच्छता की ओर

**SWACHH
SURVEKSHAN
2020**

**Assessment of
97 Ganga Towns**



हरदीप एस पुरी
HARDEEP S PURI



सत्यमेव जयते



आवासन और शहरी कार्य राज्य मंत्री (स्वतंत्र प्रभार)
नागर विमानन राज्य मंत्री (स्वतंत्र प्रभार)
वाणिज्य एवं उद्योग राज्य मंत्री
भारत सरकार

Minister of State (I/C), Housing & Urban Affairs
Minister of State (I/C), Civil Aviation
Minister of State, Commerce & Industry
Government of India

Message

"Sanitation is more important than political independence" – Mahatma Gandhi

These words of the Father of the Nation truly reflect the importance that the Mahatma laid on cleanliness and sanitation. In order to give shape to this dream of a Clean India, the Hon'ble Prime Minister, Shri Narendra Modi launched the 'Swachh Bharat Mission' on 2 October 2014. To inculcate a spirit of healthy competition among towns and cities around Swachhata, the Swachh Survekshan – Urban was launched in 2016.

As part of a multi-pronged strategy developed to meet the objectives of 'Swachh Survekshan - the assessment of Ganga Towns was initiated in 2019 with an objective to evaluate their levels of cleanliness on a set of predefined indicators. Improvement in the overall cleanliness of nullahs and increased accessibility of municipal solid waste (MSW) plants across the Ganga towns have acted as positive catalysts in improving standards of cleanliness.

I am happy to release this survey report today wherein we have shared the details of 97 Ganga towns that were assessed and ranked on key cleanliness and sanitation parameters. This assessment of Ganga towns is an important step in our journey towards a Swachh and Swasth India.

(Hardeep S Puri)



23 July 2020
New Delhi

Executive Summary

Assessment of 97 Ganga Towns was undertaken by Ipsos Research Private Limited, under Swachh Survekshan 2020. The evaluation was executed with constant support and guidance of Ministry of Housing and Urban Affairs (MoHUA) to measure the cleanliness in and around ghats. The survey was executed using direct observation within a span of 15 days (16th - 31st January 2020). The study was executed in the five states, from where Ganga river flows, coverage of the project is depicted below:

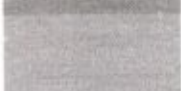

State-wise Number of Ganga Towns

	Uttarakhand – 16
	Uttar Pradesh – 21
	Bihar – 18
	Jharkhand – 2
	West Bengal – 40

The parameters covered in this study are as follows:

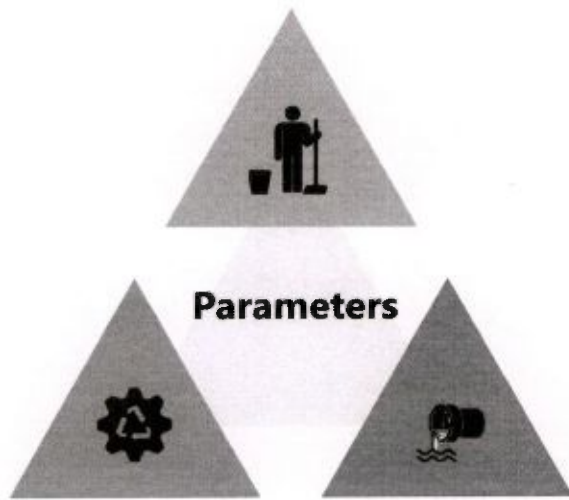

01 Overall Cleanliness

- ❖ No open Dumpsites present near the Ghat area.
- ❖ No Garbage Vulnerable Points (GVP) present near the Ghat area.
- ❖ No Solid waste found floating on the river Ganga.

02 Solid Waste Management (SWM) services:

- ❖ Placement and accessibility of Anti-littering messages / hoarding for citizens.
- ❖ Adequate twin-litterbins placed in every 50 m of Ghats.
- ❖ Sweeping and Cleaning arrangements in place for Ghats.
- ❖ Availability trash cleaner to trap the solid waste floating on river surface.

03 Nullahs and Screens:

- ❖ Number of external nullahs getting discharged directly into river Ganga.
- ❖ Nullahs having functional screens installed.
- ❖ Screens of nullahs are not choked.

04 Availability of MSW plant in the town

The survey was conducted in January 2020, covering 863 Ganga Ghats across 97 towns. A team of 30 assessors were trained and employed for conducting the assessment. These assessors were further monitored / lead by Executive Officers. Project coverage is depicted below:

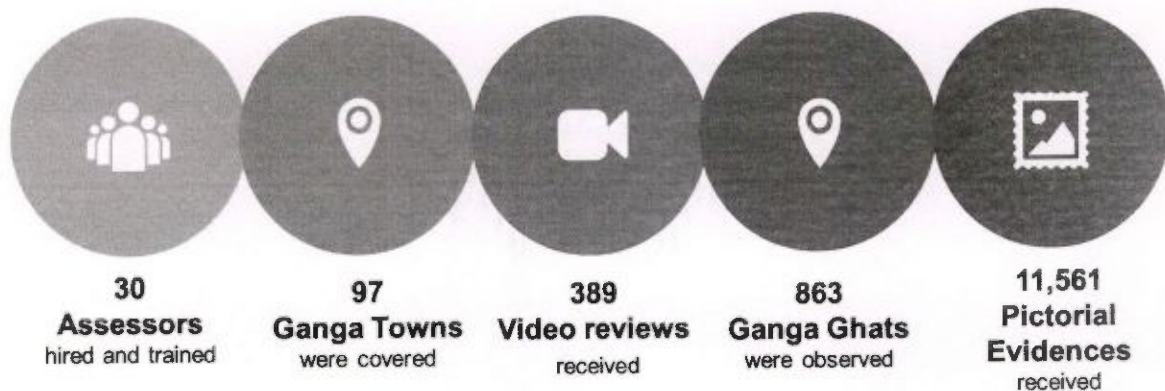

The key findings of the survey are briefed below:



52 towns had anti-littering messages placed across Ghats.



Across 46 towns, no solid waste was found floating on river surface.



Out of 97 Ganga towns, no GVPs were observed in 34 towns.



No open dumpsites were spotted around vicinity of Ghats in 29 towns.



Among 97 towns, sweeping and cleaning arrangements were available in 62 towns.



19 towns had functional municipal solid waste (MSW) plants.



In 31 towns, it was observed that no nullah were being discharged into the river.



Twin-Litterbins were placed in every 50 meters of Ghats across 58 towns.



Availability of Trash Cleaners was observed in 13 towns.

Abovementioned data has been detailed in subsequent chapters of the report.

Disclaimer: During on-ground assessment it was identified that in Barauni (Bihar), Pandit Deen Dayal Upadhyaya (Uttar Pradesh) and Gayeshpur (West Bengal) Ganga Ghats were not found; in Badrinath & Gangotri Dham of Uttarakhand were closed due to extreme weather conditions. Therefore, 92 Ganga Towns were assessed.

Chapter 7: State-wise Findings (West Bengal)

7.1: State-wise findings:

Out of 97 assessed towns, 39 of them were located in West Bengal. Overall 275 Ghats were observed in West Bengal during the survey. Following are major findings:



275 Ghats Covered
Across Ganga Towns of West Bengal, 275 Ghats were covered during the survey.



Anti-littering messages were placed in 22 towns
The anti-littering messages were placed across Ghats of 22 out of 40 towns.



No Trash Cleaners were available in towns
Trash cleaner was not available in any town.



Twin-Litter Bin was placed across Ghats of 27 towns
Twin-litter bin was placed across Ghats of 27 out of 40 towns.



Sweeping and Cleaning Arrangements were present in 26 towns
Sweeping and cleaning arrangements were available across Ghats of 26 towns.



MSW plants were not available in towns.
Across West Bengal, MSW plant was not available in any town.

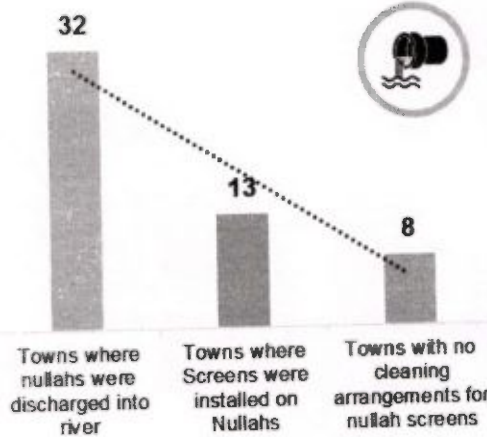

Nullahs were being discharged directly into river in 32 towns.

Nullahs were not being discharged directly into river in Haldia, Maheshtala, Nabadwip, Kanchrapara, Murshidabad, Chakdah and Santipur.

Screens were installed on nullahs of 13 towns.

Choked / no screen on nullah was observed 8 towns namely: Uluberia, Uttarpara, Baranagar, Champdani, Kamarhati, Hugli-Chinsurah, Diamond Harbour and Jangipur.

Status of Nullahs and Screens



রাজ্য নগর উন্নয়ন সংস্থা



STATE URBAN DEVELOPMENT AGENCY

“ইলগাস ভবন”, এইচ-সি ব্লক, সেক্টর-৩, বিধাননগর, কলকাতা-৭০০ ১০৬, পশ্চিমবঙ্গ
“ILGUS BHAVAN”, H-C Block, Sector - III, Bidhannagar, Kolkata - 700 106, West Bengal

ক্রমিক নং SUDA - 229/2018/1933(39)

তারিখ 18.09.2020

From : Director, SUDA

To 1. The Chairman/Chairperson, Municipality/NAA
2. The Chairperson, Board of Administrator, Municipality/NAA
3. The Municipal Commissioner, Municipal Corporation
4. The Administrator, Municipality

Sub. : Clean Ganga - immediate action required on the findings of Swachh Survekshan-2020 during the assessment of Ganga Towns - regarding.

Ref. : No.Q-16025/38/2018-CPHEEO Dt.-21.08.2020

Sir/Madam,

This is to inform you that we have received a letter from Ministry of Housing and Urban Affairs, Government of India on the subject matter cited above along with a Study Report based on survey conducted by Gol (copy enclosed) during Swachh Survekshan-2020.

According to their above assessment a large number of open dumps and GVPs have been found along the Ganga Ghats in ULBs mentioned in the Annexure enclosed.

You are therefore requested to kindly take necessary measures to identify & remove GVPs and open dumps near Ganga Ghats / along banks of River Ganga within your Municipal boundary in order to Clean Ganga River.

Swachh Survekshan - 2020, Assessment Report of Ganga Towns received from Ministry of Housing and Urban Affairs, Government of India is also attached herewith for your ready reference.

This may kindly be treated as most urgent and please also send an action taken report to this office at an early date. It may be kept in mind that Hon'ble NGT may take serious cognizance if the ULBs are found defaulter and indifferent in this regard.

After submission of Action Taken Report, team led by Engineers of SUDA will inspect the sites and report.

Enclo. : As stated

Yours faithfully,

Memo No. SUDA - 229/2018/1933(39)/1(1)

Director, SUDA

Date. 18.09.20

Copy forwarded for kind information and necessary action to :-

1) Sri Tapas Kumar Gupta, Chief Engineer (SWM), West Bengal Pollution Control Board

Director, SUDA

দূরভাষ : ২৩৫৮ ৬৪০৩ / ৫৭৬৭, ফ্যাক্স : ২৩৫৮ ৫৮০০

Tel : 2358 6403/5767, Fax : 2358 5800, E-mail : wbsudadir@gmail.com

Account Section : 2358 6408

রাজ্য নগর উন্নয়ন সংস্থা

STATE URBAN DEVELOPMENT AGENCY

“ইলগাস ভবন”, এইচ-সি ব্লক, সেক্টর-৩, বিধাননগর, কলকাতা-৭০০ ১০৬, পশ্চিমবঙ্গ
 “ILGUS BHAVAN”, H-C Block, Sector - III, Bidhannagar, Kolkata - 700 106, West Bengal

ক্রমিক নং

তারিখ

From : Director, SUDA

To

1. The Chairman/Chairperson, Municipality/NAA
2. The Chairperson, Board of Administrator, Municipality/NAA
3. The Municipal Commissioner, Municipal Corporation
4. The Administrator, Municipality

Sub. : Clean Ganga - immediate action required on the findings of Swachh Survekshan-2020 during the assessment of Ganga Towns - regarding.

Ref. : No.Q-16025/38/2018-CPHEEO Dt.-21.08.2020

Sir/Madam,

This is to inform you that we have received a letter from Ministry of Housing and Urban Affairs, Government of India on the subject matter cited above along with a Study Report based on survey conducted by Gol (copy enclosed) during Swachh Survekshan-2020.

According to their above assessment a large number of open dumps and GVPs have been found along the Ganga Ghats in ULBs mentioned in the Annexure enclosed.

You are therefore requested to kindly take necessary measures to identify & remove GVPs and open dumps near Ganga Ghats / along banks of River Ganga within your Municipal boundary in order to Clean Ganga River.

Swachh Survekshan – 2020, Assessment Report of Ganga Towns received from Ministry of Housing and Urban Affairs, Government of India is also attached herewith for your ready reference.

This may kindly be treated as most urgent and please also send an action taken report to this office at an early date. *It may be kept in mind that Hon'ble NHT may take SERIOUS COGNIZANCE*
 Engineering team of SUDA will visit at those locations thereafter, with prior intimation to your office.

Encl. : As stated

Yours faithfully,

Director, SUDA

↓
 After submission
 of ATR, Engineer team
 led by Engineers of SUDA
 will inspect the sites
 and report

←
 if the ULBs are found defaulters
 and indifferent in this regard.

দূরভাষ : ২৩৫৮ ৬৪০৩ / ৫৭৬৭, ফ্যাক্স : ২৩৫৮ ৫৮০০

Tel : 2358 6403/5767, Fax : 2358 5800, E-mail : wbsudadir@gmail.com

Account Section : 2358 6408

From : Director, SUDA

To 1. The Chairman/Chairperson, Municipality/NAA
2. The Chairperson, Board of Administrator, Municipality/NAA
3. The Municipal Commissioner, Municipal Corporation
4. The Administrator, Municipality

Sub. : Clean Ganga - immediate action required on the findings of Swachh Survekshan-2020 during the assessment of Ganga Towns - regarding.

Ref. : No.Q-16025/38/2018-CPHEEO Dt.-21.08.2020

Sir/Madam,

This is to inform you that we have received a letter from Ministry of Housing and Urban Affairs, Government of India on the subject matter cited above along with a Study Report based on survey conducted by GoI (copy enclosed) during Swachh Survekshan-2020.

According to their above assessment a large number of open dumps and GVPs have been found along the Ganga Ghats in ULBs mentioned in the Annexure enclosed.

You are therefore requested to kindly take necessary measures to identify & remove GVPs and open dumps near Ganga Ghats / along banks of River Ganga within your Municipal boundary in order to Clean Ganga River.

Swachh Survekshan - 2020, Assessment Report of Ganga Towns received from Ministry of Housing and Urban Affairs, Government of India is also attached herewith for your ready reference.

This may kindly be treated as most urgent and please also send an action taken report to this office at an early date. It may be kept in mind that Hon'ble NGT may take serious cognizance if the ULBs are found defaulter and indifferent in this regard.

After submission of Action Taken Report, team led by Engineers of SUDA will inspect the sites and report.

Enclo. : As stated

Yours faithfully,

Memo No.

Date.

Director, SUDA

Copy forwarded for kind information and necessary action to :-

- 1) Sri Tapas Kumar Gupta, Chief Engineer (SWM), West Bengal Pollution Control Board

Director, SUDA



Mailed
on 18/09/2020
Stom. W.C.C.B.

রাজ্য নগর উন্নয়ন সংস্থা

SUDA

STATE URBAN DEVELOPMENT AGENCY

“ইলগাস ভবন”, এইচ-সি ব্লক, সেক্টর-৩, বিধাননগর, কলকাতা-৭০০ ১০৬, পশ্চিমবঙ্গ
“ILGUS BHAVAN”, H-C Block, Sector - III, Bidhannagar, Kolkata - 700 106, West Bengal

ক্রমিক নং SUDA - 229/2018/1934

তারিখ 18.09.2020

From : Director, SUDA

To : Mr. Ankit Jain,
Asst. Adviser (PHE)
Ministry of Housing and Urban Affairs (CPHEEO)
Govt. of India

Sub. : Clean Ganga - immediate action required on the findings of Swachh Survekshan-2020 during the assessment of Ganga Towns - regarding.

Ref. : No.Q-16025/38/2018-CPHEEO Dt.-21.08.2020

Sir,

With reference to above and telephonic conversation with you on 16.09.2020, you are hereby requested to kindly share with us the locations map of GVP & open dump sites on Ghats & around Ganga river respectively related to concern municipalities as per your survey report.

We then in turn will share the same to the respective municipal authorities with a request to take necessary remedial measures to remove GVPs and open dumps on Ghats & around the river in order to keep the Ganga river clean.

Yours faithfully,

18.09.2020.
Director, SUDA

Memo No. SUDA-229/2018/1934/1(1)

Date. 18.09.20

Copy forwarded for kind information and necessary action to :-

- 1) Sri Tapas Kumar Gupta, Chief Engineer (SWM), West Bengal Pollution Control Board

18.09.2020.
Director, SUDA

দূরভাষ : ২৩৫৮ ৬৪০৩ / ৫৭৬৭, ফ্যাক্স : ২৩৫৮ ৫৮০০

Tel : 2358 6403/5767, Fax : 2358 5800, E-mail : wbsudadir@gmail.com

Account Section : 2358 6408

From : Director, SUDA

To
Mr. Ankit Jain,
Asst. Adviser (PHE)
Ministry of Housing and Urban Affairs (CPHEEO)
Govt. of India

Sub. : Clean Ganga - immediate action required on the findings of Swachh Survekshan-2020 during the assessment of Ganga Towns - regarding.

Ref. : No.Q-16025/38/2018-CPHEEO Dt.-21.08.2020

Sir,

With reference to above and telephonic conversation with you on 16.09.2020, you are hereby requested to kindly share with us the locations map of GVP & open dump sites on Ghats & around Ganga river respectively related to concerned municipalities as per your survey report.

We then in ^{turn will} share the same to the respective municipal authorities with a request to take necessary remedial measures to remove GVPs and open dumps on Ghats & around ^{the} river in order to keep ^{the} Ganga ^{the} River clean.

Yours faithfully,



Director, SUDA

URGENT ACTION

By e-mail only

No.Q-16025/38/2018-CPHEEO
Government of India
Ministry of Housing and Urban Affairs
(CPHEEO)

New Delhi, 21st August, 2020

OFFICE MEMORANDUM

Subject: Clean Ganga - Immediate action required on the findings of Swachh Survekshan-2020 during the assessment of Ganga Towns – regarding.

The undersigned is directed to refer to the **Swachh Survekshan 2020 – Assessment of 97 Ganga towns Report** released by the Ministry on 21/08/2020 during Award Ceremony of SS-2020 and to convey that a large number of open dumps and GVPs have been found along the Ganga Ghats in ULBs mentioned in the Annexure enclosed. **It is requested to urgently direct the officials concerned to remove GVPs and open dumps in the ULBs concerned in your respective States as immediate action for Clean Ganga and report back to this Ministry.** Swachh Survekshan 2020 – Assessment of 97 Ganga towns Report is available on the website <http://swachhbharaturban.gov.in/>. It is also attached.

(The assessment did not cover Barauni (Bihar), Pandit Deen Dayal Upadhyaya (Uttar Pradesh), Gayeshpur (West Bengal), Badrinath & Gangotri Dham (Uttarakhand))

Ankit Jain
21/08/2020
(Ankit Jain)

Asst. Adviser (PHE)

Tel: 011-23063581

ankit.j@nic.in

To

- 1) Mission Directors, SBM – Urban (Uttarakhand, Uttar Pradesh, Bihar, Jharkhand and West Bengal);
- 2) Project Directors – Clean Ganga SPMG (Uttarakhand, Uttar Pradesh, Bihar, Jharkhand and West Bengal);

Copy for information to:

National Mission Clean Ganga:

A. Director General, National Mission for Clean Ganga

Internal:

1. Advisor (PHEE)
2. Director (SBM & PHE)
3. JA (VKC) and JA (JBR)

West Bengal

Name of Town	No. of Ghats	Solid Waste spotted on river	GVP on or around Ghats	Open dump site around river
Haldia	2	0	0	0
Barrackpore	4	3	2	8
Maheshtala	1	3	2	0
Katwa	13	6	0	1
Halishahar	6	0	5	11
Nabadwip	3	2	1	3
Naihati	9	1	9	17
Bally	7	0	0	3
Howrah	5	0	2	1
Baidyabati	10	0	0	1
Kolkata	8	2	7	3
Titagarh	5	3	0	2
Khardah	10	7	1	3
Konnagar	5	1	4	8
Uluberia	5	0	0	4
Chandannagar	6	0	0	1
Uttarpara	5	0	3	4
Baranagar	8	10	3	11
Champdani	5	4	1	4
Bhadreshwar	2	0	0	0
Budge Budge	6	6	10	10
Panihati	32	14	9	30
Jiaganj- Azimganj	7	2	5	2
Kamarhati	7	1	0	5
Bhatpara	6	5	1	3
Hugli- Chinsurah	6	4	0	4
Kanchrapara	1	0	2	2
Diamond Harbour	3	0	6	4
Kalyani	4	1	4	2
Bansberia	6	4	0	2
Murshidabad	5	0	4	3
Rishra	6	6	0	4
Berhampore	13	12	10	7
Garulia	18	3	3	20
Jangipur	4	0	4	3
Serampore	9	6	1	4
Chakdah	1	2	2	2
Santipur	2	4	4	4
Dhulian	20	1	20	17
Total	275	113	125	213

রাজ্য নগর উন্নয়ন সংস্থা

STATE URBAN DEVELOPMENT AGENCY

“ইলগাস ভবন”, এইচ-সি ব্লক, সেক্টর-৩, বিধাননগর, কলকাতা-৭০০ ১০৬, পশ্চিমবঙ্গ

“ILGUS BHAVAN”, H-C Block, Sector - III, Bidhannagar, Kolkata - 700 106, West Bengal

ক্রমিক নং SUDA - 229/2018/10643

তারিখ 03.06.2020

From: Director, SUDA.

To: The Chairman,
Tamralipta Municipality,
Purba Mednipur.Sub: Sanction of fund for screening across channel/drain discharging to river Ganga
within Tamralipta Municipality.

Ref: Your Memo no: 1530 dated: 29.02.20

Sir,

In reference to the above this is to inform you that in the meeting, on Municipal Solid Waste Management and Monitoring of Ganga Towns, held on 10th July at SUDA Conference Hall, a decision has been taken that work related to screening on small nullah/drain up to the size of 1.2m x 1.2m to be executed by the Municipal Authority of its own. Reimbursement of funds for installation of screens above 1.2m x 1.2m may be claimed with work done estimate duly vetted by the concerned Executive Engineer of KMDA/M.E.Dte. The copy of the said minutes is being attached herewith for your ready reference please.

The rate analysis submitted by your good office are for the screens having size 1.2m x 1.2m, for each and every location. You are hereby again requested to execute the work immediately if not done till date and send a work done certificate for taking further necessary action.

Thanking you,

Yours faithfully,

Encl: As stated above

3.6.2020.

Director, SUDA

Don't

From: Director, SUDA.

To: The Chairman,
Tamralipta Municipality,
Purba Mednipur.

Sub: Sanction of fund for screening across channel/drain discharging to river Ganga
within Tamralipta Municipality.
Ref: Your Memo no: 1530 dated: 29.02.20

Sir,

In reference to the above this is to inform you that in the meeting, on Municipal Solid Waste Management and Monitoring of Ganga Towns, held on 10th July at SUDA Conference Hall, a decision has been taken that work related to screening on small nullah/drain up to the size of 1.2m x 1.2m to be executed by the Municipal Authority of its own. Reimbursement of funds for installation of screens above 1.2m x 1.2m may be claimed with work done estimate duly vetted by the concerned Executive Engineer of KMDA/M.E.Dte. The copy of the said minutes is being attached herewith for your ready reference please.

The rate analysis submitted by your good office are for the screens having size 1.2m x 1.2m, for each and every location. You are hereby again requested to execute the work immediately if not done till date and send a work done certificate for taking further necessary action.

Thanking you,

Yours faithfully,

Encl: As stated above

 3.6.2020.
Director, SUDA

By e-mail only

No.Q-16025/38/2018-CPHEEO
Government of India
Ministry of Housing and Urban Affairs
(CPHEEO)

New Delhi, 06th March, 2020

NOTICE FOR VIDEO CONFERENCE

Subject: Review of SWM progress in Ganga States and Towns via Video Conference on 16.03.2020 at 03.00 PM – regarding.

The undersigned is directed to inform that Video Conference on review of SWM State-wise in Ganga Towns by Joint Secretary (SBM) Shri Vinod Kumar Jindal has been scheduled for **16th March 2020 at 03:00 PM**, in Conference Room No. 417-C Wing, Nirman Bhawan and at respective NIC studios.

The Agenda for discussion during the VC:-

- (a) 100% Scientific Management of Municipal Solid Waste in Ganga Towns;
- (b) Status of open dump sites and GVPs along River Ganga;
- (c) Screening arrangements and their regular cleaning at all nallahs in Ganga Towns;
- (d) Regular Ghat Cleaning;
- (e) Anti littering messaging;
- (f) Progress in SBM-U matters

It is requested to make it convenient to participate in the Video Conference through nearest NIC Studio along with detailed status reports and action plans with targeted completion dates and present status.

Ankit Jain
(Ankit Jain) 06/03/2020
Asst. Adviser (PHE)
Tel: 011-23063581
ankit.j@nic.in

To

- 1) Mission Directors, SBM – Urban (Uttarakhand, Uttar Pradesh, Bihar, Jharkhand and West Bengal);
- 2) Project Directors – Clean Ganga SPMG (Uttarakhand, Uttar Pradesh, Bihar, Jharkhand and West Bengal);
- 3) Municipal Commissioners of the following Ganga ULBs in the State of Uttarakhand:-

i) Municipal Commissioner/ Ex. Officer Nagar Nigam Haridwar Mayapur, Near Fire Station Devpura, Haridwar - 249401 (Uttarakhand)	ii) Municipal Commissioner/ Ex. Officer Nagar Nigam Rishikesh, Haridwar Road, Near Kohli Market, Haridwar, Uttarakhand 249201
--	---

*Report
attached*

4) **Municipal Commissioners of the following Ganga ULBs in the State of Uttar Pradesh: -**

i) Municipal Commissioner Kanpur Nagar Nigam City Hall, Harsh Nagar, <u>Kanpur</u> , Uttar Pradesh 208002 mckanpur@yahoo.com	ii) Municipal Commissioner Varanasi Nagar Nigam Near Siga Sport Stadium, Siga, <u>Varanasi</u> , Uttar Pradesh 221002 nagarnigamvns@gmail.com
iii) Municipal Commissioner <u>Prayagraj (Allahabad)</u> Nagar Nigam 1, Sarojini Naidu Marg, Allahabad, Uttar Pradesh - 211 001	iv) Municipal Commissioner/ Ex. Officer Nagar Palika Parishad <u>Farrukhabad</u> , Town Hall, U P - 209601 eonppfarukhabadfr-up@nic.in
v) Ex. Officer Kannauj Nagar Palika Parishad Nagar Palika Chauraha, Safdarganj, Kannauj, Uttar Pradesh 209725	

5) **Municipal Commissioners of the following Ganga ULBs in the State of Bihar:-**

i) Municipal Commissioner Patna Municipal Corporation <u>Patna-800001</u> pmcprda@gmail.com	ii) Municipal Commissioner Bhagalpur Municipal Corporation, <u>Bhagalpur-812001</u> . nagarnigambhagalpur@gmail.com
iii) Municipal Commissioner Begusarai Municipal Corporation Chitragupta Nagar, <u>Begusarai</u> , Bihar-851101 bmcbe@gmail.com	

6) **Municipal Commissioners of the following Ganga ULBs in the State of West Bengal: -**

i) Municipal Commissioner Kolkata Municipal Corporation, S.S.N. Banerjee Road, Kolkata-700013	ii) Municipal Commissioner Howrah Municipal Corporation, 4, Mahatma Gandhi Road, Howrah-711101
---	--

Copy for information to:

Internal:

1. PPS to JS (SBM)
2. PPS to Advisor (PHEE)
3. Director (SBM & PHE)
4. JA (PHEE) – Dr. V.K. Chaurasia
5. JA (PHEE) – Shri J. B. Ravinder
6. NPMU (SBM) with the request to make arrangements for the Video Conference & Fact Sheets required. (Dr. Sanghamitra Bhattacharya)
7. Concerned officer (at room no. 535-C) to book the Conference Hall No. 417-C for the said VC on 16.03.2020 at 03:00 PM
8. Manager Bikano Café – To arrange water, Tea and Snacks for 12 persons

National Mission Clean Ganga:

- A. Director General, National Mission for Clean Ganga with the request for participation from NMCG in the VC.

Progress report regarding Solid Waste Management of Ganga Towns.

Sl. No.	Name of the Components	Status	Remarks
1.	100% Scientific Management of municipal Solid waste in Ganga Towns	9(Nine) waste processing plants at Baidyabati, Rishra, Srerampore, Konnagar, Uttarpara Kotrang, Champdany, Haldia, Kolkata MC and Krishnanagar are functioning at present including one no RWMC with SLF has been set up at Baidyabati, that caters six Ganga towns of Hooghly District. Upgradation of the plants has been proposed by the Transaction Advisors engaged for assisting State Govt. towards Scientific planning of SWM.	Transaction Advisors and Microplanners has been engaged for assisting State Govt. towards Scientific planning of SWM for each and every ULBs.
2.	Status of open dump sites and GVPs along River Ganga.	There are no open dump sites present along River Ganga. 1 (One) no GVP present at Naihaiti.	The removal of GVP is under prime consideration and will be removed within a short interval of time.
3.	Screening arrangements and their regular cleaning at all nullahs in Ganga Towns.	Out of 402 nos of drains discharging to River Ganga 400 nos of Drains on which screens have been provided and they are being cleaned at a regular interval. Two nos of Screens installation within Howrah MC are under Process.	List showing the name of the ULBs with details has been attached.
4.	Regular Ghat cleaning.	100% cleaning operation is being done by all the respective ULBs on regular basis. Bins have been provided on every Ghats.	
5.	Anti littering message	Anti littering message has been displayed on each and every Ghats.	
6.	Progress in SBM-U matters	ODF status Achieved- 33 nos of ULBs. Initial Target for IHHL construction- 210353 nos Revised Target for IHHL construction-62692 nos IHHL construction Completed=60818 nos (97%) IHHL Geo-tagging Completed-52633 nos Target for community Toilet block construction- 1631 nos Construction completed-1236 nos. Target for Public Toilet block construction- 522 nos Construction completed- 74 nos.	

Serial No.	Name of the Ganga Town	No. of Nallahs discharging into Ganga	Nallahs having screens	No. of Nallahs where Screens yet to be installed	Date for completing installation of Screens	How many screens are temporary?	Date for making screens permanent	Whether regular cleaning arrangement exists at all Screens	Remarks
1	Baidyabati	24	24	0	-	0	N. A.	Yes	
2	Bansberia	16	16	0	-	0	N. A.	Yes	
3	Baranagar	5	5	0	-	0	N. A.	Yes	
4	Barrackpore	2	2	0	-	0	N. A.	Yes	
5	Bhadreswar	6	6	0	-	0	N. A.	Yes	
6	Bhatpara	21	21	0	-	0	N. A.	Yes	
7	Budge Budge	3	3	0	-	0	N. A.	Yes	
8	Chakdah	0	0	0	-	-	-	-	
9	Chandernagore MC	9	9	0	-	0	N. A.	Yes	
10	Dhuliyani	13	13	0	-	0	N. A.	Yes	
11	Diamond Harbour	7	7	0	-	0	N. A.	Yes	
12	Gayeshpur	0	0	0	-	-	-	-	
13	Halisahar	11	11	0	-	0	N. A.	Yes	
14	Jangipur	16	16	0	-	0	N. A.	Yes	
15	Jiaganj-Azimganj	5	5	0	-	0	N. A.	Yes	
16	Kalyani	2	2	0	-	0	N. A.	Yes	
17	Kamarhati	11	11	0	-	0	N. A.	Yes	
18	Kanchrapara	0	0	0	-	0	N. A.	Yes	
19	Katwa	7	7	0	-	0	N. A.	Yes	
20	Khardah	12	12	0	-	0	N. A.	Yes	
21	Konnagar	6	6	0	-	0	N. A.	Yes	
22	Krishnanagar	0	0	0	It is not a Ganga Town	0	N. A.	Yes	
23	Murshidabad	8	8	0	-	0	N. A.	Yes	
24	Nabadwip	3	3	0	-	0	N. A.	Yes	
25	Naihati	4	4	0	-	0	N. A.	Yes	
26	North Barrackpore	11	11	0	-	0	N. A.	Yes	
27	Panihati	7	7	0	-	0	N. A.	Yes	
28	Pujali	2	2	0	-	0	N. A.	Yes	
29	Santipur	0	0	0	-	0	N. A.	Yes	
30	Serampore	15	15	0	-	0	N. A.	Yes	
31	Titagarh	3	3	0	-	0	N. A.	Yes	
32	Uttarpara-Kotrung	9	9	0	-	0	N. A.	Yes	
33	Rishra	4	4	0	-	0	N. A.	Yes	
34	Hooghly-Chinsurah	42	42	0	-	0	N. A.	Yes	
35	Uluberia	10	10	0	-	0	N. A.	Yes	
36	Maheshtala	10	10	0	-	0	N. A.	Yes	
37	Chamdpany	3	3	0	-	0	N. A.	Yes	
38	Berhampur	33	33	0	-	0	N. A.	Yes	
39	Garulia	10	10	0	31.10.2019	0	N. A.	Yes	
40	Haldia	8	8	0	13.02.2020	0	N. A.	Yes	
41	Kolkata MC	14	14	0	-	0	N. A.	Yes	
	TOTAL	372	372	0					
1	Howrah MC	30	28	2	-	0	N. A.	Yes	2 belongs to KMDA, 2nos under Irrigation Dept. As per Exe. Engg. all the works for installation of screen, has been awarded to KMDA & 2 nos screen has already been installed.
	TOTAL	30	28	2					
	GRAND TOTAL	402	400	2					

0.2

Sl No	Municipality	District	Compactor (Big)	Stn Compactor	Hook Loader	Compactor(s mall)	Dumper	FOT*	BIN				BHL*	
									10LT	120LT	240LT	FOT* BOT* TCV*		
1	Katwa	BARDDHAMAN	1				1	1	34400	10	8	0	0	0
2	Calcutta MC	CALCUTTA					0	0	0			0	0	0
3	Howrah MC	HOWRAH					0	0	117406	34	36	0	0	0
4	Uluberia	HOWRAH	2	1	1		1	2	103240	30	30	0	0	0
5	Baidyabati	HUGHLI	2				1	2	0	4	4	4	6	26
6	Bansberia	HUGHLI	2				1	2	36000	14	16	0	0	0
7	Bhadreswar	HUGHLI	2				1	2	53678	2	4	0	0	0
8	Chandannagore MC	HUGHLI	2				1	2	0	4	2	0	0	0
9	Hooghly Chinsurah	HUGHLI	2	1	1		1	2	82592	20	20	0	0	0
10	Konnagar	HUGHLI	1				1	1	92042	32	34	0	0	0
11	Rishra	HUGHLI	2				1	2	0	14	12	0	0	0
12	Serampore	HUGHLI	2				1	2	0	8	8	15	15	39
13	Uttarpara Kotrung	HUGHLI	2				1	2	0	8	10	0	0	0
14	Berhampore	HUGHLI	2				1	2	0	24	22	18	26	18
15	Dhuliyani	MURSHIDABAD	2				1	2	80000	12	12	0	0	0
16	Jangipur	MURSHIDABAD	2				1	2	40000	14	12	0	0	0
17	Jhaganj-Azimganj	MURSHIDABAD	1				1	2	20650	8	8	0	0	0
18	Murshidabad	MURSHIDABAD	1				1	1	23412	34	34	0	0	0
19	Chakdah	MURSHIDABAD	2				1	2	58840	20	22	0	0	0
20	Gayeshpur	NADIA	1				1	2	34000			0	0	0
21	Kalyani	NADIA	2				1	2	51144			9	26	38
22	Krishnanagar	NADIA	2				1	2	0			0	0	0
23	Nabadwip	NADIA	2				1	2	0			0	0	0
24	Santipur	NADIA	2				1	2	75156	4	4	0	0	0
25	Baranagar	NORTH 24-PARGANAS	4	1	1		1	2	80000	14	14	0	0	0
26	Barrackpore	NORTH 24-PARGANAS	2				1	2	75312	2	4	0	0	0
27	Bhatpara	NORTH 24-PARGANAS	2	1	1		1	2	0	28	26	0	0	0
28	Garulia	NORTH 24-PARGANAS	2				1	2	36600	14	14	0	0	0
29	Halisahar	NORTH 24-PARGANAS	2				1	2	20000	18	20	0	0	0
30	Kamarhati	NORTH 24-PARGANAS	2	1	1		1	2	190000	10	8	0	0	0

32	Kanchrapara	NORTH 24-PARGANAS	2							1	2	55952			0	0	0
33	Khardah	NORTH 24-PARGANAS	2							1	2	52000	12	12	0	0	0
34	Naihati	NORTH 24-PARGANAS	2	1	1					1	2	0	10	8	0	0	0
35	North Barrackpore	NORTH 24-PARGANAS	2							1	2	65128	14	16	0	0	0
36	Panihati	NORTH 24-PARGANAS	2	1	1					1	2	180000	36	34	0	0	0
37	Titagarh	NORTH 24-PARGANAS	2							1	2	33000	4	4	0	0	1
38	Haldia	PURBA MEDINIPUR	2					1		1	2	19680			0	0	0
39	Budge Budge	SOUTH 24-PARGANAS	1							1	1	29476	6	4	0	0	0
40	Diamond Harbour	SOUTH 24-PARGANAS	1							1	1	8200	2	4	0	0	0
41	Maheshtala	SOUTH 24-PARGANAS	3	1	1					1	2	209050	8	8	0	0	0
42	Pujali	SOUTH 24-PARGANAS	0							1	1	18600	6	4	0	0	0
TOTAL			74	8	8	12	40	72	2001048	496	526	46	73	121	15		

FOT= FUEL OPERATED TIPPER
 BOT=BATTERY OPERATED TIPPER
 TCV=TRI CYCLE VAN
 BHL= BACK HOE LOADER

IHHL Status of 42 Ganga Towns

Sl No	District	ULB	Initial Target	Final Revised Target	Construction completed	% of Construction Completion	Construction ongoing	Construction yet to start	No of Geo tagged IHHL as on 16.03.2020	% of Uploading against construction completion	No of Geo tag pending	Remarks
1	HOOGHLY	Baldyabati	1303	632	632	100.00	0	0	629	99.53	3	
2	HOOGHLY	Bansberia	2993	1140	1084	95.09	56	0	939	86.62	145	
3	HOOGHLY	Bhadreswar	3006	1200	1200	100.00	0	0	1200	100.00	0	
4	HOOGHLY	Chandany	2666	2315	1765	76.24	550	0	1609	91.16	156	
5	HOOGHLY	Chandannagore MC	2860	144	144	100.00	0	0	134	93.06	10	
6	HOOGHLY	Hooghly Chinsurah	6355	710	707	99.58	3	0	635	89.82	72	
7	HOOGHLY	Konnagar	409	47	47	100.00	0	0	47	100.00	0	
8	HOOGHLY	Rishra	1716	616	616	100.00	0	0	105	17.05	511	
9	HOOGHLY	Serampore	1821	582	547	93.99	35	0	496	90.68	51	
10	HOOGHLY	Uttarpara Kotrung	2409	183	183	100.00	0	0	149	81.42	34	
11	HOWRAH	Howrah MC	6822	0	0	0.00	0	0	0	0.00	0	
12	HOWRAH	Uluberia	8837	8670	8670	100.00	0	0	8670	100.00	0	
13	KOLKATA	Kolkata MC	68868	0	0	0.00	0	0	0	0.00	0	
14	MURSHIDABAD	Berhampore	1953	2837	2837	100.00	0	0	2837	100.00	0	
15	MURSHIDABAD	Dhulian	6104	7990	7843	98.16	147	0	7843	100.00	0	
16	MURSHIDABAD	Jangipur	2132	2702	2702	100.00	0	0	2702	100.00	0	
17	MURSHIDABAD	Jaganj-Azimganj	1888	2017	2017	100.00	0	0	1976	97.97	41	
18	MURSHIDABAD	Murshidabad	1221	1500	1500	100.00	0	0	1500	100.00	0	
19	NADIA	Chakdah	495	705	495	70.21	0	210	425	85.86	70	
20	NADIA	Gayeshpur	574	519	519	100.00	0	0	519	100.00	0	
21	NADIA	Kalyani	659	654	654	100.00	0	0	650	99.39	4	
22	NADIA	Krishnanagar	1736	1817	1817	100.00	0	0	1656	91.14	161	
23	NADIA	Nabadwip	2454	2454	2454	100.00	0	0	2454	100.00	0	
24	NADIA	Santipur	2629	2604	1852	71.12	0	752	1852	100.00	0	
25	NORTH 24-PGS	Baranagar	1355	516	516	100.00	0	0	516	100.00	0	
26	NORTH 24-PGS	Barrackpore	2115	335	300	89.55	0	35	300	100.00	0	
27	NORTH 24-PGS	Bhatpara	2346	1618	1574	97.28	44	0	1361	86.47	213	
28	NORTH 24-PGS	Garulia	1323	222	222	100.00	0	0	222	100.00	0	
29	NORTH 24-PGS	Halisahar	4507	163	163	100.00	0	0	163	100.00	0	
30	NORTH 24-PGS	Kamarhati	2621	342	300	87.72	42	0	289	96.33	11	
31	NORTH 24-PGS	Kanchrapara	1366	704	704	100.00	0	0	702	99.72	2	
32	NORTH 24-PGS	Khardah	908	208	208	100.00	0	0	186	89.42	22	

33	NORTH 24-PGS	Naihati	1520	1115	1115	100.00	0	0	428	38.39	687
34	NORTH 24-PGS	North Barrackpore	2132	302	302	100.00	0	0	302	100.00	0
35	NORTH 24-PGS	Panihati	4193	1000	1000	100.00	0	0	985	98.50	15
36	NORTH 24-PGS	Titagarh	440	440	440	100.00	0	0	409	92.95	31
37	Purba BARDHAMAN	Katwa	832	1232	1232	100.00	0	0	1232	100.00	0
38	PURBA MEDINIPUR	Haldia	2813	2813	2813	100.00	0	0	2549	90.62	264
39	SOUTH 24-PGS	Budge Budge	2707	977	977	100.00	0	0	796	81.47	181
40	SOUTH 24-PGS	Diamond Harbour	896	1595	1595	100.00	0	0	1595	100.00	0
41	SOUTH 24-PGS	Mahesthala	45658	6562	6562	100.00	0	0	1061	16.17	5501
42	SOUTH 24-PGS	Pujali	716	510	510	100.00	0	0	510	100.00	0
			210353	62692	60818	97.01	877	997	52633	86.54	8185

Community Toilet Status (in Block) for 42 Ganga Towns

Sl No	District	ULB	Initial Target	Revised Target	Constructed under MNB	Constructed other than MNB	Construction Ongoing	Yet to Start	Remarks
1	HOOGHLY	Baidyabati	40	40	40	0	0	0	
2	HOOGHLY	Bansberia	9	9	9	0	0	0	
3	HOOGHLY	Bhadreswar	0	0	0	0	0	0	
4	HOOGHLY	Champdany	13	13	13	0	0	0	
5	HOOGHLY	Chandannagore MC	5	5	0	0	0	5	
6	HOOGHLY	Hooghly Chinsurah	10	10	10	0	0	0	
7	HOOGHLY	Konnagar	0	0	0	0	0	0	
8	HOOGHLY	Rishra	2	2	2	0	0	0	
9	HOOGHLY	Serampore	12	12	12	0	0	0	
10	HOOGHLY	Uttarpara Kotrung	0	0	0	0	0	0	
11	HOWRAH	Howrah MC	210	465	450	15	0	0	
12	HOWRAH	Uluberia	33	33	30	0	3	0	
13	KOLKATA	Kolkata MC	769	769	573	0	46	150	
14	MURSHIDABAD	Berhampore	18	18	0	18	0	0	
15	MURSHIDABAD	Dhulian	47	47	0	0	0	47	
16	MURSHIDABAD	Jangipur	2	2	0	2	0	0	
17	MURSHIDABAD	Jiaganj-Azimganj	14	14	0	0	0	14	
18	MURSHIDABAD	Murshidabad	18	18	0	0	0	18	
19	NADIA	Chakdah	33	33	0	33	0	0	
20	NADIA	Gayeshpur	0	0	0	0	0	0	
21	NADIA	Kalyani	0	0	0	0	0	0	
22	NADIA	Krishnanagar	4	4	0	4	0	0	
23	NADIA	Nabadwip	0	0	0	0	0	0	
24	NADIA	Santipur	0	0	0	0	0	0	
25	NORTH 24-PGS	Baranagar	26	26	25	0	1	0	
26	NORTH 24-PGS	Barrackpore	0	0	0	0	0	0	
27	NORTH 24-PGS	Bhatpara	10	10	0	0	0	10	
28	NORTH 24-PGS	Garulia	0	0	0	0	0	0	
29	NORTH 24-PGS	Halisahar	14	14	14	0	0	0	
30	NORTH 24-PGS	Kamarhati	0	0	0	0	0	0	
31	NORTH 24-PGS	Kanchrapara	30	30	30	0	0	0	
32	NORTH 24-PGS	Khardah	0	0	0	0	0	0	
33	NORTH 24-PGS	Naihati	0	0	0	0	0	0	
34	NORTH 24-PGS	North Barrackpore	0	0	0	0	0	0	
35	NORTH 24-PGS	Panihati	0	0	0	0	0	0	
36	NORTH 24-PGS	Titagarh	0	0	0	0	0	0	
37	PURBA BARDHAMAN	Katwa	20	18	10	0	0	8	
38	PURBA MEDINIPUR	Haldia	0	0	0	0	0	0	
39	SOUTH 24-PGS	Budge Budge	18	18	18	0	0	0	
40	SOUTH 24-PGS	Diamond Harbour	8	21	0	13	0	8	
41	SOUTH 24-PGS	Maheshtala	0	0	0	0	0	0	
42	SOUTH 24-PGS	Pujali	0	0	0	0	0	0	
			1365	1631	1236	85	50	260	

Public Toilet Status (in Block) for 42 Ganga Towns

Sl No	District	ULB	Initial Target	Revised Target	Constructed under MNB	Constructed other than MNB	Construction Ongoing	Yet to Start	Remarks
1	HOOGHLY	Baidyabati	5	23	0	0	0	23	
2	HOOGHLY	Bansberia	0	0	0	0	0	0	
3	HOOGHLY	Bhadreswar	22	22	15	0	7	0	
4	HOOGHLY	Chamdpdany	20	28	0	0	20	8	
5	HOOGHLY	Chandannagore MC	0	0	0	0	0	0	
6	HOOGHLY	Hooghly Chinsurah	10	10	0	6	0	4	
7	HOOGHLY	Konnagar	0	0	0	0	0	0	
8	HOOGHLY	Rishra	0	0	0	0	0	0	
9	HOOGHLY	Serampore	3	3	0	0	0	3	
10	HOOGHLY	Uttarpara Kotrung	0	0	0	0	0	0	
11	HOWRAH	Howrah MC	200	206	50	12	120	24	
12	HOWRAH	Uluberia	0	0	0	0	0	0	
13	KOLKATA	Kolkata MC	0	0	0	0	0	0	
14	MURSHIDABAD	Berhampore	2	25	1	24	0	0	
15	MURSHIDABAD	Dhulian	47	47	0	0	0	47	
16	MURSHIDABAD	Jangipur	7	7	0	7	0	0	
17	MURSHIDABAD	Jiaganj-Azimganj	0	0	0	0	0	0	
18	MURSHIDABAD	Murshidabad	0	0	0	0	0	0	
19	NADIA	Chakdah	5	5	0	5	0	0	
20	NADIA	Gayeshpur	0	0	0	0	0	0	
21	NADIA	Kalyani	12	0	0	0	0	0	
22	NADIA	Krishnanagar	13	13	0	13	0	0	
23	NADIA	Nabadwip	40	40	0	40	0	0	
24	NADIA	Santipur	10	10	0	10	0	0	
25	NORTH 24-PGS	Baranagar	0	0	0	0	0	0	
26	NORTH 24-PGS	Barrackpore	0	0	0	0	0	0	
27	NORTH 24-PGS	Bhatpara	32	32	0	25	0	7	
28	NORTH 24-PGS	Garulia	0	0	0	0	0	0	
29	NORTH 24-PGS	Halisahar	3	3	0	3	0	0	
30	NORTH 24-PGS	Kamarhati	0	0	0	0	0	0	
31	NORTH 24-PGS	Kanchrapara	0	0	0	0	0	0	
32	NORTH 24-PGS	Khardah	0	0	0	0	0	0	
33	NORTH 24-PGS	Naihati	0	0	0	0	0	0	
34	NORTH 24-PGS	North Barrackpore	0	0	0	0	0	0	
35	NORTH 24-PGS	Panihati	0	0	0	0	0	0	
36	NORTH 24-PGS	Titagarh	0	10	0	10	0	0	
37	Purba BARDHAMAN	Katwa	10	6	0	6	0	0	
38	PURBA MEDINIPUR	Haldia	0	0	0	0	0	0	
39	SOUTH 24-PGS	Budge Budge	8	8	8	0	0	0	
40	SOUTH 24-PGS	Diamond Harbour	13	24	0	11	0	13	
41	SOUTH 24-PGS	Maheshtala	11	0	0	0	0	0	
42	SOUTH 24-PGS	Pujali	1	0	0	0	0	0	
			474	522	74	172	147	129	

75 ODF by 19.3
42 " " 7.4.

target in ODF + → all STP should work.
to treat fecal sludge.

FSSM policy should be there
Septic tank identity tensor should be tank.
All " " should be evacuated
Fecal matter should be transported
through GPS meters

Submit action Plan for ODF + for garbage
toner by 31.3.2020.

Give it to
N. K. Jindal
Sir.

City wise - Total Waste
How dry waste
Household waste
non-recyclable waste.
CFD waste plant should be there
How are you going to collect it.

Naitani - GVP Clean up
Screens → regular clean up
All dumpsite should be cleaned.

MIS portal → All up regularly.

→ for all

→ for garbage cities

(all screens to be
uploaded through
Geo tag)

Prepare time bound Action Plan.

তাম্রলিপ্ত পৌরসভা

OFFICE OF THE COUNCILLORS OF TAMRALIPTA MUNICIPALITY

স্থাপিত - ১৮৬৪ ❖ Estd. - 1864

তামলুক - পূর্ব মেদিনীপুর - ৭২১৬৩৬ ❖ TAMLUK - PURBA MEDINIPUR - 721636

Web: www.tamlukmunicipality.org ❖ e-mail : chairman@tamlukmunicipality.org

Phone:- (03228) 266007 / 267370 , Fax - (03228) 267370

প্রেরক From

পৌর প্রধান Chairman

তাম্রলিপ্ত পৌরসভা

Tamralipta Municipality

প্রতি To :



স্মারক/পত্রাঙ্ক নং Memo No.1530.....

তারিখ, তামলুক

Dated Tamluk, The...29.02.2020.....



C/M/M
PI.
19.03.2020

The Director,
State Urban Development Agency,
ILGUS Bhavan,
H.C. Block, Sector- III,
Bidhannagar, Kolkata- 700091.

Sub: Prayer for sanctioning the fund for construction of Screening Arrangement across the drain in different wards within Tamralipta Municipality.

Sir,

With reference to the above, I am sending herewith the drawing and vetted estimate amounting to Rs.- 7,51,753.00 (Rupees seven lakh fifty one thousand seven hundred fifty three) only, for your kind perusal.

I also undertake "Certified that the e-tender norms of the State Govt. as specified in Finance Department memo No.- 3060-F(y) dated 11.06.2014 and 3112-F(y) dated 13.06.2014 are being followed by the organization for its procurements".

Under the above circumstances, you are requested to sanction the fund for the purpose as early as possible.

Thanking you,
Encl: As stated above.

Yours faithfully,

(Sri R.N. Sen)
Chairman,
Tamralipta Municipality.

AE/ S. Chatterjee

Pl. 29/02/2020



ABSTRACT

Sl. No.	Description of Work	Amount Rs.
1	Construction of screening arrangement across the drain at Sayedpur in Ward No.- 02, at Ratnali and Radhaballavpur in Ward No.- 03 (drain No.- 01 & 02)	2,04,055.00
	(a) Construction of screening arrangement across the drain at Sayedpur in Ward No.- 02, at Ratnali in Ward No.- 03 . Rs.- 1,35,660.00	
	(b) Construction of screening arrangement across the drain at Radhaballavpur in Ward No. 03 . Rs.- 68,395.00	
2	Construction of screening arrangement across the drain at Padumbasan in Ward No.- 05, at U.C. Sankarara in Ward No.- 14, at Salgechia in Ward No.- 17, at Daharpur in Ward No.- 16, at Dharinda in Ward No.- 20 (drain No.- 03, 04, 06, 07 & 10)	1,71,068.00
	(a) Construction of screening arrangement across the drain at Padumbasan in Ward No.- 05. Rs.- 19,048.00	
	(b) Construction of screening arrangement across the drain at U.C. Sankarara in Ward No. 14. Rs.- 19,048.00	
	(c) Construction of screening arrangement across the drain at Salgechia in Ward No.- 17. Rs.- 19,048.00	
	(d) Construction of screening arrangement across the drain at Daharpur & Dharinda in Ward No.- 16 & 20. Rs.- 94,876.00	
	(e) Construction of screening arrangement across the drain at Sankarara in Ward No.- 17 . Rs.- 19,048.00	
3	Construction of screening arrangement across the drain at D.C. Sankarara in Ward No.- 15, 18 & 19 (drain No.- 05)	1,86,878.00
4	Construction of screening arrangement across the drain at D.C. Sankarara in Ward No.- 15, 18 & 19 (drain No.- 08 & 09)	1,89,752.00
	(a) Construction of screening arrangement across the drain at Kapasberia in Ward No.- 19. Rs.- 94,876.00	
	(b) Construction of screening arrangement across the drain at Kapasberia in Ward No.- 19. Rs.- 94,876.00	
	TOTAL AMOUNT RS.-	7,51,753.00

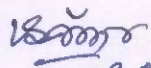
03.01.2020
K. PANJA
Sub-Assistant Engineer
Tamralipta Municipality

28/01/2020
Junior Engineer,
East Medinipur Division
(M.E. Dte.) Tamluk
Govt. of West Bengal

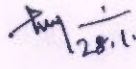
28.1.2020
Assistant Engineer,
East Medinipur Division
(M.E. Dte.) Tamluk
Govt. of West Bengal

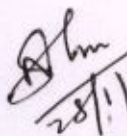
28/1/2020
Executive Engineer,
East Midnapur Division
M.E. Directorate
Govt. of West Bengal

TAMRALIPTA MUNICIPALITY
TAMLUK :: PURBA MEDINIPUR
DETAIL MEASUREMENTS AND CALCULATIONS

Detailed Estimate No. :-

for the year 200 to 200

Name of works :-

Estimate for Construction of Screening arrangement across the drain at Sayedpur in Ward No - 02 & at Ratnali in Ward No - 03, within Tamralipta Municipality

(Rate as per P. W. D. Schedule of Rates effected from 1st November 2017 & 3rd Corriganda w.e.f. 04.06.2018)

Sl. No.	Description of work	Unit	No	Length	Breadth	Height / Depth	Quantity	Rate	Amount
1	Page No - 01, Item No - 02 Earth work in excavation of foundation trenches drain, in all sorts of soil (including mixed soil spreading or stacking the spoils within a lead of 75m. as directed. The item includes and ramming the Bottombailing out water as required complete. a) Depth of excavation not exceeding 1500mm.	Cum	4	1.200	1.200	0.650	3.74	2.87	
		Cum	4	1.200	1.200	0.900	5.18	3.97	
	Total Qty.	Cum					8.92	119.27	815.81
									1063.89
2	Page No - 02, Item No - 04 Filling in foundation or plinth by silver sand in layers not exceeding 150mm. As directed and consolidating same by thorough saturation with water ramming complete, including the cost of supply of sand. (Payment to be made on measurement of finished quantity). a) Do-by fine sand	Cum	4	1.200	1.200	0.075	0.43		
	Total Qty.	Cum					0.43	543.51	179.36
							0.43		233.71
3	Page No - 23, Item No - 01 Cement concrete with graded Jhama Khoa (30mm size) excluding shuttering. In ground floor and foundation. (a) 6:3:1 proportion	Cum	4	1.200	1.200	0.075	0.43		
	Total Qty.	Cum					0.43	4306.87	1421.27
							0.43	4439.00	1908.77
4	Page No - 26, Item No - 10 Ordinary Cement concrete (mix 1:1.5:3) with graded stone chips (20 mm nominal size) excluding shuttering and reinforcement if any, in ground floor as per relevant IS codes	Cum	4	1.050	1.050	0.300	1.32		
	Total Qty.	Cum					0.49	5541.66	10030.40
							1.81	5777.32	10456.95

Estimate for Construction of Screening arrangement across the drain at Sayedpur in Ward No - 02 & at Ratnali in Ward No - 03, within Tamralipta Municipality

(Rate as per P. W. D. Schedule of Rates effected from 1st November 2017 & 3rd Corriganda w.e.f. 04.06.2018)

Sl. No.	Description of work	Unit	No	Length	Breadth	Height / Depth	Quantity	Rate	Amount
5	Page No - 42 , Item No - 36 Hire and labour charges for shuttering with centering and necessary staging upto 4m. using approved stout props and thick hard wood planks of approved thickness with required bracing for concrete slabs, beams, columns, lintels curved or straight including fitting, fixing and striking out after completion of works. (up to roof of ground floor) a) 25 mm to 30 mm thick wooden shuttering as per dicission direction of engineer in charge. i) In foundation & ground floor.	Sqm	16	1.050		0.300	5.04		
		Sqm	16	0.700		0.250	2.80		
	Total Qty.	Sqm					7.84	205.00	1607.20
6	Page No - 43 , Item No - 40 <i>(Rate Analysis)</i> Reinforcement for reinforced concrete work in the all sorts of structures including distribution bars, stirrups, binders etc. including supply of rods, initial straightening and removal of loose rust (if necessary)cutting to requisite length, hooking & bending to correct shape, placing in proper position and binding with 16 gauge black annealed wire at every intersection, complete as per drawing and direction. (a) For works in foundation, basement and upto roof of gr. floor / upto 4 m. (i) Tor steel / Mild steel. ;1% of Concrete Qty.	MT					0.142		
	Total Qty.	MT					0.142	52938.20	7547.22
7	Page No - 101, Item No - 01 <i>and 9rd, Corrigendum</i> M.S. structural works in columns, beams etc. with simple rolled structural members (e.g. joists, angle, channel sections conforming to IS: 226, IS: 808 & SP (6)- 1964 connected to one another with bracket, gussets, cleats as per design, direction of Engineer-incharge complete including cutting to requisite shape and length, fabrication with necessary bolting, metal arc welding conforming to IS: 816- 1969 & IS: 1995 using electrodes of approved make and brand conforming to IS:814- 2004, haulage, hoisting and erection all complete. The rate includes the cost of rolled steel section, consumables such as electrodes, gas and hire charge of all tools and plants and labour required for the work including all incidental chages such as electricity charges, labour insurance charges etc. <i>Structural Members</i> i) For Structural Works in Roof Trusses etc. using joists, channels and angles of specified section weighing less than 22.5 kg/ m	Kg	4	2.500		16.800	168.00		
		Kg	2	2.500		16.800	84.00		
		Kg	1	4.815		16.800	80.89		
		Kg	1	4.376 3.680		16.800	73.52 61.82		
		Kg	2	1.920		16.800	64.51		
		Kg	2	1.920		16.800	64.51		
	Total Qty.in Kg	Kg					527.73	-535.43	72603.00
	Total Qty.	MT					0.528	-0.535	32247.66
									38334.00

Estimate for Construction of Screening arrangement across the drain at Sayedpur in Ward No - 02 & at Ratnali in Ward No - 03, within Tamralipta Municipality

(Rate as per P. W. D. Schedule of Rates effected from 1st November 2017 & 3rd Corriganda w.e.f. 04.06.2018)

Sl. No.	Description of work	Unit	No	Length	Breadth	Height / Depth	Quantity	Rate	Amount
8	Page No - 104, Item No - 12 M.S. works in framed gratings of window etc.made of round or square bars and frame work or M.S. flats (with the bars securely fixed to the flat bar frame) with or without intermediate flat bar stiffener and fixed with necessary screws etc. complete, as directed. In ground floor.	Kg	2	2.500	2.500	35.000	438.00		
	4x0.5	Kg	4 x 1/2	1.603	1.057	35.000	237.00	118.61	
	Total Qty. <i>322</i>	Kg					675.00	66.99	45248.25
9	Page No - 45 , Item No - 06 <i>16.21 BWD Roads sch.</i> Cleaning the exposed reinforcement preferably upto full diameter by wire brush, applying two coats of polymer based rust removing compound left for 24 hours, removing the coating and then applying two (2) coats of polymer modified anti corrosive protective coating formulated to inhibit the corrosion of reinforcement as per manufacturer's specification] [Mode of measurement: The affected surface area of reinforcement shall be considered for payment]	Sqm	2	2.500	2.500		12.50		
		Sqm	4 x 1/2	1.603	1.057		13.00		
	Total Qty.	Sqm					7.00	3.39	
							20.00	506.00	8040.34
							15.89		15700.00
								Rs.	115953.65
	Add @ 12.00% SGST(6%) & CGST(6%)							Rs	13975.93
	Total Amount							Rs	130441.98
	Add @ 1.00% Labour welfare Cess							Rs	1304.42
	Add @ 3.00% Contengensis							Rs	3913.26
	Total							Rs	135659.66
								Rs.	135660.00

*Providing anti corrosive protective coating ...
... EIC*

Say **Rs. 135660.00** 135063.00
(Rupees one lakhs thirty five thousand six hundred sixty) only

K. PANJA
Sub-Assistant Engineer
Tamralipta Municipality

[Signature]
Chairman
Tamralipta Municipality

May be vetted
[Signature]
12/12/19
Junior Engineer,
East Medinipur Division
(M.E. Dte.) Tamluk
Govt. of West Bengal

May be vetted
[Signature]
12/12/19
Assistant Engineer,
East Medinipur Division
(M.E. Dte.) Tamluk
Govt. of West Bengal

vetted
[Signature]
12/12/19
Executive Engineer,
East Medinipur Division
(M.E. Dte.) Tamluk
Govt. of West Bengal

CROSS SECTION OF DRAIN - 1 AT SAYEDPUR IN WARD NO - 02 & RATNALI IN WRAD NO - 03 WITHIN TAMRALIPTA MUNICIPALITY

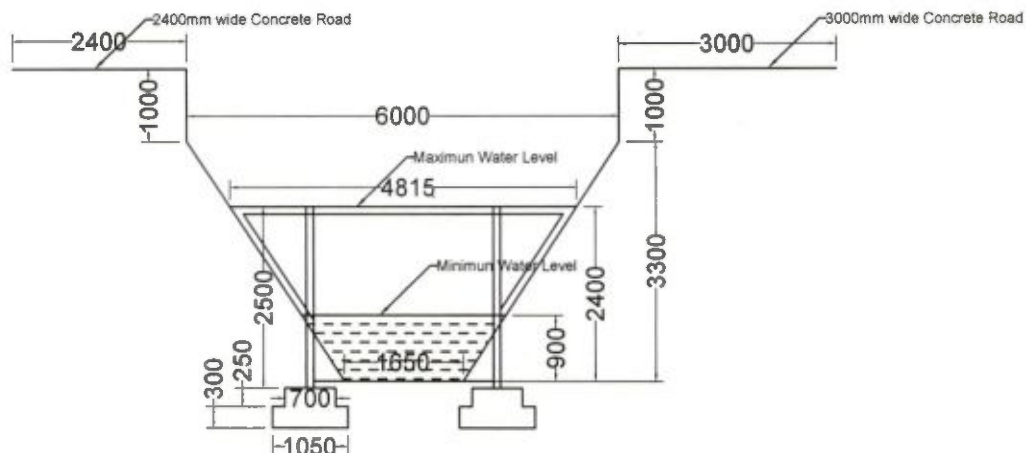

SECTIONAL PLAN OF DRAIN
(AT CHAINAGE 50M FROM OUT FALL POINT)

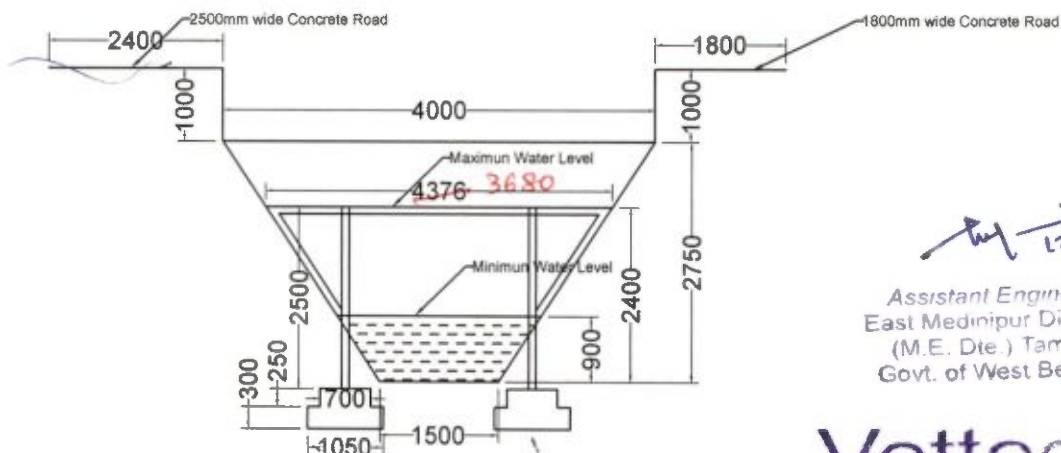

SECTIONAL PLAN OF DRAIN
(AT CHAINAGE 50M FROM OUT FALL POINT)

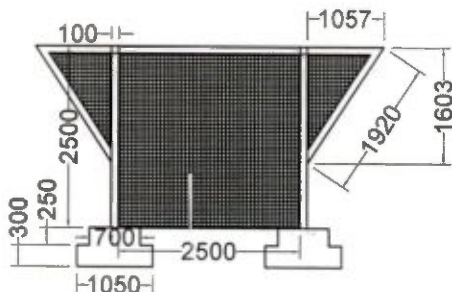

SECTIONAL PLAN OF GRATING

12/12/19
 Assistant Engineer,
 East Medinipur Division
 (M.E. Dte.) Tamiuk
 Govt. of West Bengal

Vetted
[Signature]
 Executive Engineer,
 East Medinipur Division
 (M.E. Dte.) Tamiuk
 Govt. of West Bengal

[Signature]
K. PANJA
 Sub-Assistant Engineer
 Tamralipta Municipality

TAMRALIPTA MUNICIPALITY
TAMLUK :: PURBA MEDINIPUR
DETAIL MEASUREMENTS AND CALCULATIONS

Detailed Estimate No. :-
Name of works :-

for the year 200 to 200

Estimate for Construction of Screening arrangement across the drain at Radhaballavpur in Ward No - 03, within Tamralipta Municipality

(Rate as per P. W. D. Schedule of Rates effected from 1st November 2017 & 3rd Corriganda w.e.f. 04.06.2018)

Sl. No.	Description of work	Unit	No	Length	Breadth	Height / Depth	Quantity	Rate	Amount
1	Page No - 01, Item No - 02 Earth work in excavation of foundation trenches drain, in all sorts of soil (including mixed soil spreading or stacking the spoils within a lead of 75m. as directed. The item includes and ramming the Bottombailing out water as required complete. a) Depth of excavation not exceeding 1500mm.	Cum	2	1.200 ^{1.05}	1.200 ^{1.05}	0.650	1.87 ^{1.43}		
		Cum	2	1.200 ^{1.05}	1.200 ^{1.05}	0.900	2.59 ^{1.98}		
	Total Qty.	Cum		1.05 ^{1.05}	1.05 ^{1.05}		4.46 ^{3.41}	119.27	406.71 ^{531.94}
2	Page No - 02, Item No - 04 Filling in foundation or plinth by silver sand in layers not exceeding 150mm. As directed and consolidating same by thorough saturation with water ramming complete, including the cost of supply of sand. (Payment to be made on measurement of finished quantity). a) Do-by fine sand	Cum	2	1.200 ^{1.05}	1.200 ^{1.05}	0.075	0.22 ^{0.16}		
	Total Qty.	Cum		1.05 ^{1.05}	1.05 ^{1.05}		0.22 ^{0.16}	543.51	119.57 ^{86.96}
3	Page No - 23, Item No - 01 Cement concrete with graded Jhama Khoa (30mm size) excluding shuttering. In ground floor and foundation. (a) 6:3:1 proportion	Cum	2	1.200 ^{1.05}	1.200 ^{1.05}	0.075	0.22 ^{0.16}		
	Total Qty.	Cum		1.05 ^{1.05}	1.05 ^{1.05}		0.22 ^{0.16}	4306.87	689.11 ^{976.58}
4	Page No - 26, Item No - 10 Ordinary Cement concrete (mix 1:1.5:3) with graded stone chips (20 mm nominal size) excluding shuttering and reinforcement if any, in ground floor as per relevant IS codes	Cum	2	1.050	1.050	0.300	0.66		
		Cum	2	0.700	0.700	0.250	0.25		
	Total Qty.	Cum					0.91	5541.66	5041.91
								5777.32	6257.36

Estimate for Construction of Screening arrangement across the drain at Radhaballavpur in Ward No - 03, within Tamralipta Municipality

Rate as per P. W. D. Schedule of Rates effected from 1st November 2017 & 3rd Corriganada w.e.f. 04.06.2018)

Sl. No.	Description of work	Unit	No	Length	Breadth	Height / Depth	Quantity	Rate	Amount
---------	---------------------	------	----	--------	---------	----------------	----------	------	--------

5 Page No - 42 , Item No - 36
 Hire and labour charges for shuttering with centering and necessary staging upto 4m. using approved stout props and thick hard wood planks of approved thickness with required bracing for concrete slabs, beams, columns, lintels curved or straight including fitting, fixing and striking out after completion of works. (up to roof of ground floor)
 (When the height of a particular floor is more than 4m. the equivalent floor ht. Shall be taken as 4m. and extra for works beyond the initial 4m. ht. Shall be allowed under 12(e) for every 4m. or part thereof.)
 a) 25 mm to 30 mm thick wooden shuttering as per dicission direction of engineer in charge.
 i) In foundation & ground floor.

Sqm	8	1.050	0.300	2.52		
Sqm	8	0.700	0.250	1.40		
Total Qty.	Sqm			3.92	205.00	803.60

6 Page No - 43 , Item No - 40 *Rate analysis*
 Reinforcement for reinforced concrete work in the all sorts of structures including distribution bars, stirrups, binders etc. including supply of rods, initial straightening and removal of loose rust (if necessary)cutting to requisite length, hooking & bending to correct shape, placing in proper position and binding with 16 gauge black annealed wire at every intersection, complete as per drawing and direction.
 (a) For works in foundation, basement and upto roof of ground floor / upto 4 m.
 (i) Tor steel / Mild steel.

;1% of Concrete Qty.	MT			0.071	48785.87	3463.80
Total Qty.	MT			0.071	52938.20	3758.61

7 Page No - 101, Item No - 01 *2nd Corri'*
 M.S. structural works in columns, beams etc. with simple rolled structural members (e.g. joists, angle, channel sections conforming to IS: 226, IS: 808 & SP (6)- 1964 connected to one another with bracket, gussets, cleats as per design, direction of Engineer-incharge complete including cutting to requisite shape and length, fabrication with necessary bolting, metal arc welding conforming to IS: 816- 1969 & IS: 1995 using electrodes of approved make and brand conforming to IS:814- 2004, haulage, hoisting and erection all complete. The rate includes the cost of rolled steel section, consumables such as electrodes, gas and hire charge of all tools and plants and labour required for the work including all incidental chages such as electricity charges, labour insurance charges etc.
 II) For Structural Works in Roof Trusses etc. using joists, channels and angles of specified section weighing less than 22.5 kg/ m

	Kg	2	2.500	16.800	84.00	
	Kg	1	2.500	16.800	42.00	
	Kg	1	4.815	16.800	80.89	
	Kg	2	1.920	16.800	64.51	
Total Qty.in Kg	Kg			271.40	72603.80	19675.41
Total Qty.	MT			0.271	60276.00	46334.80

Estimate for Construction of Screening arrangement across the drain at Radhaballavpur in Ward No - 03, within Tamralipta Municipality

Rate as per P. W. D. Schedule of Rates effected from 1st November 2017 & 3rd Corriganda w.e.f. 04.06.2018)

Sl. No.	Description of work	Unit	No	Length	Breadth	Height / Depth	Quantity	Rate	Amount
---------	---------------------	------	----	--------	---------	----------------	----------	------	--------

8	Page No - 104, Item No - 12 M.S. works in framed gratings of window etc.made of round or square bars and frame work or M.S. flats (with the bars securely fixed to the flat bar frame) with or without intermediate flat bar stiffener and fixed with necessary screws etc. complete, as directed. In ground floor.	Kg	21	2.500	2.500	35.000	438.00	218.75	
	4x0.5	Kg	4 2x 1/2	1.603	1.057	35.000	237.00	59.30	
	Total Qty.	Kg					675.00	66.99	45218.25
9	Page No - 45, Item No - 06 Cleaning the exposed reinforcement preferably upto full diameter by wire brush, applying two coats of polymer based rust removing compound left for 24 hours, removing the coating and then applying two (2) coats of polymer modified anti corrosive protective coating formulated to inhibit the corrosion of reinforcement as per manufacturer's specification] [Mode of measurement: The affected surface area of reinforcement shall be considered for payment]	Sqm	1	2.500	2.500		6.00	6.25	
		Sqm	2 2x 1/2	1.603	1.057		3.00	1.69	4017.64
	Total Qty.	Sqm					9.00	785.00	7065.00
							7.94		
								Rs.	80065.71
	Add @ 12.00% SGST(6%) & CGST(6%)							Rs	9607.89
	Total Amount							Rs	89673.60
	Add @ 1.00% Labour welfare Cess							Rs	896.74
	Add @ 3.00% Contengensis							Rs	2690.21
	Total							Rs	93260.54

*Providing anti Corrosive Protection coating...
... EIC*

Say Rs. 68395.00 93261.00
(Rupees sixty eight thousand three hundred ninety five) only

K. PANJA
Sub-Assistant Engineer
Tamralipta Municipality

[Signature]
Chairman
Tamralipta Municipality

May be vetted
[Signature]
12/12/19
Junior Engineer,
East Medinipur Division
(M.E. Dte.) Tamluk
Govt. of West Bengal

May be vetted.
[Signature]
12/12/19
Assistant Engineer,
East Medinipur Division
(M.E. Dte.) Tamluk
Govt. of West Bengal

vetted
[Signature]
12/12/19
Executive Engineer,
East Medinipur Division
(M.E. Dte.) Tamluk
Govt. of West Bengal

CROSS SECTION OF DRAIN - 2 AT RADHABALLAVPUR IN WRAD N0 - 03 WITHIN TAMRALIPTA MUNICIPALITY

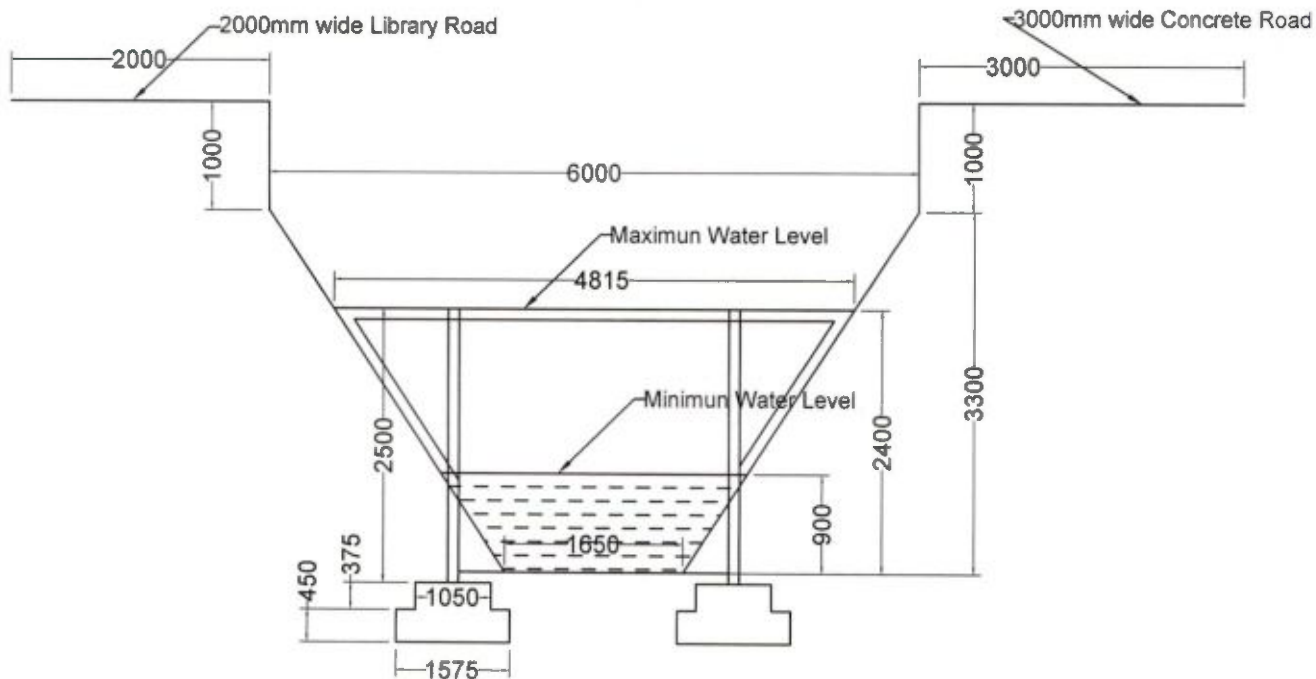

SECTIONAL PLAN OF DRAIN
(AT CHAINAGE 75M FROM OUT FALL POINT)

[Signature]
2/12/19
Assistant Engineer,
East Medinipur Division
(M.E. Dte.) Tamluk
Govt. of West Bengal

Vetted

[Signature]
2/12/19

Executive Engineer,
East Medinipur Division
(M.E. Dte.) Tamluk
Govt. of West Bengal

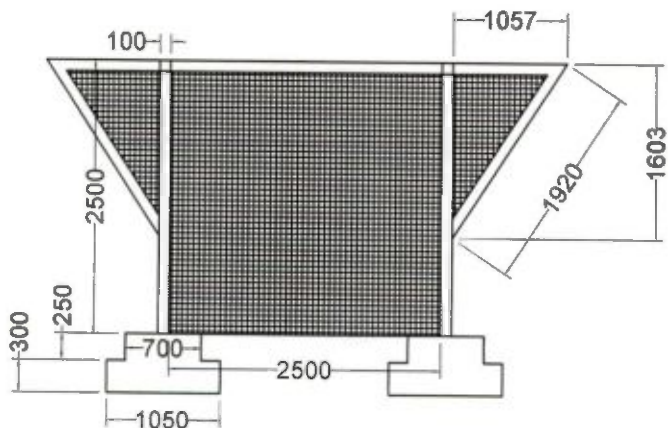

SECTIONAL PLAN OF GRATING

[Signature]

K. PANJA
Sub-Assistant Engineer
Tamralipta Municipality

TAMRALIPTA MUNICIPALITY
TAMLUK :: PURBA MEDINIPUR
DETAIL MEASUREMENTS AND CALCULATIONS

Detailed Estimate No. :-
 Name of works :-

for the year 200 to 200

Estimate for Construction of Screening arrangement across the drain at Padumbasan in Ward No - 05, within Tamralipta Municipality

(Rate as per P. W. D. Schedule of Rates effected from 1st November 2017 & 3rd Corriganda w.e.f. 04.06.2018)

Sl. No.	Description of work	Unit	No	Length	Breadth	Height / Depth	Quantity	Rate	Amount
1	Page No - 10, Item No - 01 Dismantling all types of masonry excepting cement concrete plain or reinforced, stacking serviceable materials at site and removing rubbish as directed within a lead of 75 m. a) In ground floor including roof.	Cum	2	0.150	0.100	1.500	0.05		
	Total Qty.	Cum					0.05	447.00	22.35
2	Page No - 10, Item No - 02 Dismantling all types of plain cement concrete works, stacking serviceable materials at site and removing rubbish as directed within a lead of 75m. In ground floor including roof. (a) upto 150 mm. thick	Cum	2	1.500	0.150	0.150	0.07		
	Total Qty.	Cum					0.07	939.00	65.73
3	Page No - 26, Item No - 10 Ordinary Cement concrete (mix 1:1.5:3) with graded stone chips (20 mm nominal size) excluding shuttering and reinforcement if any, in ground floor as per relevant IS codes	Cum	2	1.500	0.150	0.125	0.07		
	Total Qty.	Cum					0.06	5541.66	387.92
							0.06	5777.32	346.64
4	Page No - 101, Item No - 01 M.S. structural works in columns, beams etc. with simple rolled structural members (e.g. joists, angle, channel sections conforming to IS: 226, IS: 808 & SP (6)- 1964 connected to one another with bracket, gussets, cleats as per design, direction of Engineer-in-charge complete including cutting to requisite shape and length, fabrication with necessary bolting, metal arc welding conforming to IS: 816- 1969 & IS: 1995 using electrodes of approved make and brand conforming to IS:814- 2004, haulage, hoisting and erection all complete. The rate includes the cost of rolled steel section, consumables such as electrodes, gas and hire charge of all tools and plants and labour required for the work including all incidental chages such as electricity charges, labour insurance charges etc. II) For Structural Works in Roof Trusses etc. using joists, channels and angles of specified section weighing less than 22.5 kg/ m	Kg	2	1.500		16.800	50.40		
	Total Qty.in Kg	Kg				16.800	55.44	57.12	
	Total Qty.	MT					105.84	107.52	
							0.106	60276.00	6389.26
							0.107	72603.00	7768.52

Estimate for Construction of Screening arrangement across the drain at Padumbasan in Ward No - 05, within Tamralipta Municipality

(Rate as per P. W. D. Schedule of Rates effected from 1st November 2017 & 3rd Corriganda w.e.f. 04.06.2018)

Sl. No.	Description of work	Unit	No	Length	Breadth	Height / Depth	Quantity	Rate	Amount
---------	---------------------	------	----	--------	---------	----------------	----------	------	--------

5 Page No - 104, Item No - 12
 M.S. works in framed gratings of window etc.made of round or square bars and frame work or M.S. flats (with the bars securely fixed to the flat bar frame) with or without intermediate flat bar stiffener and fixed with necessary screws etc. complete, as directed.
 In ground floor.

	Kg	1	1.500	1.500	35.000	79.00		6970.17
Total Qty.	Kg					79.00	88.23	5292.21

9 Page No - 45, Item No - 06 16.21 *RWD Road side*
 Cleaning the exposed reinforcement preferably upto full diameter by wire brush, applying two coats of polymer based rust removing compound left for 24 hours, removing the coating and then applying two (2) coats of polymer modified anti corrosive protective coating formulated to inhibit the corrosion of reinforcement as per manufacturer's specification] [Mode of measurement: The affected surface area of reinforcement shall be considered for payment]

*providing anti corrosion protective coating...
 --- ETC*

	Sqm	1	1.500	1.500		2.25		1138.50
Total Qty.	Sqm					2.00	506.00	1570.00
						2.25		13686.19

Add @ 12.00% SGST(6%) & CGST(6%)	Rs						1962.38	1642.34
Total Amount	Rs						18315.37	15328.53
Add @ 1.00% Labour welfare Cess	Rs						183.16	153.29
Add @ 3.00% Contengensis	Rs						549.47	459.86
Total	Rs						19048.20	15941.67

Say **Rs. 19048.00** 15942.00
(Rupees nineteen thousand forty eight) only

K. PANJA
 Sub-Assistant Engineer
 Tamralipta Municipality
Chairman
 Tamralipta Municipality

May be vetted
Pay
 12/12/19
 Junior Engineer,
 East Medinipur Division
 (M.E. Dte.) Tamluk
 Govt. of West Bengal

May be vetted.
 12/12/19
 Assistant Engineer,
 East Medinipur Division
 (M.E. Dte.) Tamluk
 Govt. of West Bengal

Vetted
Abh
 12/12/19
 Executive Engineer,
 East Medinipur Division
 (M.E. Dte.) Tamluk
 Govt of West Bengal

CROSS SECTION OF DRAIN - 3 AT PADUMBASAN IN WRAD NO - 05 WITHIN TAMRALIPTA MUNICIPALITY

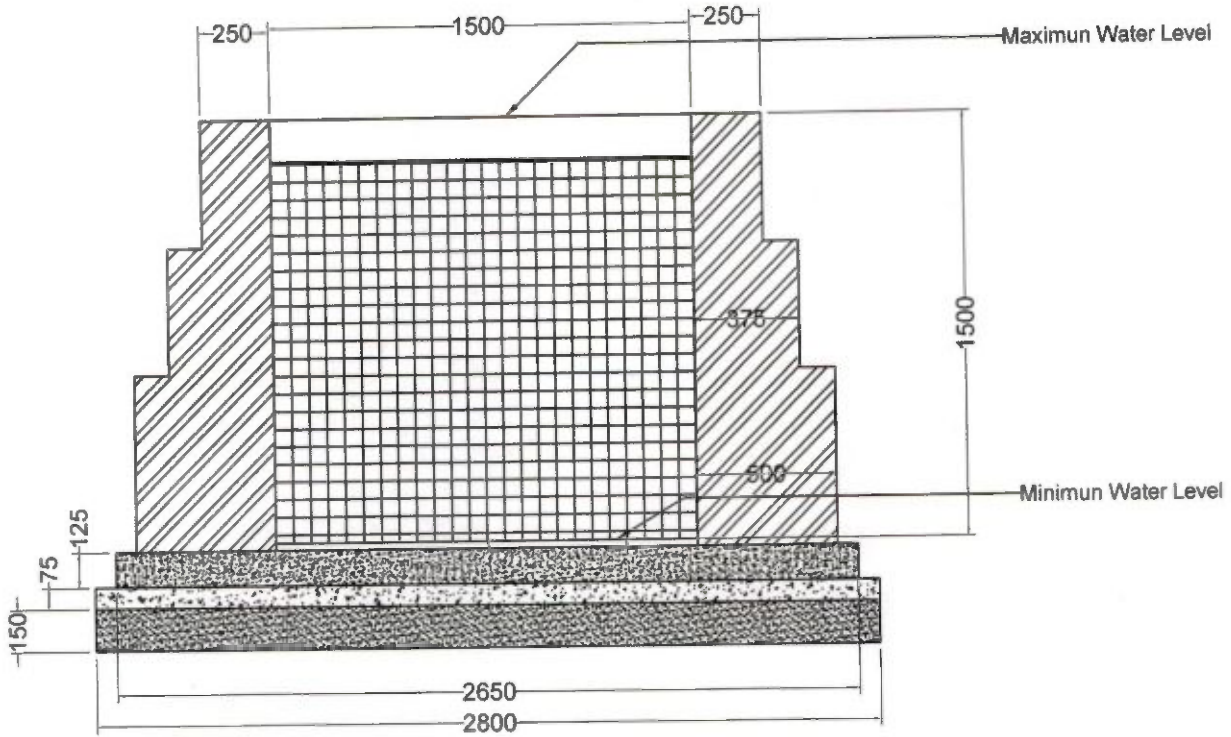

SECTIONAL PLAN OF DRAIN
(AT CHAINAGE 75M FROM OUT FALL POINT)

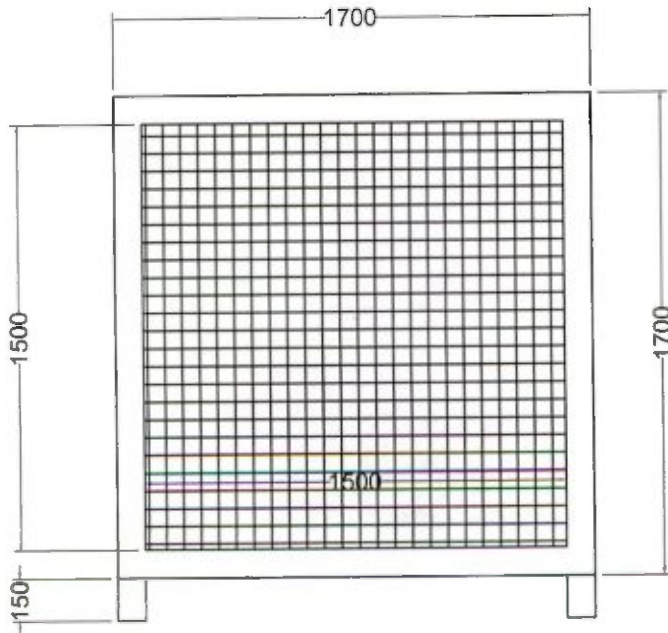

SECTIONAL PLAN OF GRATING

[Signature] 12/12/19
 Assistant Engineer,
 East Medinipur Division
 (M.E. Dte.) Tamluk
 Govt. of West Bengal

Vetted

[Signature] 12/12/19
 Executive Engineer,
 East Medinipur Division
 (M.E. Dte.) Tamluk
 Govt. of West Bengal

[Signature] 10.12.19
K. PANJA
 Sub-Assistant Engineer
 Tamralipta Municipality

Page-21
Drain-4

TAMRALIPTA MUNICIPALITY
TAMLUK :: PURBA MEDINIPUR
DETAIL MEASUREMENTS AND CALCULATIONS

Detailed Estimate No. :-
 Name of works :-

for the year 200 to 200

**Estimate for Construction of Screening arrangement across the drain at Uttar Chara Sankarara
 in Ward No - 14, within Tamralipta Municipality**

(Rate as per P. W. D. Schedule of Rates effected from 1st November 2017 & 3rd Corriganda w.e.f. 04.06.2018)

Sl. No.	Description of work	Unit	No	Length	Breadth	Height / Depth	Quantity	Rate	Amount
1	Page No - 10, Item No - 01 Dismantling all types of masonry excepting cement concrete plain or reinforced, stacking serviceable materials at site and removing rubbish as directed within a lead of 75 m. a) In ground floor including roof.	Cum	2	0.150	0.100	1.500	0.05		
	Total Qty.	Cum					0.05	447.00	22.35
2	Page No - 10, Item No - 02 Dismantling all types of plain cement concrete works, stacking serviceable materials at site and removing rubbish as directed within a lead of 75m. In ground floor including roof. (a) upto 150 mm. thick	Cum	2	1.500	0.150	0.150	0.07		
	Total Qty.	Cum					0.07	939.00	65.73
3	Page No - 26, Item No - 10 Ordinary Cement concrete (mix 1:1.5:3) with graded stone chips (20 mm nominal size) excluding shuttering and reinforcement if any, in ground floor as per relevant IS codes	Cum	2	1.500	0.150	0.125	0.06		
	Total Qty.	Cum					0.06	5541.66	387.92
4	Page No - 101, Item No - 01 M.S. structural works in columns, beams etc. with simple rolled structural members (e.g. joists, angle, channel sections conforming to IS: 226, IS: 808 & SP (6)- 1964 connected to one another with bracket, gussets, cleats as per design, direction of Engineer-in-charge complete including cutting to requisite shape and length, fabrication with necessary bolting, metal arc welding conforming to IS: 816- 1969 & IS: 1995 using electrodes of approved make and brand conforming to IS:814- 2004, haulage, hoisting and erection all complete. The rate includes the cost of rolled steel section, consumables such as electrodes, gas and hire charge of all tools and plants and labour required for the work including all incidental chages such as electricity charges, labour insurance charges etc. II) For Structural Works in Roof Trusses etc. using joists, channels and angles of specified section weighing less than 22.5 kg/ m	Kg	2	1.500			50.40		
	Total Qty.in Kg	Kg					50.40		
	Total Qty.	MT					55.44	5712	
							105.84	107.52	7768.52
							0.106	60276.00	6389.26
							0.07	72603.00	

Estimate for Construction of Screening arrangement across the drain at Uttar Chara Sankarara in Ward No - 14, within Tamralipta Municipality

(Note as per P. W. D. Schedule of Rates effected from 1st November 2017 & 3rd Corriganada w.e.f. 04.06.2018)

Sl. No.	Description of work	Unit	No	Length	Breadth	Height / Depth	Quantity	Rate	Amount
---------	---------------------	------	----	--------	---------	----------------	----------	------	--------

5 Page No - 104, Item No - 12
 M.S. works in framed gratings of window etc.made of round or square bars and frame work or M.S. flats (with the bars securely fixed to the flat bar frame) with or without intermediate flat bar stiffener and fixed with necessary screws etc. complete, as directed.
 In ground floor.

	Kg	1	1.500	1.500	35.000	79.00			
Total Qty.	Kg					79.00	38.23	6970.17	
							66.99	5292.21	

9 Page No - 45, Item No - 06-16.21 PWD Roads sh
 Cleaning the exposed reinforcement preferably upto full diameter by wire brush, applying two coats of polymer based rust removing compound left for 24 hours, removing the coating and then applying two (2) coats of polymer modified anti corrosive protective coating formulated to inhibit the corrosion of reinforcement as per manufacturer's specification] [Mode of measurement: The affected surface area of reinforcement shall be considered for payment]

Providing anti corrosive protective coating --- BIC

	Sqm	1	1.500	1.500		2.00			
Total Qty.	Sqm					2.00	506.00	1138.00	
							785.00	4570.00	

Add @ 12.00% SGST(6%) & CGST(6%) Rs 1962.38 1642.34
 Total Amount Rs 18315.57 15328.53
 Add @ 1.00% Labour welfare Cess Rs 183.16 153.29
 Add @ 3.00% Contengensis Rs 549.47 459.86
Total Rs 19048.20 15941.67

Say Rs. 19048.00 15942.00

(Rupees nineteen thousand forty eight) only

K. PANJA
 Sub-Assistant Engineer
 Tamralipta Municipality

Chairman
 Tamralipta Municipality

Vetted

May be vetted
Pay
 Junior Engineer,
 East Medinipur Division
 (M.E. Dte.) Tamluk
 Govt. of West Bengal

May be vetted.
 Assistant Engineer,
 East Medinipur Division
 (M.E. Dte.) Tamluk
 Govt. of West Bengal

Executive Engineer,
 East Medinipur Division
 (M.E. Dte.) Tamluk
 Govt. of West Bengal

CROSS SECTION OF DRAIN - 4 AT UTTAR CHARA SANKARARA IN WRAD NO - 14 WITHIN TAMRALIPTA MUNICIPALITY

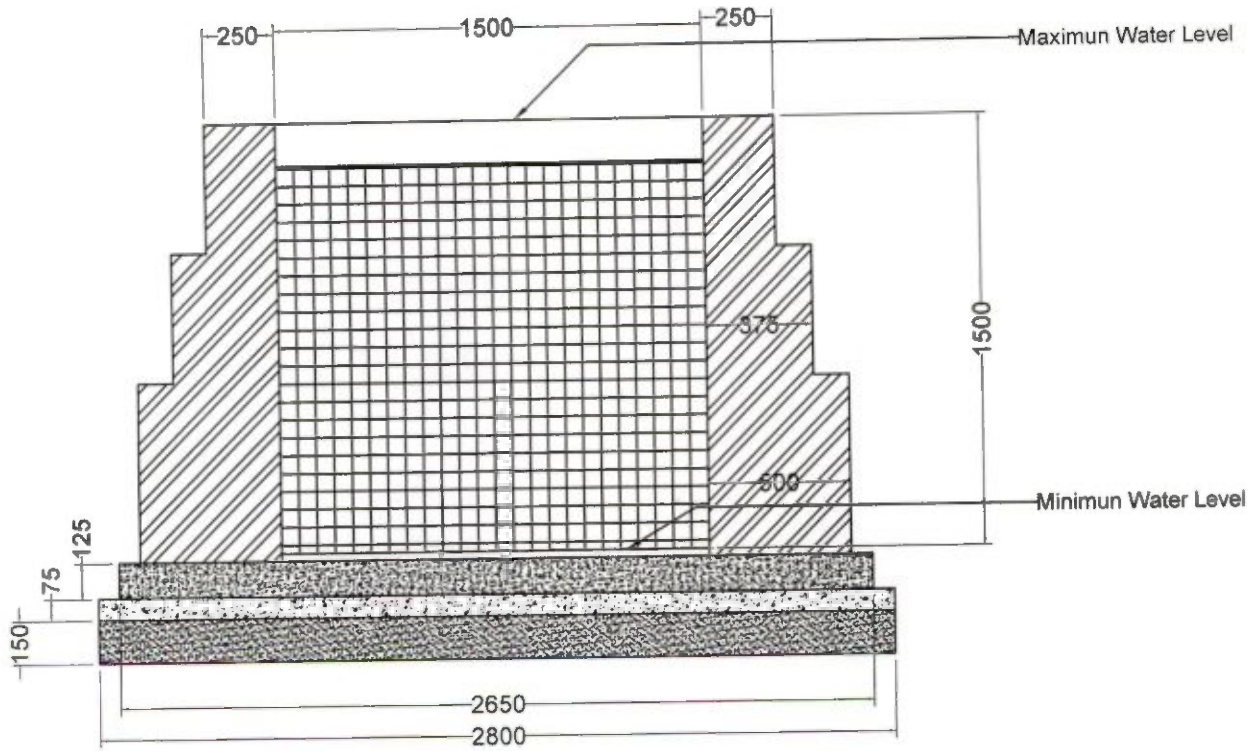

SECTIONAL PLAN OF DRAIN (AT CHAINAGE 75M FROM OUT FALL POINT)

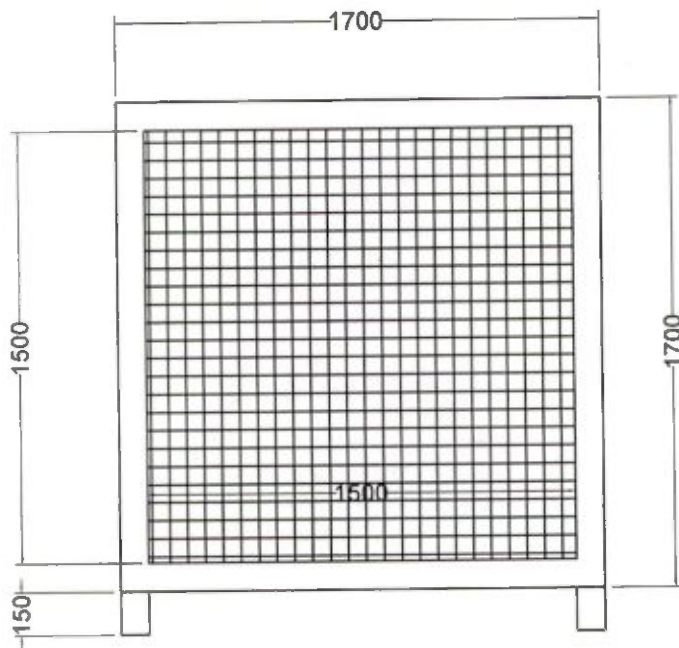

SECTIONAL PLAN OF GRATING

[Signature]
12/12/19
Assistant Engineer,
East Medinipur Division
(M.E. Dte.) Tamiuk
Govt. of West Bengal

Vetted
[Signature]
12/12/19
Executive Engineer,
East Medinipur Division
(M.E. Dte.) Tamiuk
Govt. of West Bengal

[Signature]
10/12/19
K. PANJA
Sub-Assistant Engineer
Tamralipta Municipality

Page-26
Drawn-6

TAMRALIPTA MUNICIPALITY
TAMLUK :: PURBA MEDINIPUR
DETAIL MEASUREMENTS AND CALCULATIONS

Detailed Estimate No. :-
Name of works :-

for the year 200 to 200

Estimate for Construction of Screening arrangement across the drain at Salgechhia in Ward No - 17, within Tamralipta Municipality

(Rate as per P. W. D. Schedule of Rates effected from 1st November 2017 & 3rd Corriganda w.e.f. 04.06.2018)

Sl. No.	Description of work	Unit	No	Length	Breadth	Height / Depth	Quantity	Rate	Amount
1	Page No - 10, Item No - 01 Dismantling all types of masonry excepting cement concrete plain or reinforced, stacking serviceable materials at site and removing rubbish as directed within a lead of 75 m. a) In ground floor including roof.	Cum	2	0.150	0.100	1.500	0.05		
	Total Qty.	Cum					0.05	447.00	22.35
2	Page No - 10, Item No - 02 Dismantling all types of plain cement concrete works, stacking serviceable materials at site and removing rubbish as directed within a lead of 75m. In ground floor including roof. (a) upto 150 mm. thick	Cum	2	1.500	0.150	0.150	0.07		
	Total Qty.	Cum					0.07	939.00	65.73
3	Page No - 26, Item No - 10 Ordinary Cement concrete (mix 1:1.5:3) with graded stone chips (20 mm nominal size) excluding shuttering and reinforcement if any, in ground floor as per relevant IS codes	Cum	2	1.500	0.150	0.125	0.06		
	Total Qty.	Cum					0.06	5541.66	387.92
4	Page No - 101, Item No - 01 M.S. structural works in columns, beams etc. with simple rolled structural members (e.g. joists, angle, channel sections conforming to IS: 226, IS: 808 & SP (6)- 1964 connected to one another with bracket, gussets, cleats as per design, direction of Engineer-in-charge complete including cutting to requisite shape and length, fabrication with necessary bolting, metal arc welding conforming to IS: 816- 1969 & IS: 1995 using electrodes of approved make and brand conforming to IS:814- 2004, haulage, hoisting and erection all complete. The rate includes the cost of rolled steel section, consumables such as electrodes, gas and hire charge of all tools and plants and labour required for the work including all incidental chages such as electricity charges, labour insurance charges etc. II) For Structural Works in Roof Trusses <i>structural member</i> etc. using joists, channels and angles of specified section weighing less than 22.5 kg/ m	Kg	2	1.500		16.800	50.40		
	Total Qty.in Kg	Kg		1.650		16.800	55.44	5712	
	Total Qty.	MT		1.70			105.84	107.52	
							0.106	60276.00	6389.26
							0.107	72603.00	7768.52

Estimate for Construction of Screening arrangement across the drain at Salgechhia in Ward No - 17, within Tamralipta Municipality

(Rate as per P. W. D. Schedule of Rates effected from 1st November 2017 & 3rd Corriganda w.e.f. 04.06.2018)

Sl. No.	Description of work	Unit	No	Length	Breadth	Height / Depth	Quantity	Rate	Amount
---------	---------------------	------	----	--------	---------	----------------	----------	------	--------

5 Page No - 104, Item No - 12
 M.S. works in framed gratings of window etc. made of round or square bars and frame work or M.S. flats (with the bars securely fixed to the flat bar frame) with or without intermediate flat bar stiffener and fixed with necessary screws etc. complete, as directed.
 In ground floor.

	Kg	1	1.500	1.500	35.000	79.00	88.23	6970.17
Total Qty.	Kg					79.00	66.99	5292.21

9 Page No - 45, Item No - 06-16-21 PWD sheet (Roads)
 Cleaning the exposed reinforcement preferably upto full diameter by wire brush, applying two coats of polymer based rust removing compound left for 24 hours, removing the coating and then applying two (2) coats of polymer modified anti corrosive protective coating formulated to inhibit the corrosion of reinforcement as per manufacturer's specification] [Mode of measurement: The affected surface area of reinforcement shall be considered for payment]

Provide protective anti Corrosive protective coating... - - - ETC

	Sqm	1	1.500	1.500		2.00	506.00	1138.50
Total Qty.	Sqm					2.00	785.00	1570.00
						2.25		13686.19

Add @ 12.00% SGST(6%) & CGST(6%)
 Total Amount
 Add @ 1.00% Labour welfare Cess
 Add @ 3.00% Contengensis
Total

Rs	1962.38	1642.34
Rs	18315.57	15328.53
Rs	183.16	153.29
Rs	549.47	459.86
Rs	19048.26	15941.67

Say Rs. 19048.00 15942.00
(Rupees nineteen thousand forty eight) only

130000
 10/12/19
K. PANJA
 Sub-Assistant Engineer
 Tamralipta Municipality

[Signature]
 Chairman
 Tamralipta Municipality

May be vetted
[Signature]
 12/12/19
 Junior Engineer,
 East Medinipur Division
 (M. E. Dte.) Tamruk
 Govt. of West Bengal

May be vetted.
[Signature]
 12/12/19
 Assistant Engineer,
 East Medinipur Division
 (M. E. Dte.) Tamruk
 Govt. of West Bengal

Vetted
[Signature]
 12/12/19
 Executive Engineer,
 East Medinipur Division
 (M. E. Dte.) Tamruk
 Govt. of West Bengal

CROSS SECTION OF DRAIN - 6 AT SALGECHHIA IN WRAD NO - 17 WITHIN TAMRALIPTA MUNICIPALITY

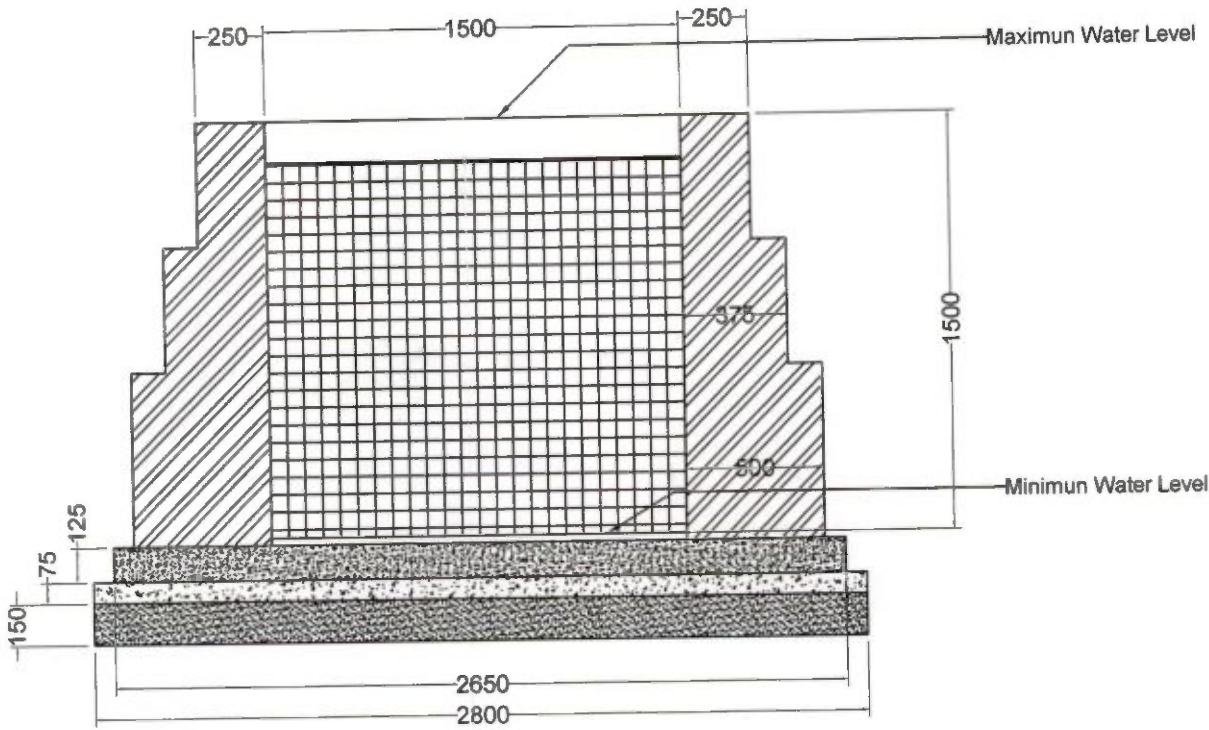

SECTIONAL PLAN OF DRAIN (AT CHAINAGE 75M FROM OUT FALL POINT)

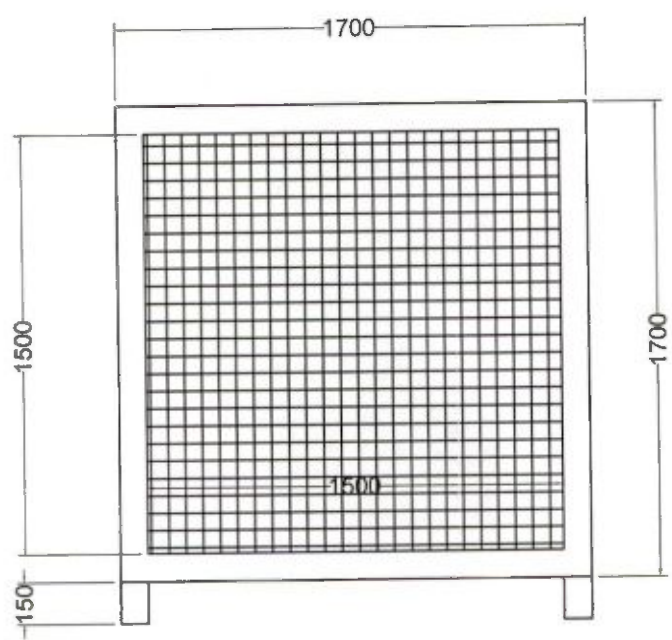

SECTIONAL PLAN OF GRATING

Signature
12/12/19

Assistant Engineer,
East Medinipur Division
(M.E. Dte.) Tamluk
Govt. of West Bengal

Vetted

Signature
12/12/19

Executive Engineer,
East Medinipur Division
(M.E. Dte.) Tamluk
Govt. of West Bengal

Signature
10/12/19

K. PANJA
Sub-Assistant Engineer
Tamralipta Municipality

TAMRALIPTA MUNICIPALITY
TAMLUK :: PURBA MEDINIPUR
DETAIL MEASUREMENTS AND CALCULATIONS

Detailed Estimate No. :-
 Name of works :-

for the year 200 to 200

Estimate for Construction of Screening arrangement across the drain at Daharpur & Dharinda in Ward No - 16 & 20, within Tamralipta Municipality
 (Rate as per P. W. D. Schedule of Rates effected from 1st November 2017 & 3rd Corrigananda w.e.f. 04.06.2018)

Sl. No.	Description of work	Unit	No	Length	Breadth	Height / Depth	Quantity	Rate	Amount
1	Page No - 01, Item No - 02 Earth work in excavation of foundation trenches drain, in all sorts of soil (including mixed soil spreading or stacking the spoils within a lead of 75m. as directed. The item includes and ramming the Bottombailing out water as required complete. a) Depth of excavation not exceeding 1500mm.	Cum	2	1.200 ^{1.05}	1.200 ^{1.05}	0.650	1.87	143	
		Cum	2	1.200	1.200	0.900	2.59	198	
	Total Qty.	Cum		1.05	1.05		4.46	119.27	406.71
							3.41		531.94
2	Page No - 02, Item No - 04 Filling in foundation or plinth by silver sand in layers not exceeding 150mm. As directed and consolidating same by thorough saturation with water ramming complete, including the cost of supply of sand. (Payment to be made on measurement of finished quantity). a) Do-by fine sand	Cum	2	1.200 ^{1.05}	1.200 ^{1.05}	0.075	0.22		86.96
	Total Qty.	Cum					0.22	543.51	119.57
3	Page No - 23, Item No - 01 Cement concrete with graded Jhama Khoa (30mm size) excluding shuttering. In ground floor and foundation. (a) 6:3:1 proportion	Cum	2	1.200 ^{1.05}	1.200 ^{1.05}	0.075	0.22		689.10
	Total Qty.	Cum					0.22	4306.87	976.58
4	Page No - 26, Item No - 10 Ordinary Cement concrete (mix 1:1.5:3) with graded stone chips (20 mm nominal size) excluding shuttering and reinforcement if any, in ground floor as per relevant IS codes	Cum	2	1.050	1.050	0.300	0.66		
		Cum	2	0.700	0.700	0.250	0.25		
	Total Qty.	Cum					0.91	5541.66	5042.91
								5777.32	5257.36

Estimate for Construction of Screening arrangement across the drain at Daharpur & Dharinda in Ward No - 16 & 20, within Tamralipta Municipality

(As per P. W. D. Schedule of Rates effected from 1st November 2017 & 3rd Corriganda w.e.f. 04.06.2018)

Sl. No.	Description of work	Unit	No	Length	Breadth	Height / Depth	Quantity	Rate	Amount
---------	---------------------	------	----	--------	---------	----------------	----------	------	--------

5 Page No - 42 , Item No - 36
 Hire and labour charges for shuttering with centering and necessary staging upto 4m. using approved stout props and thick hard wood planks of approved thickness with required bracing for concrete slabs, beams, columns, lintels curved or straight including fitting, fixing and striking out after completion of works. (up to roof of ground floor)
 (When the height of a particular floor is more than 4m. the equivalent floor ht. Shall be taken as 4m. and extra for works beyond the initial 4m. ht. Shall be allowed under 12(e) for every 4m. or part thereof.)
 a) 25 mm to 30 mm thick wooden shuttering as per dicission direction of engineer in charge.
 i) In foundation & ground floor.

Sqm	8	1.050	0.300	2.52		
Sqm	8	0.700	0.250	1.40		
Total Qty.	Sqm			3.92	205.00	803.60

6 Page No - 43 , Item No - 40
 Reinforcement for reinforced concrete work in the all sorts of structures including distribution bars, stirrups, binders etc. including supply of rods, initial straightening and removal of loose rust (if necessary)cutting to requisite length, hooking & bending to correct shape, placing in proper position and binding with 16 gauge black annealed wire at every intersection, complete as per drawing and direction.
 (a) For works in foundation, basement and upto roof of ground floor / upto 4 m.
 (i) Tor steel / Mild steel.

;1% of Concrete Qty.	MT			0.071	48785.87	3463.80
Total Qty.	MT			0.071	52938.20	3758.61

7 Page No - 101, Item No - 01
 M.S. structural works in columns, beams etc. with simple rolled structural members (e.g. joists, angle, channel sections conforming to IS: 226, IS: 808 & SP (6)- 1964 connected to one another with bracket, gussets, cleats as per design, direction of Engineer-incharge complete including cutting to requisite shape and length, fabrication with necessary bolting, metal arc welding conforming to IS: 816- 1969 & IS: 1995 using electrodes of approved make and brand conforming to IS:814- 2004, haulage, hoisting and erection all complete. The rate includes the cost of rolled steel section, consumables such as electrodes, gas and hire charge of all tools and plants and labour required for the work including all incidental chages such as electricity charges, labour insurance charges etc.
 II) For Structural Works in Roof Trusses etc. using joists, channels and angles of specified section weighing less than 22.5 kg/ m

	Kg	2	3.000	16.800	100.80	
	Kg	1	3.000	16.800	50.40	
	Kg	1	5.920	16.800	99.46	
	Kg	2	2.655	16.800	89.21	
Total Qty.in Kg	Kg			339.87	72603.00	24685.02
Total Qty.	MT			0.340	60276.00	20493.84

Estimate for Construction of Screening arrangement across the drain at Daharpur & Dharinda in Ward No - 16 & 20, within Tamralipta Municipality

(Note as per P. W. D. Schedule of Rates effected from 1st November 2017 & 3rd Corriganda w.e.f. 04.06.2018)

Sl. No.	Description of work	Unit	No	Length	Breadth	Height / Depth	Quantity	Rate	Amount
---------	---------------------	------	----	--------	---------	----------------	----------	------	--------

8	Page No - 104, Item No - 12 M.S. works in framed gratings of window etc. made of round or square bars and frame work or M.S. flats (with the bars securely fixed to the flat bar frame) with or without intermediate flat bar stiffener and fixed with necessary screws etc. complete, as directed. In ground floor.	Kg	1	3.000	3.000	35.000	315.00		
	4x0.5	Kg	2 x 1/2	1.460	2.655	35.000	271.00	135.47	
	Total Qty.	Kg					586.00	66.99	39256.14

9	Page No - 45, Item No - 06 16-21 PWD (Road) sche. Cleaning the exposed reinforcement preferably upto full diameter by wire brush, applying two coats of polymer based rust removing compound left for 24 hours, removing the coating and then applying two (2) coats of polymer modified anti corrosive protective coating formulated to inhibit the corrosion of reinforcement as per manufacturer's specification] [Mode of measurement: The affected surface area of reinforcement shall be considered for payment]	Sqm	1	3.000	3.000		9.00		
		Sqm	2 x 1/2	1.460	2.655		8.00	3.87	
	Total Qty.	Sqm					17.00	785.90	13345.00

*providing anti corrosive protective coating ---
--- EIC*

							12.87		
	Add @ 12.00% SGST(6%) & CGST(6%)							506.00	6512.22
	Total Amount								84542.64
	Add @ 1.00% Labour welfare Cess								81452.93
	Add @ 3.00% Contengensis								10145.12
	Total								94687.76
									912.27
									946.88
									2736.82
									2840.63
									98475.27

12/12/19
K. PANJA
Sub-Assistant Engineer
Tamralipta Municipality

dy
Chairman
Tamralipta Municipality

Say **Rs. 94876.00 98475.00**
Rupus ninety four thousand eight hundred seventy six/only

Vetted
12/12/19
Executive Engineer
East Medinipur Division
(M. E. Dte.) Tamluk
Govt. of West Bengal

May be vetted
12/12/19
Junior Engineer
East Medinipur Division
(M. E. Dte.) Tamluk
Govt. of West Bengal

May be vetted.
12/12/19
Assistant Engineer
East Medinipur Division
(M. E. Dte.) Tamluk
Govt. of West Bengal

CROSS SECTION OF DRAIN - 7 AT DAHARPUR & DHARINDA IN WRAD NO - 16 & 20 WITHIN TAMRALIPTA MUNICIPALITY

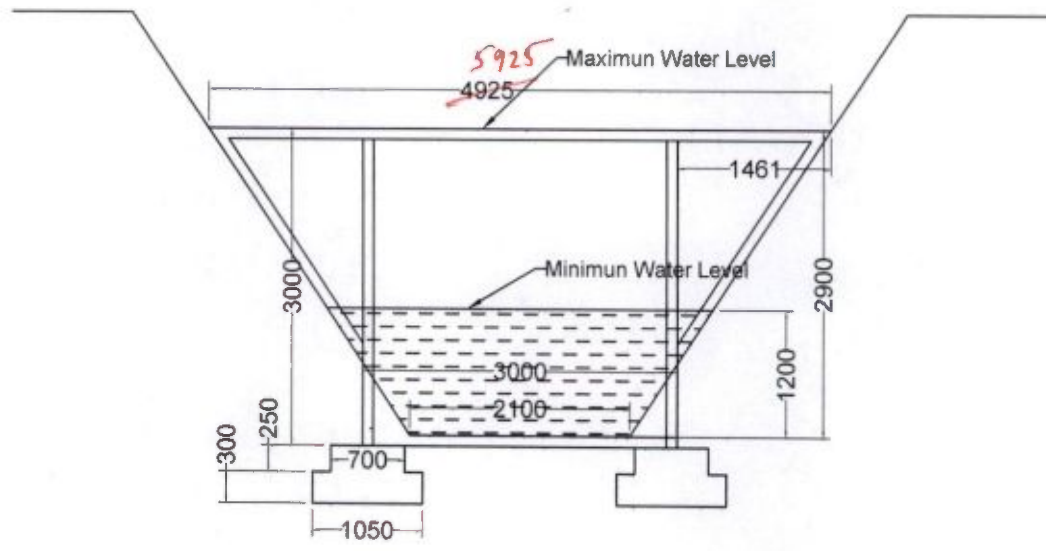

SECTIONAL PLAN OF DRAIN
(AT CHAINAGE 75M FROM OUT FALL POINT)

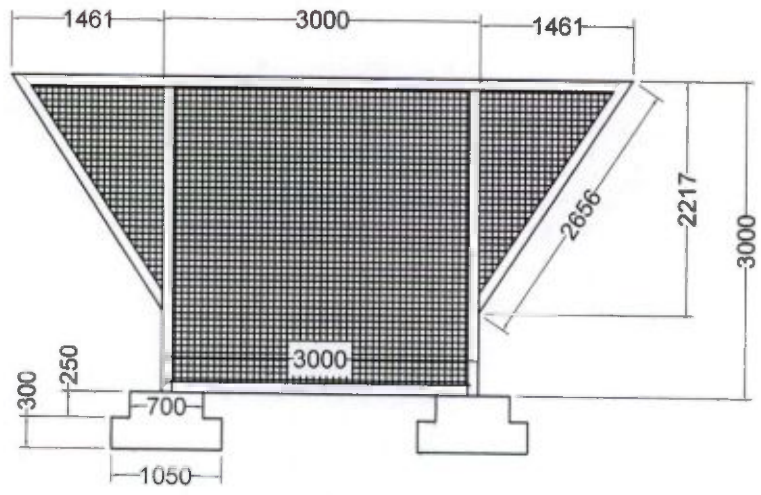

SECTIONAL PLAN OF GRATING

[Signature]
12/12/19

Assistant Engineer,
East Medinipur Division
(M.E. Dte.) Tamruk
Govt. of West Bengal

Vetted

[Signature]
12/12/19

Executive Engineer,
East Medinipur Division
(M.E. Dte.) Tamruk
Govt. of West Bengal

[Signature]
10/12/19

K. PANJA
Sub-Assistant Engineer
Tamralipta Municipality

TAMRALIPTA MUNICIPALITY
TAMLUK :: PURBA MEDINIPUR
DETAIL MEASUREMENTS AND CALCULATIONS

Detailed Estimate No. :-
Name of works :-

for the year 200 to 200

Estimate for Construction of Screening arrangement across the drain at Sankarara in Ward No - 17, within Tamralipta Municipality

(Rate as per P. W. D. Schedule of Rates effected from 1st November 2017 & 3rd Corriganda w.e.f. 04.06.2018)

Sl. No.	Description of work	Unit	No	Length	Breadth	Height / Depth	Quantity	Rate	Amount
1	Page No - 10, Item No - 01 Dismantling all types of masonry excepting cement concrete plain or reinforced, stacking serviceable materials at site and removing rubbish as directed within a lead of 75 m. a) In ground floor including roof.	Cum	2	0.150	0.100	1.500	0.05		
	Total Qty.	Cum					0.05	447.00	22.35
2	Page No - 10, Item No - 02 Dismantling all types of plain cement concrete works, stacking serviceable materials at site and removing rubbish as directed within a lead of 75m. In ground floor including roof. (a) upto 150 mm. thick	Cum	2	1.500	0.150	0.150	0.07		
	Total Qty.	Cum					0.07	939.00	65.73
3	Page No - 26, Item No - 10 Ordinary Cement concrete (mix 1:1.5:3) with graded stone chips (20 mm nominal size) excluding shuttering and reinforcement if any, in ground floor as per relevant IS codes	Cum	2	1.500	0.150	0.125	0.06		
	Total Qty.	Cum					0.06	5541.61	387.92
4	Page No - 101, Item No - 01 M.S. structural works in columns, beams etc. with simple rolled structural members (e.g. joists, angle, channel sections conforming to IS: 226, IS: 808 & SP (6)- 1964 connected to one another with bracket, gussets, cleats as per design, direction of Engineer-in-charge complete including cutting to requisite shape and length, fabrication with necessary bolting, metal arc welding conforming to IS: 816- 1969 & IS: 1995 using electrodes of approved make and brand conforming to IS:814- 2004, haulage, hoisting and erection all complete. The rate includes the cost of rolled steel section, consumables such as electrodes, gas and hire charge of all tools and plants and labour required for the work including all incidental chages such as electricity charges, labour insurance charges etc. II) For Structural Works in Roof Trusses etc. using joists, channels and angles of specified section weighing less than 22.5 kg/ m	Kg	2	1.500		16.800	50.40		
	Total Qty.in Kg	Kg		1.650		16.800	55.44	57.12	
	Total Qty.	MT		1.72			105.84	107.52	3463.80
							0.106	60276.00	6389.26
							0407	72603.00	

Estimate for Construction of Screening arrangement across the drain at Sankarara in Ward No - 17, within Tamralipta Municipality

(Rate as per P. W. D. Schedule of Rates effected from 1st November 2017 & 3rd Corriganda w.e.f. 04.06.2018)

Sl. No.	Description of work	Unit	No	Length	Breadth	Height / Depth	Quantity	Rate	Amount
5	Page No - 104, Item No - 12 M.S. works in framed gratings of window etc.made of round or square bars and frame work or M.S. flats (with the bars securely fixed to the flat bar frame) with or without intermediate flat bar stiffener and fixed with necessary screws etc. complete, as directed. In ground floor.	Kg	1	1.500	1.500	35.000	79.00		
	Total Qty.	Kg					79.00	88.23	6970.17
9	Page No - 45, Item No - 06 1621 PWD ROAD SCHE. Cleaning the exposed reinforcement preferably upto full diameter by wire brush, applying two coats of polymer based rust removing compound left for 24 hours, removing the coating and then applying two (2) coats of polymer modified anti corrosive protective coating formulated to inhibit the corrosion of reinforcement as per manufacturer's specification] [Mode of measurement: The affected surface area of reinforcement shall be considered for payment]	Sqm	1	1.500	1.500		2.00	506.00	1138.50
	Total Qty.	Sqm					2.00	785.00	1570.00
		Total					2.25		13686.19
	Add @ 12.00% SGST(6%) & CGST(6%)						Rs	1962.38	1642.34
	Total Amount						Rs	18315.57	15328.53
	Add @ 1.00% Labour welfare Cess						Rs	183.16	153.29
	Add @ 3.00% Contengensis						Rs	549.47	459.86
	Total						Rs	19048.20	15941.67
							Say	Rs. 19048.00	15942.00

Providing anticorrosive protective coating --- BIC

(Rupees nineteen thousand forty eight) only

K. PANJA
Sub-Assistant Engineer
Tamralipta Municipality

Chairman
Tamralipta Municipality

May be vetted
12/12/19
Junior Engineer,
East Medinipur Division
(M.E. Dte.) Tamluk
Govt. of West Bengal

May be vetted.
12/12/19
Assistant Engineer,
East Medinipur Division
(M.E. Dte.) Tamluk
Govt. of West Bengal

Vetted
12/12/19
Executive Engineer,
East Medinipur Division
(M.E. Dte.) Tamluk
Govt. of West Bengal

CROSS SECTION OF DRAIN - 10 AT SANKARARA IN WRAD NO - 17 WITHIN TAMRALIPTA MUNICIPALITY

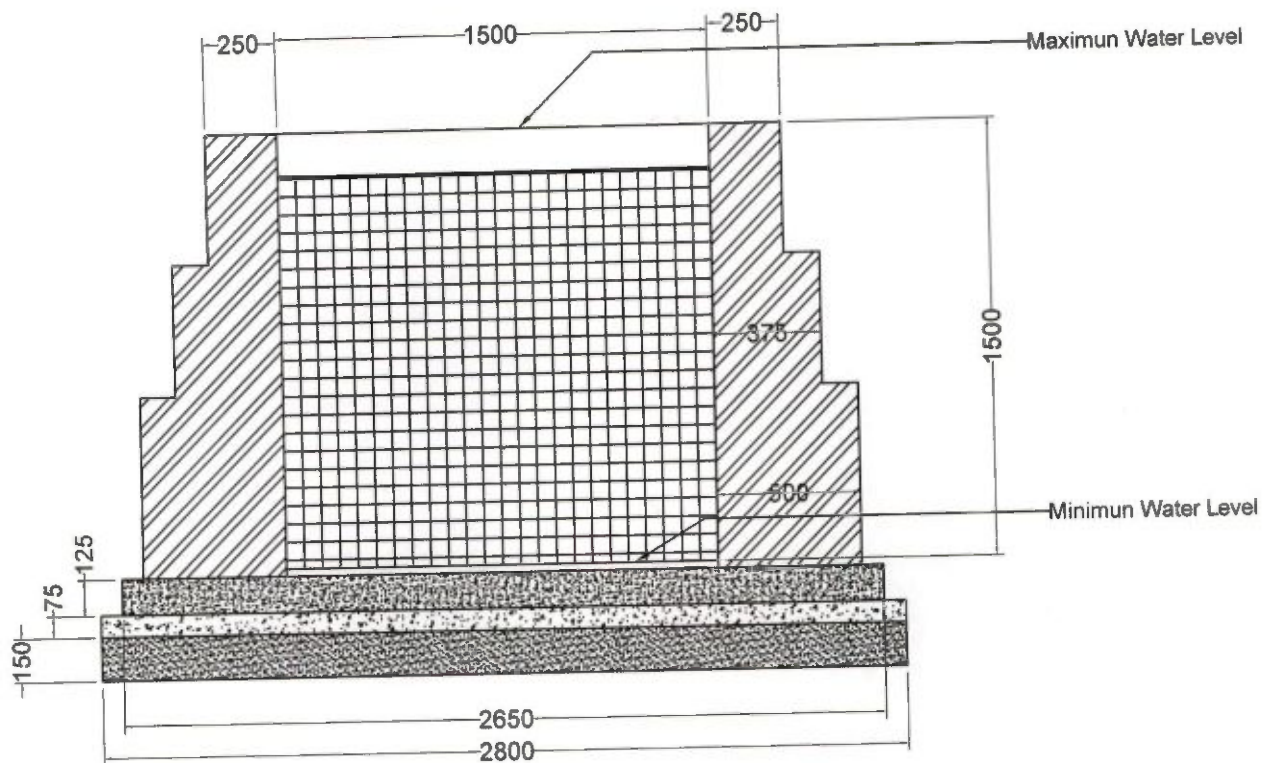

SECTIONAL PLAN OF DRAIN (AT CHAINAGE 75M FROM OUT FALL POINT)

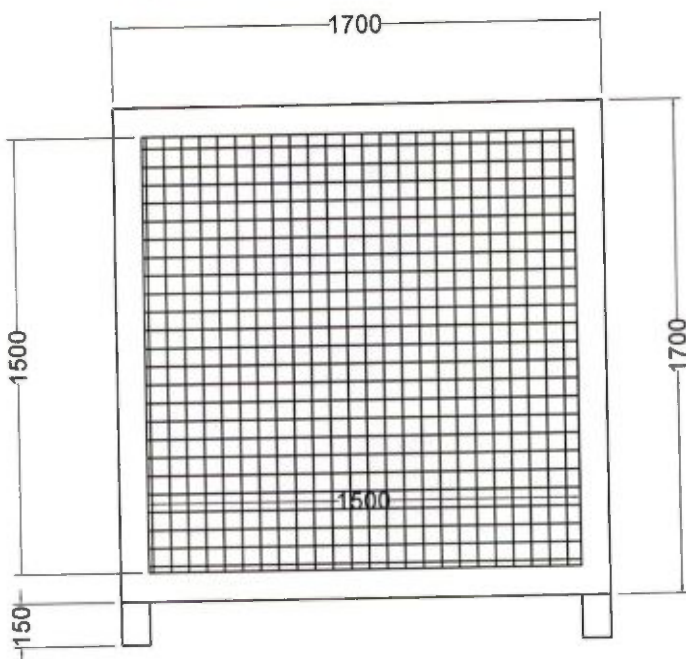

SECTIONAL PLAN OF GRATING

Signature
12/2/19

Assistant Engineer,
East Medinipur Division
(M.E. Dte.) Tamluk
Govt. of West Bengal

Vetted

Signature
12/2/19
Executive Engineer,
East Medinipur Division
(M.E. Dte.) Tamluk
Govt. of West Bengal

Signature
10.12.19
K. PANJA

Sub-Assistant Engineer
Tamralipta Municipality

TAMRALIPTA MUNICIPALITY
TAMLUK :: PURBA MEDINIPUR
DETAIL MEASUREMENTS AND CALCULATIONS

Detailed Estimate No. :-
Name of works :-

for the year 200 to 200

**Estimate for Construction of Screening arrangement across the drain at D. C. Sankarara in
Ward No - 15, 18 & 19, within Tamralipta Municipality**

(Rate as per P. W. D. Schedule of Rates effected from 1st November 2017 & 3rd Corriganada w.e.f. 04.06.2018)

Sl. No.	Description of work	Unit	No	Length	Breadth	Height / Depth	Quantity	Rate	Amount
1	Page No - 01, Item No - 02 Earth work in excavation of foundation trenches drain, in all sorts of soil (including mixed soil spreading or stacking the spoils within a lead of 75m. as directed. The item includes and ramming the Bottombailing out water as required complete. a) Depth of excavation not exceeding 1500mm.	Cum	4	1.200	1.200	0.650	2.87 3.74		
		Cum	4	1.200	1.200	0.900	5.18	3.97	
	Total Qty.	Cum		1.05	1.05		8.92	119.27	815.81 1063.89
2	Page No - 02, Item No - 04 Filling in foundation or plinth by silver sand in layers not exceeding 150mm. As directed and consolidating same by thorough saturation with water ramming complete, including the cost of supply of sand. (Payment to be made on measurement of finished quantity). a) Do-by fine sand	Cum	4	1.200	1.200	0.075	0.43		
	Total Qty.	Cum					0.43	543.51	179.26 233.71
3	Page No - 23, Item No - 01 Cement concrete with graded Jhama Khoa (30mm size) excluding shuttering. In ground floor and foundation. (a) 6:3:1 proportion	Cum	4	1.200	1.200	0.075	0.43		
	Total Qty.	Cum					0.43	436.87	1421.27
4	Page No - 26, Item No - 10 Ordinary Cement concrete (mix 1:1.5:3) with graded stone chips (20 mm nominal size) excluding shuttering and reinforcement if any, in ground floor as per relevant IS codes	Cum	4	1.050	1.050	0.300	1.32		
		Cum	4	0.700	0.700	0.250	0.49		
	Total Qty.	Cum					1.81	5541.66 5777.32	10030.40 10456.95

**Estimate for Construction of Screening arrangement across the drain at D. C. Sankarara in
Ward No - 15, 18 & 19, within Tamralipta Municipality**

(As per P. W. D. Schedule of Rates effected from 1st November 2017 & 3rd Corriganda w.e.f. 04.06.2018)

Sl. No.	Description of work	Unit	No	Length	Breadth	Height / Depth	Quantity	Rate	Amount
---------	---------------------	------	----	--------	---------	----------------	----------	------	--------

5 Page No - 42 , Item No - 36

Hire and labour charges for shuttering with centering and necessary staging upto 4m. using approved stout props and thick hard wood planks of approved thickness with required bracing for concrete slabs, beams, columns, lintels curved or straight including fitting, fixing and striking out after completion of works. (up to roof of ground floor)

(When the height of a particular floor is more than 4m. the equivalent floor ht. Shall be taken as 4m. and extra for works beyond the initial 4m. ht. Shall be allowed under 12(e) for every 4m. or part thereof.)

a) 25 mm to 30 mm thick wooden shuttering as per dicission direction of engineer in charge.

i) In foundation & ground floor.

Sqm	16	1.050	0.300	5.04		
Sqm	16	0.700	0.250	2.80		
Total Qty.	Sqm			7.84	205.00	1607.20

6 Page No - 43 , Item No - 40

Reinforcement for reinforced concrete work in the all sorts of structures including distribution bars, stirrups, binders etc. including supply of rods, initial straightening and removal of loose rust (if necessary)cutting to requisite length, hooking & bending to correct shape, placing in proper position and binding with 16 gauge black annealed wire at every intersection, complete as per drawing and direction.

(a) For works in foundation, basement and upto roof of ground floor / upto 4 m.

(i) Tor steel / Mild steel.

;1% of Concrete Qty.	MT			0.142		
Total Qty.	MT			0.142	48785.87	6927.59
					52938.20	7517.22

7 Page No - 101, Item No - 01

M.S. structural works in columns, beams etc. with simple rolled structural members (e.g. joists, angle, channel sections conforming to IS: 226, IS: 808 & SP (6)- 1964 connected to one another with bracket, gussets, cleats as per design, direction of Engineer-in-charge complete including cutting to requisite shape and length, fabrication with necessary bolting, metal arc welding conforming to IS: 816- 1969 & IS: 1995 using electrodes of approved make and brand conforming to IS:814- 2004, haulage, hoisting and erection all complete. The rate includes the cost of rolled steel section, consumables such as electrodes, gas and hire charge of all tools and plants and labour required for the work including all incidental chages such as electricity charges, labour insurance charges etc.

II) For Structural Works in Roof ~~trusses etc. using joists, channels and angles~~ ^{structural members} of specified section weighing less than 22.5 kg/ m

	Kg	4	3.000	16.800	201.60	
	Kg	2	3.000	16.800	100.80	
	Kg	2	5.920 4.925	16.800	198.91	165.48
	Kg	4	2.655	16.800	178.42	
Total Qty.in Kg	Kg				679.73	64630
Total Qty.	MT				0.680	60276.00
					0.646	72603.00
						40987.68
						46901.54

Estimate for Construction of Screening arrangement across the drain at D. C. Sankarara in Ward No - 15, 18 & 19, within Tamralipta Municipality

(As per P. W. D. Schedule of Rates effected from 1st November 2017 & 3rd Corriganda w.e.f. 04.06.2018)

Sl. No.	Description of work	Unit	No	Length	Breadth	Height / Depth	Quantity	Rate	Amount
---------	---------------------	------	----	--------	---------	----------------	----------	------	--------

8 Page No - 104, Item No - 12

M.S. works in framed gratings of window etc. made of round or square bars and frame work or M.S. flats (with the bars securely fixed to the flat bar frame) with or without intermediate flat bar stiffener and fixed with necessary screws etc. complete, as directed.
In ground floor.

		Kg	2	3.000	3.000	35.000	630.00		
4x0.5		Kg	4 $\times \frac{1}{2}$	1.460	2.655	35.000	543.00	271.34	
Total Qty.		Kg					1173.00	66.99	78579.27

9 Page No - ~~45~~ 16-21 Item No - 06 PWD Roads sch

Cleaning the exposed reinforcement preferably upto full diameter by wire brush, applying two coats of polymer based rust removing compound left for 24 hours, removing the coating and then applying two (2) coats of polymer modified anti corrosive protective coating formulated to inhibit the corrosion of reinforcement as per manufacturer's specification] [Mode of measurement: The affected surface area of reinforcement shall be considered for payment]

Providing anti corrosive protective coating --- --- EIC

		Sqm	2	3.000	3.000		18.00		
		Sqm	4 $\times \frac{1}{2}$	1.460	2.655		16.00	7.75	
Total Qty.		Sqm					34.00	506.00	13029.50
							25.75		

Add @ 12.00% SGST(6%) & CGST(6%)

Rs 19252.55 20285.36

Total Amount

Rs 179690.45 189330.05

Add @ 1.00% Labour welfare Cess

Rs 1796.90 1893.30

Add @ 3.00% Contengensis

Rs 5390.71 5679.90

Total

Rs 186878.07 196903.25

Say Rs. 186878.07 196903.00

(Rupees one lakh eighty six thousand eight hundred seventy eight) only

K. PANJA
Sub-Assistant Engineer
Tamralipta Municipality

Chairman
Tamralipta Municipality

Vetted

May be vetted
12/12/19
Junior Engineer,
East Medinipur Division
(M.E. Dte.) Tamluk
Govt. of West Bengal

May be vetted.
12/12/19
Assistant Engineer,
East Medinipur Division
(M.E. Dte.) Tamluk
Govt. of West Bengal

Executive Engineer,
East Medinipur Division
(M.E. Dte.) Tamluk
Govt. of West Bengal

CROSS SECTION OF DRAIN - 5 AT D. C. SANKARARA IN WRAD NO - 15, 18 & 19 WITHIN TAMRALIPTA MUNICIPALITY (2 Nos)

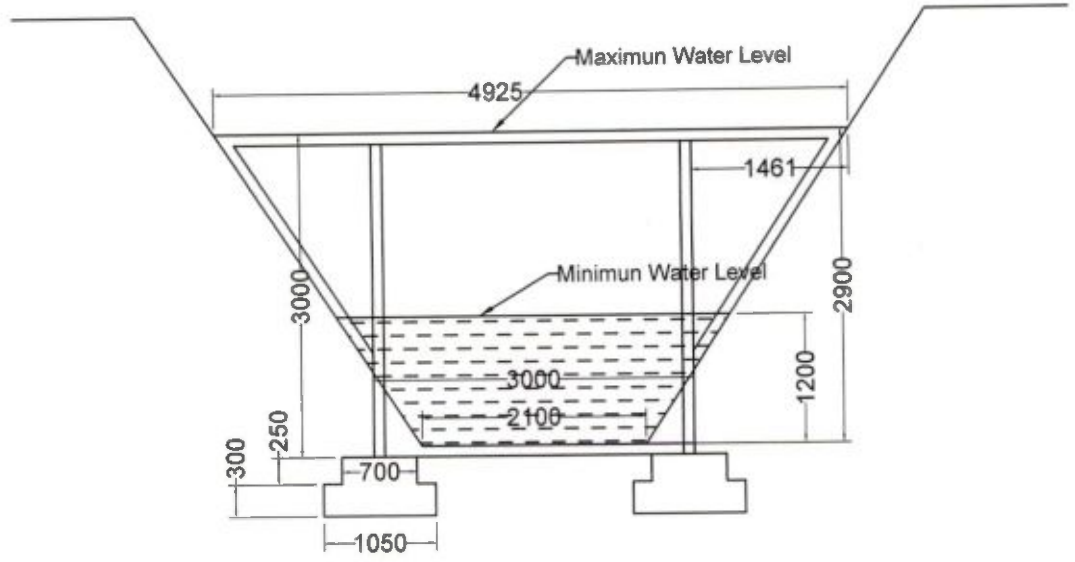

SECTIONAL PLAN OF DRAIN
(AT CHAINAGE 75M FROM OUT FALL POINT)

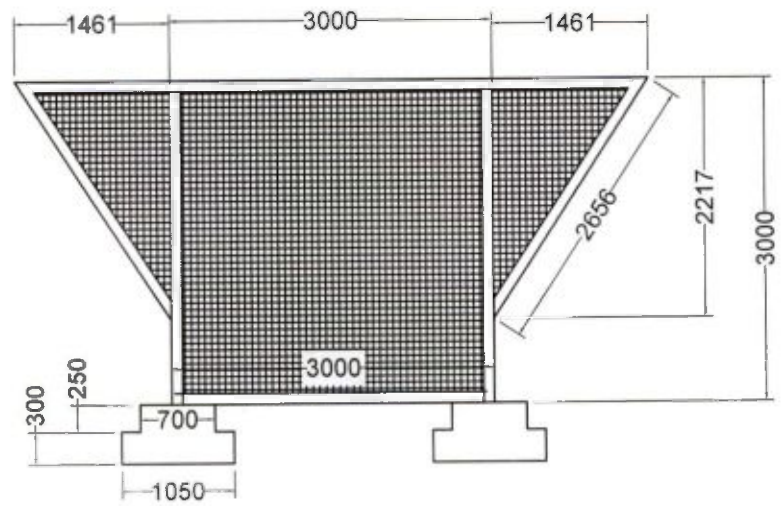

SECTIONAL PLAN OF GRATING

[Signature] 12/12/19
 Assistant Engineer,
 East Medinipur Division
 (M.E. Dte.) Tamruk
 Govt. of West Bengal

Vetted
[Signature] 12/12/19
 Executive Engineer,
 East Medinipur Division
 (M.E. Dte.) Tamruk
 Govt. of West Bengal

[Signature]
K. PANJA
 Sub-Assistant Engineer
 Tamralipta Municipality

TAMRALIPTA MUNICIPALITY
TAMLUK :: PURBA MEDINIPUR
DETAIL MEASUREMENTS AND CALCULATIONS

Detailed Estimate No. :-

for the year 200 to 200

Name of works :-

Estimate for Construction of Screening arrangement across the drain at Kapasbaria in Ward No - 19, within Tamralipta Municipality

(Rate as per P. W. D. Schedule of Rates effected from 1st November 2017 & 3rd Corriganda w.e.f. 04.06.2018)

Sl. No.	Description of work	Unit	No	Length	Breadth	Height / Depth	Quantity	Rate	Amount
1	Page No - 01, Item No - 02 Earth work in excavation of foundation trenches drain, in all sorts of soil (including mixed soil spreading or stacking the spoils within a lead of 75m. as directed. The item includes and ramming the Bottombailing out water as required complete. a) Depth of excavation not exceeding 1500mm.	Cum	2	1.200 ^{1.05}	1.200 ^{1.05}	0.650	1.871.43		
		Cum	2	1.200	1.200	0.900	2.59	1.98	406.71
	Total Qty.	Cum		1.05	1.05		4.46	119.27	531.94
2	Page No - 02, Item No - 04 Filling in foundation or plinth by silver sand in layers not exceeding 150mm. As directed and consolidating same by thorough saturation with water ramming complete, including the cost of supply of sand. (Payment to be made on measurement of finished quantity). a) Do-by fine sand	Cum	2	1.200	1.200	0.075	0.22 ^{0.16}		86.96
	Total Qty.	Cum		1.05	1.05		0.22	543.51	119.57
3	Page No - 23, Item No - 01 Cement concrete with graded Jhama Khoa (30mm size) excluding shuttering. In ground floor and foundation. (a) 6:3:1 proportion	Cum	2	1.200	1.200	0.075	0.22 ^{0.16}		689.10
	Total Qty.	Cum		1.05	1.05		0.22	4306.10	976.58
4	Page No - 26, Item No - 10 Ordinary Cement concrete (mix 1:1.5:3) with graded stone chips (20 mm nominal size) excluding shuttering and reinforcement if any, in ground floor as per relevant IS codes	Cum	2	1.050	1.050	0.300	0.66		
		Cum	2	0.700	0.700	0.250	0.25	5541.66	5042.91
	Total Qty.	Cum					0.91	5777.32	5257.36

Estimate for Construction of Screening arrangement across the drain at Kapasbaria in Ward No - 19, within Tamralipta Municipality

(Rate as per P. W. D. Schedule of Rates effected from 1st November 2017 & 3rd Corriganda w.e.f. 04.06.2018)

Sl. No.	Description of work	Unit	No	Length	Breadth	Height / Depth	Quantity	Rate	Amount
5	Page No - 42 , Item No - 36 Hire and labour charges for shuttering with centering and necessary staging upto 4m. using approved stout props and thick hard wood planks of approved thickness with required bracing for concrete slabs, beams, columns, lintels curved or straight including fitting, fixing and striking out after completion of works. (up to roof of ground floor) (When the height of a particular floor is more than 4m. the equivalent floor ht. Shall be taken as 4m. and extra for works beyod the initial 4m. ht. Shall be allowed under 12(e) for every 4m. or part thereof.) a) 25 mm to 30 mm thick wooden shuttering as per dicission direction of engineer in charge. i) In foundation & ground floor.	Sqm	8	1.050		0.300	2.52		
		Sqm	8	0.700		0.250	1.40		
	Total Qty.	Sqm					3.92	205.00	803.60
6	Page No - 43 , Item No - 40 Reinforcement for reinforced concrete work in the all sorts of structures including distribution bars, stirrups, binders etc. including supply of rods, initial straightening and removal of loose rust (if necessary)cutting to requisite length, hooking & bending to correct shape, placing in proper position and binding with 16 gauge black annealed wire at every intersection, complete as per drawing and direction. (a) For works in foundation, basement and upto roof of ground floor / upto 4 m. (i) Tor steel / Mild steel.								
	;1% of Concrete Qty.	MT					0.071		48785.87 3463.80
	Total Qty.	MT					0.071	52938.20	3758.61
7	Page No - 101, Item No - 01 M.S. structural works in columns, beams etc. with simple rolled structural members (e.g. joists, angle, channel sections conforming to IS: 226, IS: 808 & SP (6)- 1964 connected to one another with bracket, gussets, cleats as per design, direction of Engineer-in-charge complete including cutting to requisite shape and length, fabrication with necessary bolting, metal arc welding conforming to IS: 816- 1969 & IS: 1995 using electrodes of approved make and brand conforming to IS:814- 2004, haulage, hoisting and erection all complete. The rate includes the cost of rolled steel section, consumables such as electrodes, gas and hire charge of all tools and plants and labour required for the work including all incidental chages such as electricity charges, labour insurance charges etc. II) For Structural Works in Roof Trusses etc. using joists, channels and angles of specified section weighing less than 22.5 kg/ m								
		Kg	2	3.000		16.800	100.80		
		Kg	1	3.000		16.800	50.40		
		Kg	1	5.920		16.800	99.46		
		Kg	2	2.655		16.800	89.21		
	Total Qty.in Kg	Kg					339.87		72603.00 24685.02
	Total Qty.	MT					0.340	60276.00	20493.84

Estimate for Construction of Screening arrangement across the drain at Kapasbaria in Ward No - 19, within Tamralipta Municipality

(Rate as per P. W. D. Schedule of Rates effected from 1st November 2017 & 3rd Corriganda w.e.f. 04.06.2018)

SI. No.	Description of work	Unit	No	Length	Breadth	Height / Depth	Quantity	Rate	Amount
---------	---------------------	------	----	--------	---------	----------------	----------	------	--------

8 Page No - 104, Item No - 12
 M.S. works in framed gratings of window etc.made of round or square bars and frame work or M.S. flats (with the bars securely fixed to the flat bar frame) with or without intermediate flat bar stiffener and fixed with necessary screws etc. complete, as directed.
 In ground floor.

		Kg	1	3.000	3.000	35.000	315.00		
	4x0.5	Kg	2 $\times \frac{1}{2}$	1.460	2.655	35.000	271.00	135.67	
	Total Qty.	Kg					586.00	66.99	39762.61

9 Page No - 45, Item No - 08-16-21 PWD Roads etc.
 Cleaning the exposed reinforcement preferably upto full diameter by wire brush, applying two coats of polymer based rust removing compound left for 24 hours, removing the coating and then applying two (2) coats of polymer modified anti corrosive protective coating formulated to inhibit the corrosion of reinforcement as per manufacturer's specification] [Mode of measurement: The affected surface area of reinforcement shall be considered for payment]

Providing anti-corrosive protective coating --- ---BIC

		Sqm	1	3.000	3.000		9.00		
		Sqm	2 $\times \frac{1}{2}$	1.460	2.655		8.00	387	
	Total Qty.	Sqm					17.00	506.00	6512.22

Total

Rs. 84542.64
 81452.93

Add @ 12.00% SGST(6%) & CGST(6%)

Rs 9474.31 10145.12

Total Amount

Rs 91227.28 94687.76

Add @ 1.00% Labour welfare Cess

Rs 912.27 946.88

Add @ 3.00% Contengensis

Rs 2736.82 2840.63

Total

Rs 94876.37 98475.27

Say

Rs. 94876.00 98475.00

(Rupees ninety four thousand eight hundred seventy six) only

[Signature]
 K. PANJA
 Sub-Assistant Engineer
 Tamralipta Municipality

[Signature]
 Chairman
 Tamralipta Municipality

May be vetted
[Signature]
 12/12/19
 Junior Engineer,
 East Medinipur Division
 (M.E. Dte.) Tamluk
 Govt. of West Bengal

May be vetted.
[Signature]
 12/12/19
 Assistant Engineer,
 East Medinipur Division
 (M.E. Dte.) Tamluk
 Govt. of West Bengal

Vetted

[Signature]
 12/12/19
 Executive Engineer,
 East Medinipur Division
 (M.E. Dte.) Tamluk
 Govt. of West Bengal

● ROSS SECTION OF DRAIN - 8 AT KAPASBARIA IN WRAD NO - 19 WITHIN TAMRALIPTA MUNICIPALITY

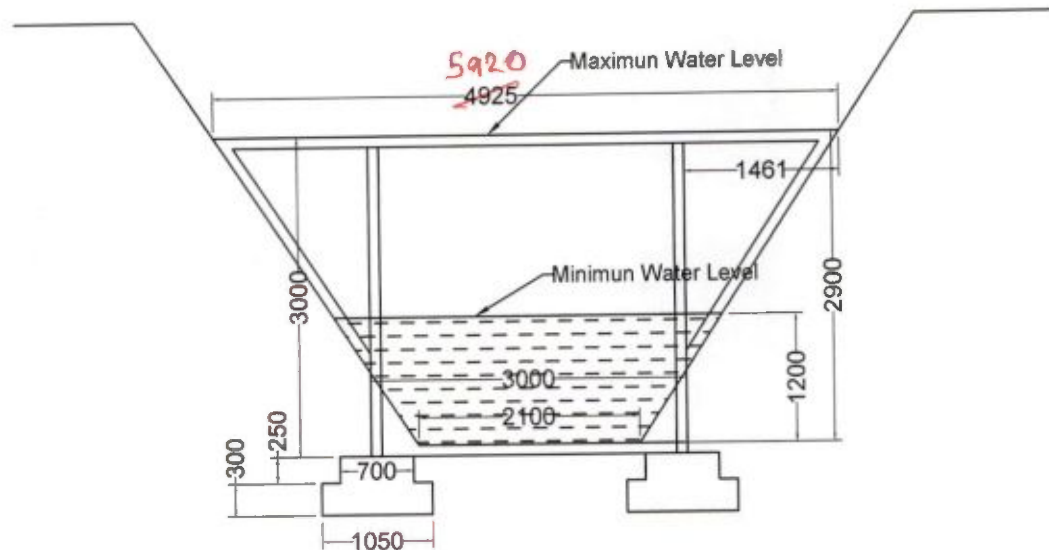

SECTIONAL PLAN OF DRAIN
(AT CHAINAGE 75M FROM OUT FALL POINT)

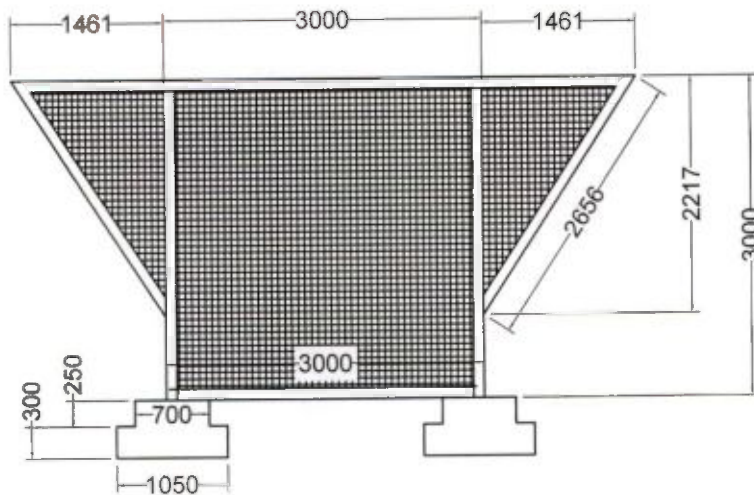

SECTIONAL PLAN OF GRATING

[Signature]
 Assistant Engineer,
 East Medinipur Division
 (M. E. Dte.) Tamluk
 Govt. of West Bengal

Vetted
[Signature]
 Executive Engineer,
 East Medinipur Division
 (M. E. Dte.) Tamluk
 Govt. of West Bengal

[Signature]
 K. PANJA
 Sub-Assistant Engineer
 Tamralipta Municipality

TAMRALIPTA MUNICIPALITY
TAMLUK :: PURBA MEDINIPUR
DETAIL MEASUREMENTS AND CALCULATIONS

Detailed Estimate No. :-

for the year 200 to 200

Name of works :-

Estimate for Construction of Screening arrangement across the drain at Kapasbaria in Ward No - 19, within Tamralipta Municipality

(Rate as per P. W. D. Schedule of Rates effected from 1st November 2017 & 3rd Corriganda w.e.f. 04.06.2018)

Sl. No.	Description of work	Unit	No	Length	Breadth	Height / Depth	Quantity	Rate	Amount
1	Page No - 01, Item No - 02 Earth work in excavation of foundation trenches drain, in all sorts of soil (including mixed soil spreading or stacking the spoils within a lead of 75m. as directed. The item includes and ramming the Bottombailing out water as required complete. a) Depth of excavation not exceeding 1500mm.	Cum	2	1.200	1.200	0.650	1.87	143	
		Cum	2	1.200	1.200	0.900	2.59	198	406.71
	Total Qty.	Cum					4.46	119.27	531.94
2	Page No - 02, Item No - 04 Filling in foundation or plinth by silver sand in layers not exceeding 150mm. As directed and consolidating same by thorough saturation with water ramming complete, including the cost of supply of sand. (Payment to be made on measurement of finished quantity). a) Do-by fine sand	Cum	2	1.200	1.200	0.075	0.16		86.96
	Total Qty.	Cum					0.22	543.51	419.57
3	Page No - 23, Item No - 01 Cement concrete with graded Jhama Khoa (30mm size) excluding shuttering. In ground floor and foundation. (a) 6:3:1 proportion	Cum	2	1.200	1.200	0.075	0.16		639.10
	Total Qty.	Cum					0.22	4306.87	976.58
4	Page No - 26, Item No - 10 Ordinary Cement concrete (mix 1:1.5:3) with graded stone chips (20 mm nominal size) excluding shuttering and reinforcement if any, in ground floor as per relevant IS codes	Cum	2	1.050	1.050	0.300	0.66		
		Cum	2	0.700	0.700	0.250	0.25		
	Total Qty.	Cum					0.91	5541.66	5042.31
								5777.32	5257.36

Estimate for Construction of Screening arrangement across the drain at Kapasbaria in Ward No. 19, within Tamralipta Municipality

(Rate as per P. W. D. Schedule of Rates effected from 1st November 2017 & 3rd Corriganda w.e.f. 04.06.2018)

Sl. No.	Description of work	Unit	No	Length	Breadth	Height / Depth	Quantity	Rate	Amount
5	Page No - 42 , Item No - 36 Hire and labour charges for shuttering with centering and necessary staging upto 4m. using approved stout props and thick hard wood planks of approved thickness with required bracing for concrete slabs, beams, columns, lintels curved or straight including fitting, fixing and striking out after completion of works. (up to roof of ground floor) (When the height of a particular floor is more than 4m. the equivalent floor ht. Shall be taken as 4m. and extra for works beyod the initial 4m. ht. Shall be allowed under 12(e) for every 4m. or part thereof.) a) 25 mm to 30 mm thick wooden shuttering as per dicission direction of engineer in charge. i) In foundation & ground floor.	Sqm	8	1.050		0.300	2.52		
		Sqm	8	0.700		0.250	1.40		
	Total Qty.	Sqm					3.92	205.00	803.60
6	Page No - 43 , Item No - 40 Reinforcement for reinforced concrete work in the all sorts of structures including distribution bars, stirrups, binders etc. including supply of rods, initial straightening and removal of loose rust (if necessary)cutting to requisite length, hooking & bending to correct shape, placing in proper position and binding with 16 gauge black annealed wire at every intersection, complete as per drawing and direction. (a) For works in foundation, basement and upto roof of ground floor / upto 4 m. (i) Tor steel / Mild steel.	MT					0.071		
	;1% of Concrete Qty.	MT					0.071	48785.87	3463.80
	Total Qty.	MT					0.071	52938.20	3758.61
7	Page No - 101, Item No - 01 M.S. structural works in columns, beams etc. with simple rolled structural members (e.g. joists, angle, channel sections conforming to IS: 226, IS: 808 & SP (6)- 1964 connected to one another with bracket, gussets, cleats as per design, direction of Engineer-in-charge complete including cutting to requisite shape and length, fabrication with necessary bolting, metal arc welding conforming to IS: 816- 1969 & IS: 1995 using electrodes of approved make and brand conforming to IS:814- 2004, haulage, hoisting and erection all complete. The rate includes the cost of rolled steel section, consumables such as electrodes, gas and hire charge of all tools and plants and labour required for the work including all incidental chages such as electricity charges, labour insurance charges etc. II) For Structural Works in Roof Trusses etc. using joists, channels and angles of specified section weighing less than 22.5 kg/ m	Kg	2	3.000		16.800	100.80		
		Kg	1	3.000		16.800	50.40		
		Kg	1	5.920		16.800	99.46		
		Kg	2	2.655		16.800	89.21		
	Total Qty.in Kg	Kg					339.87	72603.00	24685.02
	Total Qty.	MT					0.340	60276.00	20493.84

Estimate for Construction of Screening arrangement across the drain at Kapasbaria in Ward No - 19, within Tamralipta Municipality

(Rate as per P. W. D. Schedule of Rates effected from 1st November 2017 & 3rd Corriganda w.e.f. 04.06.2018)

Sl. No.	Description of work	Unit	No	Length	Breadth	Height / Depth	Quantity	Rate	Amount
---------	---------------------	------	----	--------	---------	----------------	----------	------	--------

8 Page No - 104, Item No - 12

M.S. works in framed gratings of window etc.made of round or square bars and frame work or M.S. flats (with the bars securely fixed to the flat bar frame) with or without intermediate flat bar stiffener and fixed with necessary screws etc. complete, as directed.
In ground floor.

		Kg	1	3.000	3.000	35.000	315.00		
4x0.5		Kg	2 $\frac{1}{2}$	1.460	2.655	35.000	271.00	135.67	
Total Qty.	322	Kg					586.00	66.99	39256.14

9 Page No - 45, Item No - 06-16-21 PWD Road sche

Cleaning the exposed reinforcement preferably upto full diameter by wire brush, applying two coats of polymer based rust removing compound left for 24 hours, removing the coating and then applying two (2) coats of polymer modified anti corrosive protective coating formulated to inhibit the corrosion of reinforcement as per manufacturer's specification] [Mode of measurement: The affected surface area of reinforcement shall be considered for payment]

		Sqm	1	3.000	3.000		9.00		
		Sqm	2 $\frac{1}{2}$	1.460	2.655		8.00	3.87	
Total Qty.		Sqm					17.00	785.00	13345.00
		Total					12.87		
								Rs.	84542.64
Add @ 12.00% SGST(6%) & CGST(6%)									81452.93
							Rs	9774.35	10145.12
Total Amount							Rs	99227.28	94687.76
Add @ 1.00% Labour welfare Cess							Rs	912.27	946.88
Add @ 3.00% Contengensis							Rs	2936.82	2840.63
Total							Rs	94876.37	98475.27

Say Rs. 94876.00 98475.00

(Rupees ninety four thousand eight hundred seventy six) only

K. Panja
10/12/19
K. PANJA
Sub-Assistant Engineer
Tamralipta Municipality

[Signature]
Chairman
Tamralipta Municipality

May be vetted
[Signature]
12/12/19
Junior Engineer,
East Medinipur Division
(M.E. Dte.) Tamruk
Govt. of West Bengal

May be vetted
[Signature]
12/12/19
Assistant Engineer,
East Medinipur Division
(M.E. Dte.) Tamruk
Govt. of West Bengal

Vetted
[Signature]
12/12/19
Executive Engineer,
East Medinipur Division
(M.E. Dte.) Tamruk
Govt. of West Bengal

CROSS SECTION OF DRAIN - 9 AT KAPASBARIA IN WRAD NO - 19 WITHIN TAMRALIPTA MUNICIPALITY

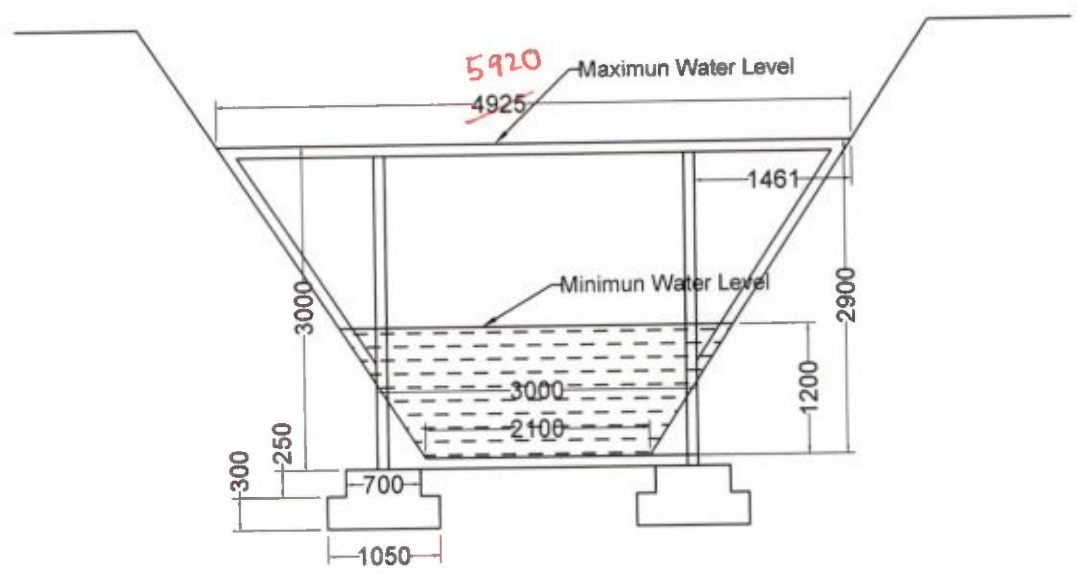

SECTIONAL PLAN OF DRAIN
(AT CHAINAGE 75M FROM OUT FALL POINT)

[Signature]
14.12.19

Assistant Engineer,
East Medinipur Division
(M.E. Dte.) Tamluk
Govt. of West Bengal

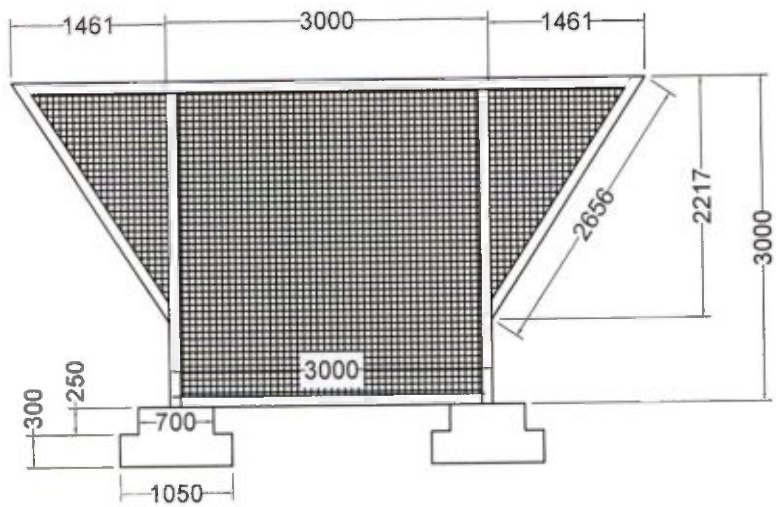

SECTIONAL PLAN OF GRATING

Vetted
[Signature]
17/12/19

Executive Engineer,
East Medinipur Division
(M.E. Dte.) Tamluk
Govt. of West Bengal

[Signature]
10.12.19
L. PANJA

Sub-Assistant Engineer
Tamralipta Municipality

**EXTRACT COPY OF THE RESOLUTION NO. 54 OF THE MEETING OF THE
BOARD OF COUNCILLORS OF TAMRALIPTA MUNICIPALITY.
HELD ON FRIDAY, 29.11.2019 AT 3.00 P.M.**

A meeting of the Board of Councillors of Tamralipta Municipality held at municipal office on Friday, 29.11.2019.

MEMBERS PRESENT

1.	Shri Rabindra Nath Sen	Chairman
2.	Shri Dipendra Narayan Roy	Vice-Chairman
3.	Shri Saktiprashad Bhattacharya	Councillor
4.	Anowara Begam	Councillor
5.	Shri Chandan Dey	Councillor
6.	Shri Bhanupada Saha	Councillor
7.	Smt. Ranjita Jana	Councillor
8.	Smt. Baisakhi Maity Panrah	Councillor
9.	Shri Jharupada Barman	Councillor
10.	Shri Biswajit Dutta	Councillor
11.	Shri Chanchal Khanra	Councillor
12.	Shri Subrata Roy	Councillor
13.	Smt. Sampa Rani Bera	Councillor
14.	Shri Alok Santra	Councillor
15.	Shri Chandan Pradhan	Councillor
16.	Smt. Lina Mabhai Roy	Councillor
17.	Sufia Bibi	Councillor
18.	Shri Prithwis Nandy	Councillor

Agenda No. 54 :

The BOC has thoroughly discussed about the proposal for construction of screening arrangement across the drain in different Mouzas and Wards within this municipality with the financial assistance of the M.A. & U.D. Department, Govt. of W.B. and the B.O.C. also decided to forward the following proposal for vetting.

Sl No	Description of Work	Value of Work		
		Estimate Value	Rs.	
1	Construction of screening arrangement across the drain at Sayedpur, in Ward No.- 02 and at Ratnali in Ward No.- 03 within Tamralipta Municipality.	Estimate Value	Rs.	135063.00
2	Construction of screening arrangement across the drain at Radhaballavpur, in Ward No.- 03 within Tamralipta Municipality.	Estimate Value	Rs.	92261.00
3	Construction of screening arrangement across the drain at Padumbasan, in Ward No.- 05 within Tamralipta Municipality.	Estimate Value	Rs.	15942.00
4	Construction of screening arrangement across the drain at Utarchara Sankarara, in Ward No.- 14 within Tamralipta Municipality.	Estimate Value	Rs.	15942.00

Attested

08.12.2019

**Chairman
Tamralipta Municipality**

Sl No	Description of Work	Value of Work		
		Estimate Value	Rs.	
5	Construction of screening arrangement across the drain at Salgechia, in Ward No.- 17 within Tamralipta Municipality.	Estimate Value	Rs.	15942.00
6	Construction of screening arrangement across the drain at Daharpur & Dharinda, in Ward No.- 16 & 20 within Tamralipta Municipality.	Estimate Value	Rs.	98475.00
8	Construction of screening arrangement across the drain at Sankarara, in Ward No.- 17 within Tamralipta Municipality.	Estimate Value	Rs.	15942.00
9	Construction of screening arrangement across the drain at D.C. Sankarara, in Ward No.- 15, 18 & 19 within Tamralipta Municipality.	Estimate Value	Rs.	196903.00
10	Construction of screening arrangement across the drain at Kapsberia, in Ward No.- 19 within Tamralipta Municipality.	Estimate Value	Rs.	98475.00
11	Construction of screening arrangement across the drain at Kapsberia, in Ward No.- 19 within Tamralipta Municipality.	Estimate Value	Rs.	98475.00
TOTAL AMOUNT RS.-				7,83,420.00

S/d-

Chairman, 29.11.2019
Tamralipta Municipality.

Attested
By 03.12.2019
Chairman
Tamralipta Municipality

Report on 16.03.2020

Details of Outfalls under HMC, where net has been fitted/to be fitted.

River Stretch:			Priority:		Remark
Drain	Type Domestic/ industrial/ mixed	Quantity (MLD)	BOD (mg/l)	FC (MPN/100ml)	
1.	Howrah Drainage Channel				Under Irrigation Dept.
2.	B Garden Khal				HMC (Work under progress)
3.	Swarnamoyee Khal				Under Irrigation Dept.
4.	Under Ground Drain near Shalimar Gate No.-1				HMC (Work under progress)
5.	Jagat Banerjee Ghat Road (Near Shibpur Burning Ghat)				HMC (Work Completed)
6.	Forshore Road near KMWSA Pump House				HMC (Work Completed)
7.	Ramkrishnapur Ghat (Near Mullick Ghat Road)				HMC (Work Completed)
8.	Telkal Ghat Road (Nityadhan Mukherjee Road)				Not yet Started
9.	Kings Road (Near Salt Gola Ghat)				Under KMDA (Work Completed as reported by KMDA.)
10.	Golabari Ghat Road				Under KMDA (Work Completed as reported by KMDA.)
11.	Kisanlal Burman Road (Badha Ghat - I)				HMC (Work Completed)
12.	Kisanlal Burman Road (Badha Ghat - II)				HMC (Work Completed)
13.	J.N. Mukherjee Road & River Hooghly (Side of Hanuman Gate Mill)				Under KMDA (Work done by HMC)

14.	Jayabibi Road				HMC (Work Completed)
15.	Akshay Dutta Lane				HMC (Work Completed)
16.	Mahendra Bagchi Lane				HMC (Work Completed)
17.	Daws Temple Road				Private (Work not started)
18.	Ghoshes Lane				HMC (Work Completed)
19.	Nichu Sk. Lane				HMC (Work Completed)
20.	Lalababu Shire Road				HMC (Work Completed)
21.	B.K. Paul Temple Road				HMC (Work Completed)
22.	Ramlochon Shire Street				HMC (Work Completed)
23.	A.N. Pal Lane				HMC (Work Completed)
24.	Ashutosh Mukherjee Lane				HMC (Work Completed)
25.	Near Bally Nursing Home				HMC (Work Completed)
26.	Gossai Ghat Road				HMC (Work not started)
27.	Bagdi Para near Forshore Road, Shibpur				HMC (Work started yet to be Completed)
28.	Bally BOC Ground				HMC (Work Completed)

Executive Engineer
Howrah Municipal Corporation

Director, SUDA

Re.: Submission of status of screening for drain discharging into the river Ganga to SBM cell, SUDA as per direction of the Chairperson of High Power State Level Committee constituted under the direction of Hon'ble National Green Tribunal (NGT)

1. Name of the Municipality/Municipal Corporation : The Kolkata Municipal Corporation
2. Total no. of outfall/discharging point which discharge to river Ganga : 09 No.s
3. No. of outfall point under control of Municipality/ Municipal Corporation : 09 No.s
4. No. of Outfall point under control of other than Municipality/ Municipal Corporation :pNIL
5. If any, mention the controlling authority : N/A
6. No. of outfall where screens was already exists : 01 [One]
7. No. of outfall having screens provided at present : 08 No.s [12 No.s Screen]
8. No. of screens installed : Installation of 12 no.s screens completed on 03.09 2019.
9. No. of outfall point without screening : Nil
10. Reason, if any : N/A

[Signature]
22/02/2020
Asstt. Engineer (C)/S&D(S)

[Signature]
22/02/2020
Ex. Engineer (C)/S&D(S)
E. E. (C)/S & D (S)
THE KOLKATA MUNICIPAL CORPORATION

[Signature]
22/2/20
DG[S&D]
Director General
Sewerage & Drainage

9932354032

Received via e-mail
from KMC on 22/2/2020.
1:38 Pm.



Mailed
on 12/12/20



রাজ্য নগর উন্নয়ন সংস্থা

STATE URBAN DEVELOPMENT AGENCY

“ইলগাস ভবন”, এইচ-সি ব্লক, সেক্টর-৩, বিধাননগর, কলকাতা-৭০০ ১০৬, পশ্চিমবঙ্গ

“ILGUS BHAVAN”, H-C Block, Sector - III, Bidhannagar, Kolkata - 700 106, West Bengal

ক্রমিক নং SUDA-229/2018/9363

তারিখ 12.02.20

From: Director, SUDA.

To: The Chairperson,
Bansberia Municipality,
Hoogly.

Sub: Requirement of fund for providing screens across channel/drain discharging to river Ganga within Bansberia Municipality.

Ref: Your Memo no: 4382 dated: 03.01.20

Madam,

In reference to the above this is to remind you that in the meeting, on Municipal Solid Waste Management and Monitoring of Ganga Towns, held on 10th July, 2019 at SUDA Conference Hall, a decision has been taken that work related to screening on small nullah/drain up to the size of 1.2m x 1.2m to be executed by the Municipal Authority of its own. Reimbursement of funds for installation of screens above 1.2m x 1.2m may be claimed with work done estimate duly vetted by the concerned Executive Engineer of KMDA/M.E.Dte. The copy of the said minutes is being attached herewith for your ready reference please.

You are therefore requested to kindly send reimbursement claim for screen installation on drains of size above 1.2m X 1.2m.

Encl: As stated above

Yours faithfully,

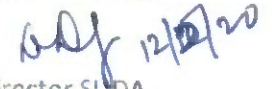
Director, SUDA

দূরভাষ : ২৩৫৮ ৬৪০৩ / ৫৭৬৭, ফ্যাক্স : ২৩৫৮ ৫৮০০

Tel : 2358 6403/5767, Fax : 2358 5800, E-mail : wbsudadir@gmail.com

Account Section : 2358 6408

Draft

From: Director, SUDA.

To: The Chairperson,
Bansberia Municipality,
Hoogly.

Sub: Requirement of fund for providing screens across channel/drain discharging to river
Ganga within Bansberia Municipality.
Ref: Your Memo no: 4382 dated: 03.01.20

Sir/Madam, *Sir,*

In reference to the above this is to remind you that in the meeting, on Municipal Solid Waste Management and Monitoring of Ganga Towns, held on 10th July, 2019 at SUDA Conference Hall, a decision has been taken that work related to screening on small nullah/drain up to the size of 1.2m x 1.2m to be executed by the Municipal Authority of its own. Reimbursement of funds for installation of screens above 1.2m x 1.2m may be claimed with work done estimate duly vetted by the concerned Executive Engineer of KMDA/M.E.Dte. The copy of the said minutes is being attached herewith for your ready reference please.

You are therefore requested to kindly send reimbursement claim for screen installation on drains of size above 1.2m X 1.2m.

Thanking you,

Encl: As stated above

Yours faithfully,



Director, SUDA

Memo No: 4382

The Director, SUDA & State Mission Director, SBM
Government of West Bengal, "ILGUS BHAVAN",
H-C Block, Sector - III, Bidhannagar,
Kolkata - 700 106, West Bengal.



Date: 3/1/2020

EE(SD)
SPMG copy not enclosed.
LSP

Sub: Screening on outfalls to river Ganga – Request for Administrative Approval and Financial Sanction and Allotment of Funds

Madam,

A photocopy of Project Director, WBSPMG & CEO, KMDA letter bearing No. 1758-NGRBA /SPMG/Ganga Committee-374/2017(P-1) dated 8th March 2019 on the subject mentioned above, along with enclosures, is enclosed for your kind perusal.

I would now draw your kind attention to the fact that we have installed the screens and have the "Details of screening on all the 16 outfalls to River Ganga for arresting solid waste". According to the amount vetted by the KMDA the expenditure for the implementation of the proposal is given in the enclosed Abstract of work.

Under the above circumstances, I request you to kindly issue instructions for the expeditious Administrative Approval and Financial Sanction and Allotment of Funds.

Yours faithfully

Asd 03.1.20
Chairperson
Bansberia Municipality
Chairperson
Bansberia Municipality

Enco: Photocopy of letter as stated above along with Abstract and Work order's

Memo no:

Date:

Copy forwarded for kind information and necessary action to:

(1) The Chief Executive Officer, Kolkata Metropolitan Development Authority, Unnayan Bhavan,
DJ - 11, Scc - II, Salt Lake, Kolkata – 700091.

Chairperson
Bansberia Municipality



Asst. S. Chatterjee
for 13/01/2020

BANSBERIA MUNICIPALITY

BANSBERIA, HOOGHLY

Sl. No.	Name of Work	Type / Size of Net	Qty.	Rate for Size	Amount
1	Construction of Catch Pit and Supplyong, Fitting and Fixing Iron Net at the Out Fall of Surface Drain & Pipe Drain of River Ganga (River Hooghly) for Preventing Plastic and other Solid Materials in Ward No. 02, 03, 04. (Under West Bengal State NGRBA Programme Fund)	i) 2.50 m X 2.50 m	1 x 2 = 2 Nos.	₹ 39,743.00	₹ 79,486.00
		ii) 3.00 m X 3.00 m	1 x 2 = 2 Nos.	₹ 49,321.00	₹ 98,642.00
		iii) 4.00 m X 4.00 m	2 x 2 = 4 Nos.	₹ 73,076.00	₹ 2,92,304.00
		Total Amount			₹ 4,70,432.00
2	Construction of Catch Pit and Supplyong, Fitting and Fixing Iron Net at the Out Fall of Surface Drain & Pipe Drain of River Ganga (River Hooghly) for Preventing Plastic and other Solid Materials in Ward No. 06, 07. (Under West Bengal State NGRBA Programme Fund)	i) 3.00 m X 3.00 m	4 x 2 = 8 Nos.	₹ 49,321.00	₹ 3,94,568.00
				Total Amount	₹ 3,94,568.00
3	Construction of Catch Pit and Supplyong, Fitting and Fixing Iron Net at the Out Fall of Surface Drain & Pipe Drain of River Ganga (River Hooghly) for Preventing Plastic and other Solid Materials in Ward No. 12, 13, 20. (Under West Bengal State NGRBA Programme Fund)	i) 2.50 m X 2.50 m	4 x 2 = 8 Nos.	₹ 39,743.00	₹ 3,17,944.00
		ii) 4.00 m X 4.00 m	1 x 2 = 2 Nos.	₹ 73,076.00	₹ 1,46,152.00
				Total Amount	₹ 4,64,096.00
4	Construction of Catch Pit and Supplyong, Fitting and Fixing Iron Net at the Out Fall of Surface Drain & Pipe Drain of River Ganga (River Hooghly) for Preventing Plastic and other Solid Materials in Ward No. 08, 09. (Under West Bengal State NGRBA Programme Fund)	i) 2.50 m X 2.50 m	1 x 2 = 2 Nos.	₹ 39,743.00	₹ 79,486.00
		ii) 3.00 m X 3.00 m	1 x 2 = 2 Nos.	₹ 49,321.00	₹ 98,642.00
		iii) 4.00 m X 4.00 m	1 x 2 = 2 Nos.	₹ 73,076.00	₹ 1,46,152.00
		Total Amount			₹ 3,24,280.00
Grand Total Amount					₹ 16,53,376.00



Member
03.01.2020

Chairperson
Bansberia Municipality

etc

OFFICE OF THE MUNICIPAL COUNCILLORS OF BANSBERIA
Rudra Main Raod, P.O. Bansberia, Dist. Hooghly, West Bengal, PIN – 712502
Ph. No. 033-26346324, Fax No. 26346806, email address: bansb_04@yahoo.com

Memo No.:- 2771

Dated:- 18.9.19

From :- Smt. Arijita Sil,
Chairperson,
Bansberia Municipality.

TN-3 (19-20), Sl.- 31

To :- Barun Kumar Sett,
Bansberia Kundu Goli,
Bansberia, Hooghly.

Dear Sir,

Your tender dt. 02/09/2019 for the work named below has been accepted. You are requested to take up the work immediately and the work must be completed within **15 days** from the date of agreement. You are to give an undertaking in writing regarding completion of the work in schedule time.

As regards collections of materials for execution of the work, the materials will have to be produced by you and the Municipality will not take the responsibility of supplying **sand, cement, etc.** as required for the work. As regards utilization of materials, the same must be approved by the authorized person of this office.

Please note that the work should be started after due intimation to the office. If any one takes up the work without intimation, the Municipality shall not take any responsibility of the work to done by you.

The work to be done under the supervision of municipality staff and no payment will be made for any work in excess of work of the items specified in the specification enclosed with this order, unless such excess work is ordered in writing by the undersigned.

As regards rate of payment, your tender rate with own supply of materials has been accepted.

The contractor himself or his authorized representative should be present at the site during execution of the job.

An agreement should be executed on non-judicial stamp paper worth Rs. 10/- (Rupees Ten) within seven days from the date of receipt of this work order, otherwise the work if started without prior execution of the Agreement, will be treated as without permission of the municipality.

Tender Sl. No.	Name of Work	Estimated Value (Rs.)	Accepted tender Rate
31	Construction of Catch Pit and Supplying, fitting and fixing Iron Nett at the outfall of Surface Drain & Pipe Drain of River Ganga (River Hooghly) for preventing plastic and other solid materials in Ward No. 6, 7 (Under West Bengal State NGRBA Programme Fund)	Rs. 3,94,568/-	0.05 % Less

Chairperson
Bansberia Municipality
Chairperson
Bansberia Municipality
18.09.19

OFFICE OF THE MUNICIPAL COUNCILLORS OF BANSBERIA
Rudra Main Raod, P.O. Bansberia, Dist. Hooghly, West Bengal, PIN – 712502
Ph. No. 033-26346324, Fax No. 26346806, email address: bansb_04@yahoo.com

Memo No.: 2771/1(10)

Dated:- 18.9.19

Copy forwarded to :-

1. The Executive Officer, Bansberia Municipality, Bansberia, Hooghly.
2. Finance Officer, Bansberia Municipality, Bansberia, Hooghly.
3. C.I.C. (PWD), Bansberia Municipality.
4. Ward Councillor, Ward No. ...6 & 7..... for favour of his/her information.
5. S.A.E/A.E./W.W.S., Sri.....
6. Head Clerk
7. Accountant-in-Charge
8. Ward Supervisor, Ward No.....6 & 7.....

The contractor should not be allowed to do any excess work without written order from the undersigned, if any work is felt necessary, he shall have to report the matter to the undersigned immediately and take instruction in writing from the office.

He is also directed, not to take measurement for any work done by the contractor, in excess of the volume of works covered by the above noted work order except under writing order from the undersigned.

Chairperson
Bansberia Municipality
Bansberia Municipality
18.09.19

e/c

OFFICE OF THE MUNICIPAL COUNCILLORS OF BANSBERIA
Rudra Main Raod, P.O. Bansberia, Dist. Hooghly, West Bengal, PIN – 712502
Ph. No. 033-26346324, Fax No. 26346806, email address: bansb_04@yahoo.com

Memo No.:- 2772

Dated:- 18.9.19

From :- Smt. Arijita Sil,
Chairperson, Bansberia Municipality.

TN-3 (19-20), Sl.- 32

To :- M/s. Sarkar Enterprise,
Shibpur Hazrapara, Tribeni, Hooghly.

Dear Sir,

Your tender dt. 02/09/2019 for the work named below has been accepted. You are requested to take up the work immediately and the work must be completed within 20 days from the date of agreement. You are to give an undertaking in writing regarding completion of the work in schedule time.

As regards collections of materials for execution of the work, the materials will have to be produced by you and the Municipality will not take the responsibility of supplying cement, sand, etc. as required for the work. As regards utilization of materials, the same must be approved by the authorized person of this office.

Please note that the work should be started after due intimation to the office. If any one takes up the work without intimation, the Municipality shall not take any responsibility of the work to done by you.

The work to be done under the supervision of municipality staff and no payment will be made for any work in excess of work of the items specified in the specification enclosed with this order, unless such excess work is ordered in writing by the undersigned.

As regards rate of payment, your tender rate with own supply of materials has been accepted.

The contractor himself or his authorized representative should be present at the site during execution of the job.

An agreement should be executed on non-judicial stamp paper worth Rs. 10/- (Rupees Ten) within seven days from the date of receipt of this work order, otherwise the work if started without prior execution of the Agreement, will be treated as without permission of the municipality.

Tender Sl. No.	Name of Work	Estimated Value (Rs.)	Accepted tender Rate
32	Construction of Catch Pit and Supplying, fitting and fixing Iron Nett at the outfall of Surface Drain & Pipe Drain of River Ganga (River Hooghly) for preventing plastic and other solid materials in Ward No. 12, 13, 20 (Under West Bengal State NGRBA Programme Fund)	Rs. 4,64,096/-	0.10 % Less

Chairperson
Bansberia Municipality
Chairperson
Bansberia Municipality
18-09-19

OFFICE OF THE MUNICIPAL COUNCILLORS OF BANSBERIA
Rudra Main Raod, P.O. Bansberia, Dist. Hooghly, West Bengal, PIN – 712502
Ph. No. 033-26346324, Fax No. 26346806, email address: bansb_04@yahoo.com

Memo No.:- 2772/1(12)

Dated:- 18.9.19

Copy forwarded to :-

1. The Executive Officer, Bansberia Municipality, Bansberia, Hooghly.
2. Finance Officer, Bansberia Municipality, Bansberia, Hooghly.
3. C.I.C. (PWD), Bansberia Municipality.
4. Ward Councillor, Ward No.12, 13 & 20..... for favour of his/her information.
5. S.A.E/A.E./W.W.S., Sri.....
6. Head Clerk
7. Accountant-in-Charge
8. Ward Supervisor, Ward No.....12, 13 & 20.....

The contractor should not be allowed to do any excess work without written order from the undersigned, if any work is felt necessary, he shall have to report the matter to the undersigned immediately and take instruction in writing from the office.

He is also directed, not to take measurement for any work done by the contractor, in excess of the volume of works covered by the above noted work order except under writing order from the undersigned.

Chairperson
Bansberia Municipality
Chairperson
Bansberia Municipality 18.09.19

o/c

OFFICE OF THE MUNICIPAL COUNCILLORS OF BANSBERIA
Rudra Main Raod, P.O. Bansberia, Dist. Hooghly, West Bengal, PIN – 712502
Ph. No. 033-26346324, Fax No. 26346806, email address: bansb_04@yahoo.com

Memo No.:- 2773

Dated:- 18.9.19

From :- Smt. Arijita Sil,
Chairperson,
Bansberia Municipality.

TN-3 (19-20), Sl.- 33

To :- Arun Kumar Sett,
Bansberia Kundu Goli, Bansberia, Hooghly.

Dear Sir,

Your tender dt. 02/09/2019 for the work named below has been accepted. You are requested to take up the work immediately and the work must be completed within **15 days** from the date of agreement. You are to give an undertaking in writing regarding completion of the work in schedule time.

As regards collections of materials for execution of the work, the materials will have to be produced by you and the Municipality will not take the responsibility of supplying **cement, sand, etc.** as required for the work. As regards utilization of materials, the same must be approved by the authorized person of this office.

Please note that the work should be started after due intimation to the office. If any one takes up the work without intimation, the Municipality shall not take any responsibility of the work to done by you.

The work to be done under the supervision of municipality staff and no payment will be made for any work in excess of work of the items specified in the specification enclosed with this order, unless such excess work is ordered in writing by the undersigned.

As regards rate of payment, your tender rate with own supply of materials has been accepted.

The contractor himself or his authorized representative should be present at the site during execution of the job.

An agreement should be executed on non-judicial stamp paper worth Rs. 10/- (Rupees Ten) within seven days from the date of receipt of this work order, otherwise the work if started without prior execution of the Agreement, will be treated as without permission of the municipality.

Tender Sl. No.	Name of Work	Estimated Value (Rs.)	Accepted tender Rate
33	Construction of Catch Pit and Supplying, fitting and fixing Iron Nett at the outfall of Surface Drain & Pipe Drain of River Ganga (River Hooghly) for preventing plastic and other solid materials in Ward No. 8, 9 (Under West Bengal State NGRBA Programme Fund)	3,24,280.00	At Par

 Chairperson
 Bansberia Municipality
 Chairperson
 Bansberia Municipality



OFFICE OF THE MUNICIPAL COUNCILLORS OF BANSBERIA
Rudra Main Raod, P.O. Bansberia, Dist. Hooghly, West Bengal, PIN – 712502
Ph. No. 033-26346324, Fax No. 26346806, email address: bansb_04@yahoo.com

Memo No.:- 2773/1(10)

Dated:- 18.9.19

Copy forwarded to :-

1. The Executive Officer, Bansberia Municipality, Bansberia, Hooghly.
2. Finance Officer, Bansberia Municipality, Bansberia, Hooghly.
3. C.I.C. (PWD), Bansberia Municipality.
4. Ward Councillor, Ward No. ...8 & 9..... for favour of his/her information.
5. S.A.E/A.E./W.W.S., Sri.....
6. Head Clerk
7. Accountant-in-Charge
8. Ward Supervisor, Ward No.....8 & 9.....

The contractor should not be allowed to do any excess work without written order from the undersigned, if any work is felt necessary, he shall have to report the matter to the undersigned immediately and take instruction in writing from the office.

He is also directed, not to take measurement for any work done by the contractor, in excess of the volume of works covered by the above noted work order except under writing order from the undersigned.

Asil
Chairperson
Bansberia Municipality
Chairperson
Bansberia Municipality
18/9/19



OFFICE OF THE MUNICIPAL COUNCILLORS OF BANSBERIA

Rudra Main Road ,P.O: Bansberia,Dist: Hooghly , West Bengal,Pin -712502
Ph.no :033-26346324,Fax No. 033-26346806,Email address: bansb_04 @yahoo.com



Memo No.:-

Dated:-

From :- Smt. Arijita Sil,
Chairperson,
Bansberia Municipality.

To :- SHA-SIM,
88, Deshpriya Sarani,
Bansberia, Hooghly.

Tender Details	
TN No.	TN-03_2 nd Call_(19-20)
Date :	25/11/2019
Sl. No.	08

Dear Sir,

Your tender dt. **09/12/2019** for the work named below has been accepted. You are requested to take up the work immediately and the work must be completed within **20 days** from the date of agreement. You are to give an undertaking in writing regarding completion of the work in schedule time.

As regards collections of materials for execution of the work, the materials will have to be produced by you and the Municipality will not take the responsibility of supplying **Cement, Sand, etc.** as required for the work. As regards utilization of materials, the same must be approved by the authorized person of this office.

Please note that the work should be started after due intimation to the office. If any one takes up the work without intimation, the Municipality shall not take any responsibility of the work to done by you.

The work to be done under the supervision of municipality staff and no payment will be made for any work in excess of work of the items specified in the specification enclosed with this order, unless such excess work is ordered in writing by the undersigned.

As regards rate of payment, your tender rate with own supply of materials has been accepted.

The contractor himself or his authorized representative should be present at the site during execution of the job.

An agreement should be executed on non-judicial stamp paper worth Rs. 10/- (Rupees Ten) within three days from the date of receipt of this work order, otherwise the work if started without prior execution of the Agreement, will be treated as without permission of the municipality.

Tender Sl. No.	Name of Work	Estimated Value (Rs.)	Accepted Tender Rate
08	Construction of Catch Pit and Supplying, fitting and fixing Iron Nett at the outfall of Surface Drain & Pipe Drain of River Ganga (River Hooghly) for preventing plastic and other solid materials in Ward No. 2, 3, 4 (Under West Bengal State NGRBA Programme Fund)	Rs. 4,70,432/-	@ At Par

Sd/-
Chairperson
Bansberia Municipality



OFFICE OF THE MUNICIPAL COUNCILLORS OF BANSBERIA

Rudra Main Road ,P.O: Bansberia,Dist: Hooghly ,West Bengal,Pin -712502
Ph.no :033-26346324,Fax No. 033-26346806,Email address: bansb_04 @yahoo.com



Memo No.:-

4175/1/129

Dated:-20/12/19

Copy forwarded to :-

1. The Executive Officer, Bansberia Municipality, Bansberia, Hooghly.
2. Finance Officer, Bansberia Municipality, Bansberia, Hooghly.
3. C.I.C. (P.W.D.), Bansberia Municipality.
4. Ward Councillor, Ward No.2,3,4.....for favour of his/her information.
5. S.A.E/W.W.S., Sri.....
6. Head Clerk
7. Accountant.
8. W.S. in Ward No.....2,3,4.....

The contractor should not be allowed to do any excess work without written order from the undersigned, if any work is felt necessary, he shall have to report the matter to the undersigned immediately and take instruction in writing from the office.

He is also directed, not to take measurement for any work done by the contractor, in excess of the volume of works covered by the above noted work order except under writing order from the undersigned.

Asal
Chairperson
Bansberia Municipality
Chairperson
Bansberia Municipality
Member
17/12/19

Rate Analysis of Grating 2.5 m X 2.5 m (Type 1)

Sl no.	Particulars of Item	Amount (Rs.)
1	M.S. structural works in columns, beams etc. with simple rolled structural members (e.g. joists, angle, channel sections conforming to IS: 226, IS: 808 & SP (6)- 1964 connected to one another with bracket, gussets, cleats as per design, direction of Engineer-in-charge complete including cutting to requisite shape and length, fabrication with necessary bolting, metal arc welding conforming to IS: 816- 1969 & IS: 1995 using electrodes of approved make and brand conforming to IS:814- 2004, haulage, hoisting and erection all complete. The rate includes the cost of rolled steel section, consumables such as electrodes, gas and hire charge of all tools and plants and labour required for the work including all incidental chages such as electricity charges, labour insurance charges etc. (P.W.D 2017. (Building). IT No - 2A ; Pg.no - 101) For 2nos Channels in sides of grating = 2 x 3.5m @16.8 kg / meter = 117.6 kg. @ Rs. 60276 per M.T. = 0.1176 x 60276 = Rs. 7088.46	7088.46
2	M.S. works in framed gratings of window etc.made of round or square bars and frame work or M.S. flats (with the bars securely fixed to the flat bar frame) with or without intermediate flat bar stiffener and fixed with necessary screws etc. complete, as directed. (P.W.D 2017. (Building). IT No - 12 ; Pg.no - 104) Total - 2.5m X 2.5m @ 35 kg / sqm. = 218.75 kg @ Rs. 6299.00 per qntl. for 2.1875 Qntl.-	13779.06
3	Reinforced cement concrete - M - 20 1 Cum. @ Rs. 5837.86	5837.86
4	Steel reinforcement for R.C.C. work @ 1% of RCC volume - 78.5 kg @ Rs. 67081/MT	5265.86
5	Providing anti-corrosive protective coating to inhibit the corrosion to HYSD reinforcements including two coats of anti-corrosive coatings of consumption as per manufacturer's specification, cleaning etc. complete as per the direction of the Engineer-in- Charge. (P.W.D 2018. (Roads). IT No - 16.21 ; Pg.no - 322) Total , 2.5 x 2.5 = 6.25 Sqm. @ Rs. 506.00 per Sqm.	3162.5
	Total - Rs.	35133.74
	Adding 12% GST , Rs. -	4216.05
	Adding 1% Cess over GST added amount , Rs. -	393.50
	Total , Rs. -	39743.29
	Say , Rs. -	39743.00
In words - Rupees thirty nine thousand seven hundred forty three only		

S
11/03/19
(JE/WBD/W&S)

veted.
W&S
11/3/19

Rate Analysis of Grating 3.0 m X 3.0 m (Type 2)

Sl no.	Particulars of Item	Amount (Rs.)
1	M.S. structural works in columns, beams etc. with simple rolled structural members (e.g. joists, angle, channel sections conforming to IS- 226, IS- 808 & SP (6)- 1964 connected to one another with bracket, gussets, cleats as per design, direction of Engineer-in-charge complete including cutting to requisite shape and length, fabrication with necessary bolting, metal arc welding conforming to IS: 816- 1969 & IS: 1995 using electrodes of approved make and brand conforming to IS:814- 2004, haulage, hoisting and erection all complete. The rate includes the cost of rolled steel section, consumables such as electrodes, gas and hire charge of all tools and plants and labour required for the work including all incidental charges such as electricity charges, labour insurance charges etc. (P.W.D 2017. (Building). IT No - 2A ; Pg.no - 101) For 2nos. Channels in sides of grating = 2 x 4.0 m @16.8 kg / meter = 134.4 kg. @ Rs. 60276 per M.T. = 0.1344 x 60276	8101.09
2	M.S. works in framed gratings of window etc. made of round or square bars and frame work or M.S. flats (with the bars securely fixed to the flat bar frame) with or without intermediate flat bar stiffener and fixed with necessary screws etc. complete, as directed. (P.W.D 2017. (Building). IT No - 12 ; Pg.no - 104) Total - 3.0 m X 3.0 m @ 35 kg / sqm. = 315.0 kg @ Rs. 6299.00 per qntl. for 3.15 Qntl.-	19841.85
3	Reinforced cement concrete - M - 20 1 Cum. @ Rs. 5837.86	5837.86
4	Steel reinforcement for R.C.C. work @ 1% of RCC volume - 78.5 kg @ Rs. 67081/MT	5265.86
5	Providing anti-corrosive protective coating to inhibit the corrosion to HYSD reinforcements including two coats of anti-corrosive coatings of consumption as per manufacturer's specification, cleaning etc. complete as per the direction of the Engineer-in- Charge. (P.W.D 2018. (Roads). IT No - 16.21 ; Pg.no - 322) Total , 3.0 x 3.0 = 9.0 Sqm. @ Rs. 506.00 per Sqm.	4554
Total - Rs.		43600.66
Adding 12% GST , Rs. -		5232.08
Adding 1% Cess over GST added amount , Rs. -		488.33
Total , Rs. -		49321.07
Say , Rs. -		49321.00
In words - Rupees forty nine thousand three hundred twenty one only		

[Signature]
11/03/19
(WBD/GAP)

[Signature]
11/3/19

Rate Analysis of Grating 4.0 m X 4.0 m (Type 3)

Sl no.	Particulars of item	Amount (Rs.)
1	M.S. structural works in columns, beams etc. with simple rolled structural members (e.g. joists, angle, channel sections conforming to IS 226, IS 808 & SP (c) 1964 connected to one another with bracket, gussets, cleats as per design, direction of Engineer-in-charge complete including cutting to requisite shape and length, fabrication with necessary bolting, metal arc welding conforming to IS 816-1969 & IS 1995 using electrodes of approved make and brand conforming to IS:814-2004, haulage, hoisting and erection all complete. The rate includes the cost of rolled steel section, consumables such as electrodes, gas and fuel charge of all tools and plants and labour required for the work including all incidental charges such as electricity charges, labour insurance charges etc. (P.W.D 2017. (Building). IT No - 2A ; Pg.no - 101) For 2nos. Channels in sides of grating = 2 x 5.0 m @ 16.8 kg / meter = 168.0 kg. @ Rs. 60276 per M.T. = 0 168 x 60276.00	10126.37
2	M.S. works in framed gratings of window etc. made of round or square bars and frame work or M.S. flats (with the bars securely fixed to the flat bar frame) with or without intermediate flat bar stiffener and fixed with necessary screws etc. complete, as directed. (P.W.D 2017. (Building). IT No - 12 ; Pg.no - 104) Total - 4.0 m X 4.0 m @ 35 kg / sqm. = 560.0 kg @ Rs. 6299.00 per qntl. for 5.60 Qntl.-	35274.40
3	Reinforced cement concrete - M - 20 1 Cum. @ Rs. 5837.86	5837.86
4	Steel reinforcement for R.C.C. work @ 1% of RCC volume - 78.5 kg @ Rs. 67081/MT	5265.86
5	Providing anti-corrosive protective coating to inhibit the corrosion to HYSD reinforcements including two coats of anti-corrosive coatings of consumption as per manufacturer's specification, cleaning etc. complete as per the direction of the Engineer-in- Charge. (P.W.D 2018. (Roads). IT No - 16.21 ; Pg.no - 322) Total , 4.0 x 4.0 = 16.0 Sqm. @ Rs. 506.00 per Sqm.	8096.00
	Total - Rs.	64600.49
	Adding 12% GST , Rs. -	7752.06
	Adding 1% Cess over GST added amount , Rs. -	723.53
	Total , Rs. -	73076.07
	Say , Rs. -	73076.00
In words - Rupees Seventy three thousand seventy six only		

11/03/19
(JE/WBD/WAS)

vetted -
WAS
11/3/19

R. L. ...
S.E. / North ...

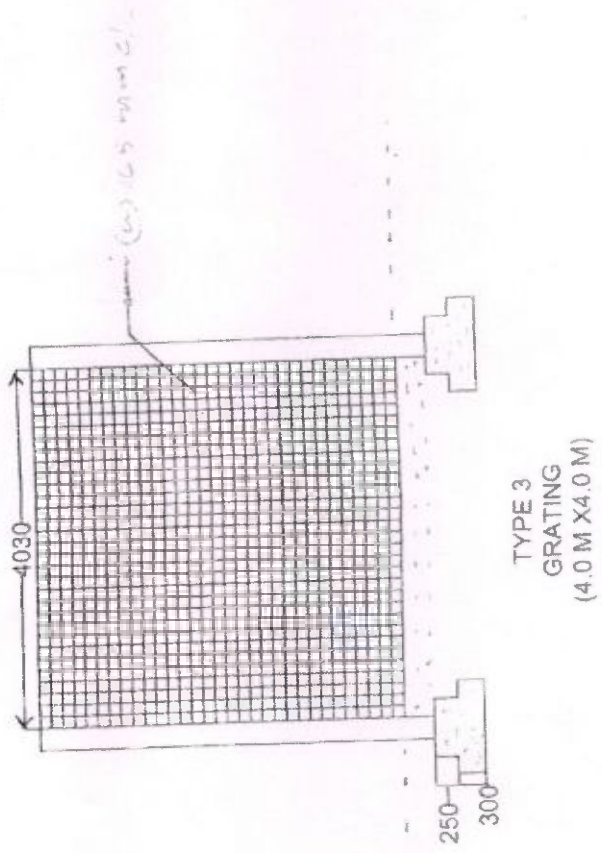
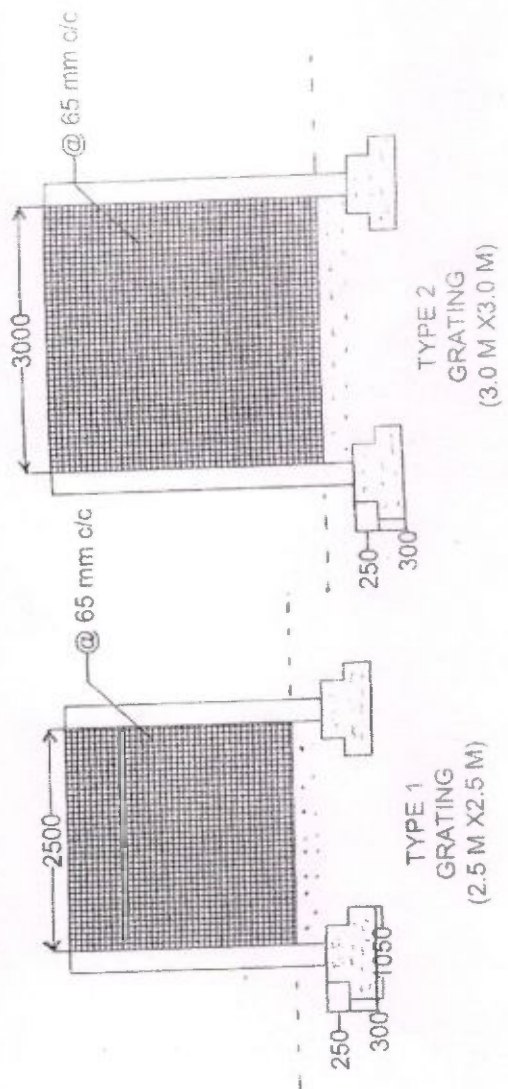



Bansberia Kundw Ghat, Ward No-6.

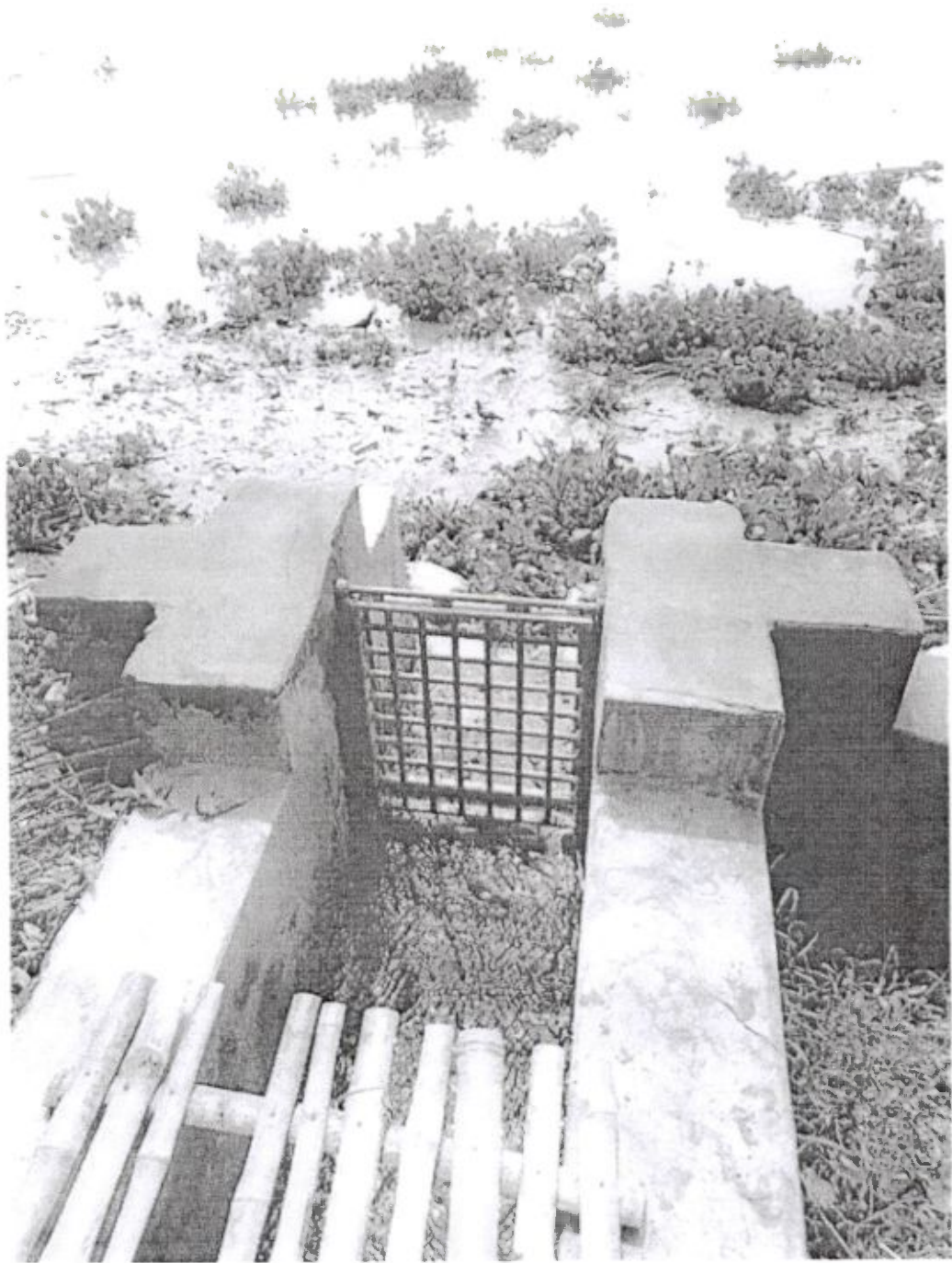

Bansberia Ganesh Ghat, Ward No-6.



Bansberia Ganesht Ghat, Ward No-6.



Bansberia Kundu Ghat, Ward No-6.

Status report for instalation of screener, Haldia Municipality

Sl.No	Total nos. of Screener to be instaled	No.of Screener work started	Nos. of Screener work not yet started	Percentage of work Completed	Time limitt (Construction completion)
1	08	01	07	10%	2 Month

Executive Officer,

Haldia Municipality.

Executive Officer
Haldia Municipality
Purba Medinipur



UD/00/2019/03444
Pr. Secy, UD & MA 19/3/19

Kolkata Metropolitan Development Authority

Memo No : 1758 - NGRBA/SPMG/Ganga Committee - 374/2017(P-1)

Dated : 08.03.2019

From : Project Director, WBSPMG & CEO, KMDA.

To : The Chairman/Chairperson

EE/SUDA
(B.K.Pal)
18/3/19

DD (AD)
Pl.
20-03-19

Baidyabati, Bansberia, Baranagar, Berhampore, Bhadreswar, Bhatpara, Budge Budge, Chakdah, Champdany, Dhulian, Diamond Harbour, Garulia, Gayeshpur, Haldia, Halisahar, Hooghly Chinsurah, Jangipur, Jiaganj-Azimganj, Kalyani, Kamarhati, Kanchrapara, Katwa, Khardah, Konnagar, Krishnanagar, Maheshala, Murshidabad, Nabadwip, Naihati, North Barrackpore, Panihati, Rishra, Santipur, Serampore, Titagarh, Uluberia, UttarparaKotrung,HMC, Chandannagore MC, DurgapurMC, Asansol MC

Ref : Prin. Secy / UD&MA/2019/069(SUDA-50/2016) dated 19.02.19

Sir/Madam,

In reference to the discussion of the meeting held on 16.2.19 with the representatives of the 40 Ganga towns at conference hall of Stadel, Saltlake and communication made by the Principal Secretary, UD&MA, GoWB thereafter regarding some directions given for immediate action on the issue of solid waste management for necessary compliance for abatement to pollution to river Ganga it is expected that all the concerned ULBs have taken necessary initiatives for the said purpose.

With some other directions it has been directed to take required action for screening on all outfalls/channels leading river Ganga at interval with reasonable distance away from culminating points to restrict /arrest Solid waste from flowing directly or indirectly to the river. Necessary action is expected to be taken by the concerned ULBs. You are requested to send requirement of fund along with the plan of action for screening on all the outfalls following the model estimate enclosed herewith for submission of the same to WBPCB for allocation of fund for the said purpose.

For the IEC activities by displaying placards, festoons and other form of public awareness with anti littering message at all the ghats and vulnerable points required fund may be placed out of the SPMG fund meant for the IEC and Public outreach activities for the purpose of mass awareness and information on submission of requisition to PD, SPMG.

Immediate action required to be taken for the compliance of the order of the Hon'ble NGT to avoid any adverse order in this regard for non compliance.

Encl : model estimate for screening

Project Director, WBSPMG & CEO, KMDA

Memo No : 1758/1(2)-NGRBA/SPMG/Ganga Committee-374/2017(P-1) Date : March 11, 2019

Copy forwarded for information and necessary action to

1. Director ,SUDA
2. PS to Principal Secretary , UD&MA

JSL(SM)
18/03/2019
Project Director, WBSPMG & CEO, KMDA

Rate Analysis of Grating 2.5 m X 2.5 m (Type 1)

Sl no.	Particulars of Item	Amount (Rs.)
1	M.S. structural works in columns, beams etc. with simple rolled structural members (e.g. joists, angle, channel sections conforming to IS: 226, IS: 808 & SP (6)- 1964 connected to one another with bracket, gussets, cleats as per design, direction of Engineer-in-charge complete including cutting to requisite shape and length, fabrication with necessary bolting, metal arc welding conforming to IS: 816- 1969 & IS: 1995 using electrodes of approved make and brand conforming to IS:814- 2004, haulage, hoisting and erection all complete. The rate includes the cost of rolled steel section, consumables such as electrodes, gas and hire charge of all tools and plants and labour required for the work including all incidental chages such as electricity charges, labour insurance charges etc. (P.W.D 2017. (Building). IT No - 2A ; Pg.no - 101) For 2nos. Channels in sides of grating = 2 x 3.5m @16.8 kg / meter = 117.6 kg. @ Rs. 60276 per M.T. = 0.1176 x 60276 = Rs. 7088.46	7088.46
2	M.S. works in framed gratings of window etc.made of round or square bars and frame work or M.S. flats (with the bars securely fixed to the flat bar frame) with or without intermediate flat bar stiffener and fixed with necessary screws etc. complete, as directed. (P.W.D 2017. (Building). IT No - 12 ; Pg.no - 104) Total - 2.5m X 2.5m @ 35 kg / sqm. = 218.75 kg @ Rs. 6299.00 per qntl. for 2.1875 Qntl.-	13779.06
3	Reinforced cement concrete - M - 20 1 Cum. @ Rs. 5837.86	5837.86
4	Steel reinforcement for R.C.C. work @ 1% of RCC volume - 78.5 kg @ Rs. 67081/MT	5265.86
5	Providing anti-corrosive protective coating to inhibit the corrosion to HYSD reinforcements including two coats of anti-corrosive coatings of consumption as per manufacturer's specification, cleaning etc. complete as per the direction of the Engineer-in- Charge. (P.W.D 2018. (Roads). IT No - 16.21 ; Pg.no - 322) Total , 2.5 x 2.5 = 6.25 Sqm. @ Rs. 506.00 per Sqm.	3162.5
	Total - Rs.	35133.74
	Adding 12% GST , Rs. -	4216.05
	Adding 1% Cess over GST added amount , Rs. -	393.50
	Total , Rs. -	39743.29
	Say , Rs. -	39743.00
In words - Rupees thirty nine thousand seven hundred forty three only		

S
11/03/19
(JE/W&D/W&S)

veted.
W&D
11/3/19

Rate Analysis of Grating 3.0 m X 3.0 m (Type 2)

Sl no.	Particulars of Item	Amount (Rs.)
1	M.S. structural works in columns, beams etc. with simple rolled structural members (e.g. joists, angle, channel sections conforming to IS: 226, IS: 808 & SP (6)- 1964 connected to one another with bracket, gussets, cleats as per design, direction of Engineer-in-charge complete including cutting to requisite shape and length, fabrication with necessary bolting, metal arc welding conforming to IS: 816- 1969 & IS: 1995 using electrodes of approved make and brand conforming to IS:814- 2004, haulage, hoisting and erection all complete. The rate includes the cost of rolled steel section, consumables such as electrodes, gas and hire charge of all tools and plants and labour required for the work including all incidental chages such as electricity charges, labour insurance charges etc. (P.W.D 2017. (Building). IT No - 2A ; Pg.no - 101) For 2nos. Channels in sides of grating = 2 x 4.0 m @16.8 kg / meter = 134.4 kg. @ Rs. 60276 per M.T. = 0.1344 x 60276	8101.09
2	M.S. works in framed gratings of window etc.made of round or square bars and frame work or M.S. flats (with the bars securely fixed to the flat bar frame) with or without intermediate flat bar stiffener and fixed with necessary screws etc. complete, as directed. (P.W.D 2017. (Building). IT No - 12 ; Pg.no - 104) Total - 3.0 m X 3.0 m @ 35 kg / sqm. = 315.0 kg @ Rs. 6299.00 per qntl. for 3.15 Qntl.-	19841.85
3	Reinforced cement concrete - M - 20 1 Cum. @ Rs. 5837.86	5837.86
4	Steel reinforcement for R.C.C. work @ 1% of RCC volume - 78.5 kg @ Rs. 67081/MT	5265.86
5	Providing anti-corrosive protective coating to inhibit the corrosion to HYSD reinforcements including two coats of anti-corrosive coatings of consumption as per manufacturer's specification, cleaning etc. complete as per the direction of the Engineer-in- Charge. (P.W.D 2018. (Roads). IT No - 16.21 ; Pg.no - 322) Total , 3.0 x 3.0 = 9.0 Sqm. @ Rs. 506.00 per Sqm.	4554
	Total - Rs.	43600.66
	Adding 12% GST , Rs. -	5232.08
	Adding 1% Cess over GST added amount , Rs. -	488.33
	Total , Rs. -	49321.07
	Say , Rs. -	49321.00
In words - Rupees forty nine thousand three hundred twenty one only		

[Signature]
11/03/19
(JE/WBD/GAP)

[Signature]
11/3/19

Rate Analysis of Grating 4.0 m X 4.0 m (Type 3)

Sl no.	Particulars of Item	Amount (Rs.)
1	M.S. structural works in columns, beams etc. with simple rolled structural members (e.g. joists, angle, channel sections conforming to IS: 226, IS: 808 & SP (6)- 1964 connected to one another with bracket, gussets, cleats as per design, direction of Engineer-in-charge complete including cutting to requisite shape and length, fabrication with necessary bolting, metal arc welding conforming to IS: 816- 1969 & IS: 1995 using electrodes of approved make and brand conforming to IS:814- 2004, haulage, hoisting and erection all complete. The rate includes the cost of rolled steel section, consumables such as electrodes, gas and hire charge of all tools and plants and labour required for the work including all incidental chages such as electricity charges, labour insurance charges etc. (P.W.D 2017. (Building). IT No - 2A ; Pg.no - 101) For 2nos. Channels in sides of grating = 2 x 5.0 m @16.8 kg / meter = 168.0 kg. @ Rs. 60276 per M.T. = 0.168 x 60276.00	10126.37
2	M.S. works in framed gratings of window etc.made of round or square bars and frame work or M.S. flats (with the bars securely fixed to the flat bar frame) with or without intermediate flat bar stiffener and fixed with necessary screws etc. complete, as directed. (P.W.D 2017. (Building). IT No - 12 ; Pg.no - 104) Total - 4.0 m X 4.0 m @ 35 kg / sqm. = 560.0 kg @ Rs. 6299.00 per qntl. for 5.60 Qntl.-	35274.40
3	Reinforced cement concrete - M - 20 1 Cum. @ Rs. 5837.86	5837.86
4	Steel reinforcement for R.C.C. work @ 1% of RCC volume - 78.5 kg @ Rs. 67081/MT	5265.86
5	Providing anti-corrosive protective coating to inhibit the corrosion to HYSD reinforcements including two coats of anti-corrosive coatings of consumption as per manufacturer's specification, cleaning etc. complete as per the direction of the Engineer-in- Charge. (P.W.D 2018. (Roads). IT No - 16.21 ; Pg.no - 322) Total , 4.0 x 4.0 = 16.0 Sqm. @ Rs. 506.00 per Sqm.	8096.00
	Total - Rs.	64600.49
	Adding 12% GST , Rs. -	7752.06
	Adding 1% Cess over GST added amount , Rs. -	723.53
	Total , Rs. -	73076.07
	Say , Rs. -	73076.00
In words - Rupees Seventy three thousand seventy six only		

(JE/WBD/WAS)
11/03/19

Vatted -
WAS
11/3/19

R. Rom. 11/3/19
JTE / North Circle / CIAP

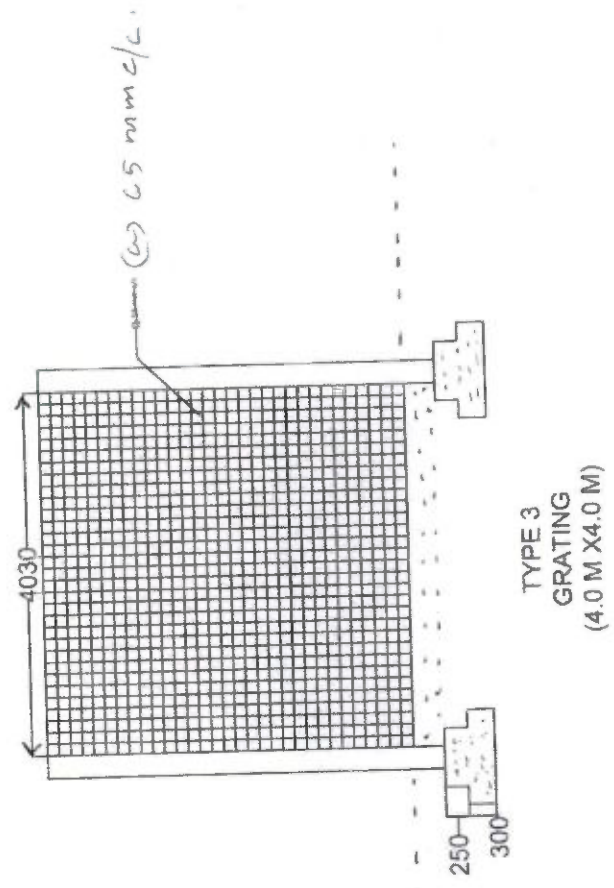
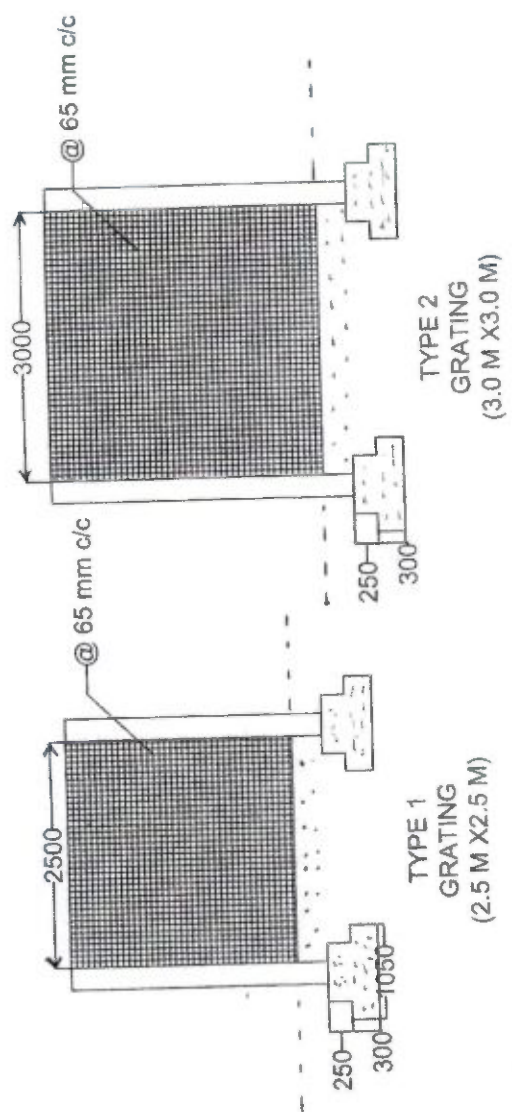



UD/00/2019/03444
Pr. Secy, UD & MA 19/3/19

Kolkata Metropolitan Development Authority

Memo No : 1758 - NGRBA/SPMG/Ganga Committee - 374/2017(P-1)

Dated : 08.03.2019

From : Project Director, WBSPMG & CEO, KMDA.

To : The Chairman/Chairperson

Baidyabati, Bansberia, Baranagar, Berhampore, Bhadreswar, Bhatpara, Budge Budge, Chakdah, Champdany, Dhulian, Diamond Harbour, Garulia, Gayeshpur, Haldia, Halisahar, Hooghly Chinsurah, Jangipur, Jiaganj-Azinganj, Kalyani, Kamarhati, Kanchrapara, Katwa, Khardah, Konnagar, Krishnanagar, Maheshtala, Murshidabad, Nabadwip, Naihati, North Barrackpore, Panihati, Rishra, Santipur, Serampore, Titagarh, Uluberia, UttarparaKotrung, HMC, Chandannagore MC, DurgapurMC, Asansol MC

Ref : Prin. Secy / UD&MA/2019/069(SUDA-50/2016) dated 19.02.19

Sir/Madam,

In reference to the discussion of the meeting held on 16.2.19 with the representatives of the 40 Ganga towns at conference hall of Stadel, Saltlake and communication made by the Principal Secretary, UD&MA, GoWB thereafter regarding some directions given for immediate action on the issue of solid waste management for necessary compliance for abatement to pollution to river Ganga it is expected that all the concerned ULBs have taken necessary initiatives for the said purpose.

With some other directions it has been directed to take required action for screening on all outfalls/channels leading river Ganga at interval with reasonable distance away from culminating points to restrict /arrest Solid waste from flowing directly or indirectly to the river. Necessary action is expected to be taken by the concerned ULBs. You are requested to send requirement of fund along with the plan of action for screening on all the outfalls following the model estimate enclosed herewith for submission of the same to WBPCB for allocation of fund for the said purpose.

For the IEC activities by displaying placards, festoons and other form of public awareness with anti littering message at all the ghats and vulnerable points required fund may be placed out of the SPMG fund meant for the IEC and Public outreach activities for the purpose of mass awareness and information on submission of requisition to PD, SPMG.

Immediate action required to be taken for the compliance of the order of the Hon'ble NGT to avoid any adverse order in this regard for non compliance.

Encl : model estimate for screening

Project Director, WBSPMG & CEO, KMDA

Memo No : 1758/1(2)-NGRBA/SPMG/Ganga Committee-374/2017(P-1) Date : March 11, 2019

Copy forwarded for information and necessary action to

1. Director, SUDA
2. PS to Principal Secretary, UD&MA

JS(SM)
18/III/2019
Project Director, WBSPMG & CEO, KMDA

EE/SUBA (B.K. Paul)
DD(AD)
Pl.
20-03-19

Rate Analysis of Grating 2.5 m X 2.5 m (Type 1)

Sl no.	Particulars of item	Amount (Rs.)
1	M.S. structural works in columns, beams etc. with simple rolled structural members (e.g. joists, angle, channel sections conforming to IS: 226, IS: 808 & SP (6)- 1964 connected to one another with bracket, gussets, cleats as per design, direction of Engineer-in-charge complete including cutting to requisite shape and length, fabrication with necessary bolting, metal arc welding conforming to IS: 816- 1969 & IS: 1995 using electrodes of approved make and brand conforming to IS:814- 2004, haulage, hoisting and erection all complete. The rate includes the cost of rolled steel section, consumables such as electrodes, gas and hire charge of all tools and plants and labour required for the work including all incidental chages such as electricity charges, labour insurance charges etc. (P.W.D 2017. (Building). IT No - 2A ; Pg.no - 101) For 2nos. Channels in sides of grating = 2 x 3.5m @16.8 kg / meter = 117.6 kg. @ Rs. 60276 per M.T. = 0.1176 x 60276 = Rs. 7088.46	7088.46
2	M.S. works in framed gratings of window etc.made of round or square bars and frame work or M.S. flats (with the bars securely fixed to the flat bar frame) with or without intermediate flat bar stiffener and fixed with necessary screws etc. complete, as directed. (P.W.D 2017. (Building). IT No - 12 ; Pg.no - 104) Total - 2.5m X 2.5m @ 35 kg / sqm. = 218.75 kg @ Rs. 6299.00 per qntl. for 2.1875 Qntl.-	13779.06
3	Reinforced cement concrete - M - 20 1 Cum. @ Rs. 5837.86	5837.86
4	Steel reinforcement for R.C.C. work @ 1% of RCC volume - 78.5 kg @ Rs. 67081/MT	5265.86
5	Providing anti-corrosive protective coating to inhibit the corrosion to HYSD reinforcements including two coats of anti-corrosive coatings of consumption as per manufacturer's specification, cleaning etc. complete as per the direction of the Engineer-in- Charge. (P.W.D 2018. (Roads). IT No - 16.21 ; Pg.no - 322) Total , 2.5 x 2.5 = 6.25 Sqm. @ Rs. 506.00 per Sqm.	3162.5
	Total - Rs.	35133.74
	Adding 12% GST , Rs. -	4216.05
	Adding 1% Cess over GST added amount , Rs. -	393.50
	Total , Rs. -	39743.29
	Say , Rs. -	39743.00
In words - Rupees thirty nine thousand seven hundred forty three only		

S
11/03/19
(JE/WBD/WAS)

veted.
WBD
11/3/19

Rate Analysis of Grating 3.0 m X 3.0 m (Type 2)

Sl no.	Particulars of Item	Amount (Rs.)
1	M.S. structural works in columns, beams etc. with simple rolled structural members (e.g. joists, angle, channel sections conforming to IS: 226, IS: 808 & SP (6)- 1964 connected to one another with bracket, gussets, cleats as per design, direction of Engineer-in-charge complete including cutting to requisite shape and length, fabrication with necessary bolting, metal arc welding conforming to IS: 816- 1969 & IS: 1995 using electrodes of approved make and brand conforming to IS:814- 2004, haulage, hoisting and erection all complete. The rate includes the cost of rolled steel section, consumables such as electrodes, gas and hire charge of all tools and plants and labour required for the work including all incidental chages such as electricity charges, labour insurance charges etc. (P.W.D 2017. (Building). IT No - 2A ; Pg.no - 101) For 2nos. Channels in sides of grating = 2 x 4.0 m @16.8 kg / meter = 134.4 kg. @ Rs. 60276 per M.T. = 0.1344 x 60276	8101.09
2	M.S. works in framed gratings of window etc.made of round or square bars and frame work or M.S. flats (with the bars securely fixed to the flat bar frame) with or without intermediate flat bar stiffener and fixed with necessary screws etc. complete, as directed. (P.W.D 2017. (Building). IT No - 12 ; Pg.no - 104) Total - 3.0 m X 3.0 m @ 35 kg / sqm. = 315.0 kg @ Rs. 6299.00 per qntl. for 3.15 Qntl.-	19841.85
3	Reinforced cement concrete - M - 20 1 Cum. @ Rs. 5837.86	5837.86
4	Steel reinforcement for R.C.C. work @ 1% of RCC volume - 78.5 kg @ Rs. 67081/MT	5265.86
5	Providing anti-corrosive protective coating to inhibit the corrosion to HYSD reinforcements including two coats of anti-corrosive coatings of consumption as per manufacturer's specification, cleaning etc. complete as per the direction of the Engineer-in- Charge. (P.W.D 2018. (Roads). IT No - 16.21 ; Pg.no - 322) Total , 3.0 x 3.0 = 9.0 Sqm. @ Rs. 506.00 per Sqm.	4554
	Total - Rs.	43600.66
	Adding 12% GST , Rs. -	5232.08
	Adding 1% Cess over GST added amount , Rs. -	488.33
	Total , Rs. -	49321.07
	Say , Rs. -	49321.00
In words - Rupees forty nine thousand three hundred twenty one only		

[Signature]
11/03/19
(JE/WBD/GAP)

[Signature]
11/3/19

Rate Analysis of Grating 4.0 m X 4.0 m (Type 3)

Sl no.	Particulars of Item	Amount (Rs.)
1	M.S. structural works in columns, beams etc. with simple rolled structural members (e.g. joists, angle, channel sections conforming to IS: 226, IS: 808 & SP (6)- 1964 connected to one another with bracket, gussets, cleats as per design, direction of Engineer-in-charge complete including cutting to requisite shape and length, fabrication with necessary bolting, metal arc welding conforming to IS: 816- 1969 & IS: 1995 using electrodes of approved make and brand conforming to IS:814- 2004, haulage, hoisting and erection all complete. The rate includes the cost of rolled steel section, consumables such as electrodes, gas and hire charge of all tools and plants and labour required for the work including all incidental chages such as electricity charges, labour insurance charges etc. (P.W.D 2017. (Building). IT No - 2A ; Pg.no - 101) For 2nos. Channels in sides of grating = 2 x 5.0 m @16.8 kg / meter = 168.0 kg. @ Rs. 60276 per M.T. = 0.168 x 60276.00	10126.37
2	M.S. works in framed gratings of window etc.made of round or square bars and frame work or M.S. flats (with the bars securely fixed to the flat bar frame) with or without intermediate flat bar stiffener and fixed with necessary screws etc. complete, as directed. (P.W.D 2017. (Building). IT No - 12 ; Pg.no - 104) Total - 4.0 m X 4.0 m @ 35 kg / sqm. = 560.0 kg @ Rs. 6299.00 per qntl. for 5.60 Qntl.-	35274.40
3	Reinforced cement concrete - M - 20 1 Cum. @ Rs. 5837.86	5837.86
4	Steel reinforcement for R.C.C. work @ 1% of RCC volume - 78.5 kg @ Rs. 67081/MT	5265.86
5	Providing anti-corrosive protective coating to inhibit the corrosion to HYSD reinforcements including two coats of anti-corrosive coatings of consumption as per manufacturer's specification, cleaning etc. complete as per the direction of the Engineer-in- Charge. (P.W.D 2018. (Roads). IT No - 16.21 ; Pg.no - 322) Total , 4.0 x 4.0 = 16.0 Sqm. @ Rs. 506.00 per Sqm.	8096.00
	Total - Rs.	64600.49
	Adding 12% GST , Rs. -	7752.06
	Adding 1% Cess over GST added amount , Rs. -	723.53
	Total , Rs. -	73076.07
	Say , Rs. -	73076.00
In words - Rupees Seventy three thousand seventy six only		

R
11/03/19
(JE/WBD/WAS)

vatted -
WBD
11/3/19

R. Ram. 11/3/19
JEE North Circle/CI AP

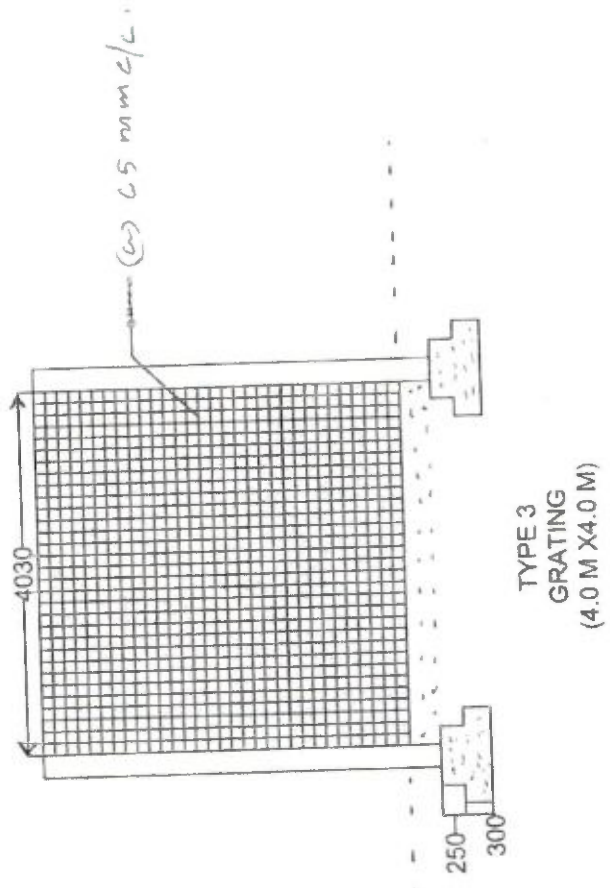
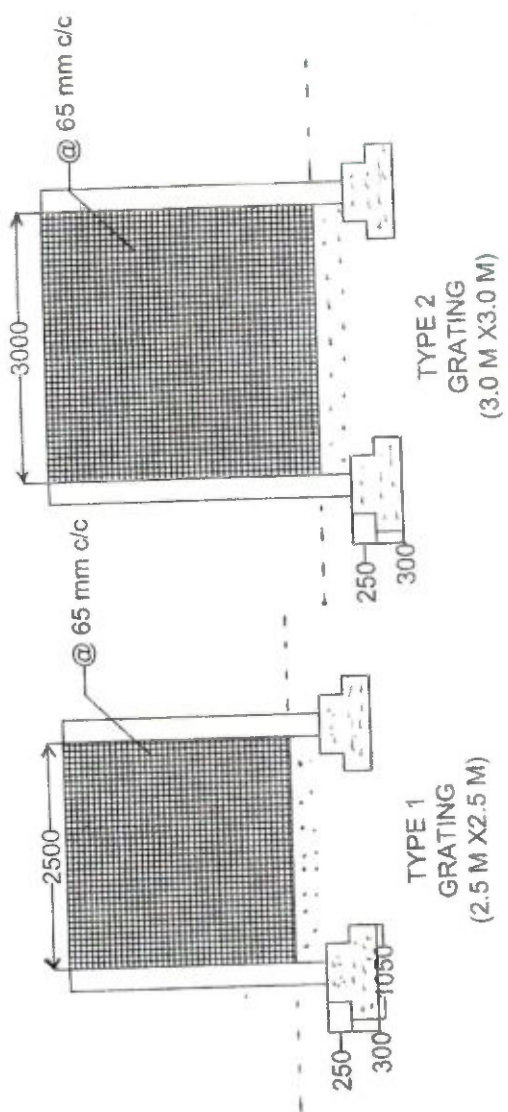



UD/00/2019/03444
Pr. Secy, UD & MA 19/3/19

Kolkata Metropolitan Development Authority

Memo No : 1758 - NGRBA/SPMG/Ganga Committee - 374/2017(P-1)

Dated : 08.03.2019

From : Project Director, WBSPMG & CEO, KMDA.

To : The Chairman/Chairperson

Baidyabati, Bansberia, Baranagar, Berhampore, Bhadreswar, Bhatpara, Budge Budge, Chakdah, Champdany, Dhulian, Diamond Harbour, Garulia, Gayeshpur, Haldia, Halisahar, Hooghly Chinsurah, Jangipur, Jiaganj-Azinganj, Kalyani, Kamarhati, Kanchrapara, Katwa, Khardah, Korunagar, Krishnanagar, Maheshala, Murshidabad, Nabadwip, Naihati, North Barrackpore, Panihati, Rishra, Santipur, Serampore, Titagarh, Uluberia, UttarparaKotrung, HMC, Chandannagore MC, DurgapurMC, Asansol MC

Ref : Prin. Secy / UD&MA/2019/069(SUDA-50/2016) dated 19.02.19

Sir/Madam,

In reference to the discussion of the meeting held on 16.2.19 with the representatives of the 40 Ganga towns at conference hall of Stadel, Saltlake and communication made by the Principal Secretary, UD&MA, GoWB thereafter regarding some directions given for immediate action on the issue of solid waste management for necessary compliance for abatement to pollution to river Ganga it is expected that all the concerned ULBs have taken necessary initiatives for the said purpose.

With some other directions it has been directed to take required action for screening on all outfalls/channels leading river Ganga at interval with reasonable distance away from culminating points to restrict/arrest Solid waste from flowing directly or indirectly to the river. Necessary action is expected to be taken by the concerned ULBs. You are required to send requirement of fund along with the plan of action for screening on all the outfalls following the model estimate enclosed herewith for submission of the same to WBPCB for allocation of fund for the said purpose.

For the IEC activities by displaying placards, festoons and other form of public awareness with anti littering message at all the ghats and vulnerable points required fund may be placed out of the SPMG fund meant for the IEC and Public outreach activities for the purpose of mass awareness and information on submission of requisition to PD, SPMG.

Immediate action required to be taken for the compliance of the order of the Hon'ble NGT to avoid any adverse order in this regard for non compliance.

Encl : model estimate for screening

Project Director, WBSPMG & CEO, KMDA

Memo No : 1758/1(2)-NGRBA/SPMG/Ganga Committee-374/2017(P-1) Date : March 11, 2019
Copy forwarded for information and necessary action to

1. Director, SUDA
2. PS to Principal Secretary, UD&MA

JSS(SM)
18/III/2019
Project Director, WBSPMG & CEO, KMDA

EE/SUBA (B.K. Paul)
DD(AD)
Pl.
20-03-19

Rate Analysis of Grating 2.5 m X 2.5 m (Type 1)

Sl no.	Particulars of Item	Amount (Rs.)
1	M.S. structural works in columns, beams etc. with simple rolled structural members (e.g. joists, angle, channel sections conforming to IS: 226, IS: 808 & SP (6)- 1964 connected to one another with bracket, gussets, cleats as per design, direction of Engineer-in-charge complete including cutting to requisite shape and length, fabrication with necessary bolting, metal arc welding conforming to IS: 816- 1969 & IS: 1995 using electrodes of approved make and brand conforming to IS:814- 2004, haulage, hoisting and erection all complete. The rate includes the cost of rolled steel section, consumables such as electrodes, gas and hire charge of all tools and plants and labour required for the work including all incidental chages such as electricity charges, labour insurance charges etc. (P.W.D 2017. (Building). IT No - 2A ; Pg.no - 101) For 2nos. Channels in sides of grating = 2 x 3.5m @16.8 kg / meter = 117.6 kg. @ Rs. 60276 per M.T. = 0.1176 x 60276 = Rs. 7088.46	7088.46
2	M.S. works in framed gratings of window etc.made of round or square bars and frame work or M.S. flats (with the bars securely fixed to the flat bar frame) with or without intermediate flat bar stiffener and fixed with necessary screws etc. complete, as directed. (P.W.D 2017. (Building). IT No - 12 ; Pg.no - 104) Total - 2.5m X 2.5m @ 35 kg / sqm. = 218.75 kg @ Rs. 6299.00 per qntl. for 2.1875 Qntl.-	13779.06
3	Reinforced cement concrete - M - 20 1 Cum. @ Rs. 5837.86	5837.86
4	Steel reinforcement for R.C.C. work @ 1% of RCC volume - 78.5 kg @ Rs. 67081/MT	5265.86
5	Providing anti-corrosive protective coating to inhibit the corrosion to HYSD reinforcements including two coats of anti-corrosive coatings of consumption as per manufacturer's specification, cleaning etc. complete as per the direction of the Engineer-in- Charge. (P.W.D 2018. (Roads). IT No - 16.21 ; Pg.no - 322) Total , 2.5 x 2.5 = 6.25 Sqm. @ Rs. 506.00 per Sqm.	3162.5
	Total - Rs.	35133.74
	Adding 12% GST , Rs. -	4216.05
	Adding 1% Cess over GST added amount , Rs. -	393.50
	Total , Rs. -	39743.29
	Say , Rs. -	39743.00
In words - Rupees thirty nine thousand seven hundred forty three only		

S
11/03/19
(JE/WBD/WAS)

vetter.
W...
11/3/19

Rate Analysis of Grating 3.0 m X 3.0 m (Type 2)

Sl no.	Particulars of Item	Amount (Rs.)
1	M.S. structural works in columns, beams etc. with simple rolled structural members (e.g. joists, angle, channel sections conforming to IS: 226, IS: 808 & SP (6)- 1964 connected to one another with bracket, gussets, cleats as per design, direction of Engineer-in-charge complete including cutting to requisite shape and length, fabrication with necessary bolting, metal arc welding conforming to IS: 816- 1969 & IS: 1995 using electrodes of approved make and brand conforming to IS:814- 2004, haulage, hoisting and erection all complete. The rate includes the cost of rolled steel section, consumables such as electrodes, gas and hire charge of all tools and plants and labour required for the work including all incidental chages such as electricity charges, labour insurance charges etc. (P.W.D 2017. (Building). IT No - 2A ; Pg.no - 101) For 2nos. Channels in sides of grating = 2 x 4.0 m @16.8 kg / meter = 134.4 kg. @ Rs. 60276 per M.T. = 0.1344 x 60276	8101.09
2	M.S. works in framed gratings of window etc.made of round or square bars and frame work or M.S. flats (with the bars securely fixed to the flat bar frame) with or without intermediate flat bar stiffener and fixed with necessary screws etc. complete, as directed. (P.W.D 2017. (Building). IT No - 12 ; Pg.no - 104) Total - 3.0 m X 3.0 m @ 35 kg / sqm. = 315.0 kg @ Rs. 6299.00 per qntl. for 3.15 Qntl.-	19841.85
3	Reinforced cement concrete - M - 20 1 Cum. @ Rs. 5837.86	5837.86
4	Steel reinforcement for R.C.C. work @ 1% of RCC volume - 78.5 kg @ Rs. 67081/MT	5265.86
5	Providing anti-corrosive protective coating to inhibit the corrosion to HYSD reinforcements including two coats of anti-corrosive coatings of consumption as per manufacturer's specification, cleaning etc. complete as per the direction of the Engineer-in- Charge. (P.W.D 2018. (Roads). IT No - 16.21 ; Pg.no - 322) Total , 3.0 x 3.0 = 9.0 Sqm. @ Rs. 506.00 per Sqm.	4554
	Total - Rs.	43600.66
	Adding 12% GST , Rs. -	5232.08
	Adding 1% Cess over GST added amount , Rs. -	488.33
	Total , Rs. -	49321.07
	Say , Rs. -	49321.00
In words - Rupees forty nine thousand three hundred twenty one only		

[Signature]
11/03/19
(JE/WBD/GAP)

[Signature]
11/3/19

Rate Analysis of Grating 4.0 m X 4.0 m (Type 3)

Sl no.	Particulars of Item	Amount (Rs.)
1	M.S. structural works in columns, beams etc. with simple rolled structural members (e.g. joists, angle, channel sections conforming to IS: 226, IS: 808 & SP (6)- 1964 connected to one another with bracket, gussets, cleats as per design, direction of Engineer-in-charge complete including cutting to requisite shape and length, fabrication with necessary bolting, metal arc welding conforming to IS: 816- 1969 & IS: 1995 using electrodes of approved make and brand conforming to IS:814- 2004, haulage, hoisting and erection all complete. The rate includes the cost of rolled steel section, consumables such as electrodes, gas and hire charge of all tools and plants and labour required for the work including all incidental chages such as electricity charges, labour insurance charges etc. (P.W.D 2017. (Building). IT No - 2A ; Pg.no - 101) For 2nos. Channels in sides of grating = 2 x 5.0 m @16.8 kg / meter = 168.0 kg. @ Rs. 60276 per M.T. = 0.168 x 60276.00	10126.37
2	M.S. works in framed gratings of window etc.made of round or square bars and frame work or M.S. flats (with the bars securely fixed to the flat bar frame) with or without intermediate flat bar stiffener and fixed with necessary screws etc. complete, as directed. (P.W.D 2017. (Building). IT No - 12 ; Pg.no - 104) Total - 4.0 m X 4.0 m @ 35 kg / sqm. = 560.0 kg @ Rs. 6299.00 per qntl. for 5.60 Qntl.-	35274.40
3	Reinforced cement concrete - M - 20 1 Cum. @ Rs. 5837.86	5837.86
4	Steel reinforcement for R.C.C. work @ 1% of RCC volume - 78.5 kg @ Rs. 67081/MT	5265.86
5	Providing anti-corrosive protective coating to inhibit the corrosion to HYSD reinforcements including two coats of anti-corrosive coatings of consumption as per manufacturer's specification, cleaning etc. complete as per the direction of the Engineer-in- Charge. (P.W.D 2018. (Roads). IT No - 16.21 ; Pg.no - 322) Total , 4.0 x 4.0 = 16.0 Sqm. @ Rs. 506.00 per Sqm.	8096.00
	Total - Rs.	64600.49
	Adding 12% GST , Rs. -	7752.06
	Adding 1% Cess over GST added amount , Rs. -	723.53
	Total , Rs. -	73076.07
	Say , Rs. -	73076.00
In words - Rupees Seventy three thousand seventy six only		

11/03/19
(JE/WBD/WAS)

Vittal -
WBD
11/3/19

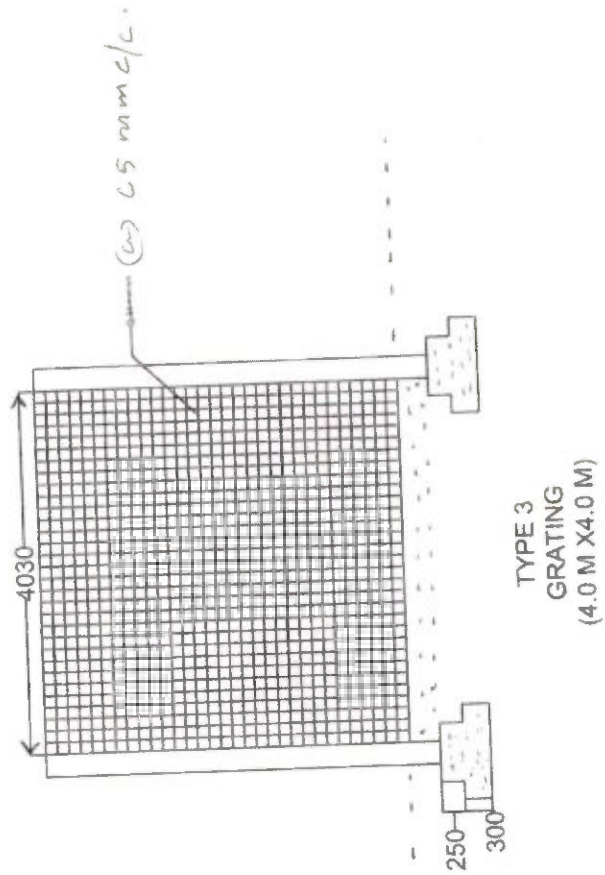
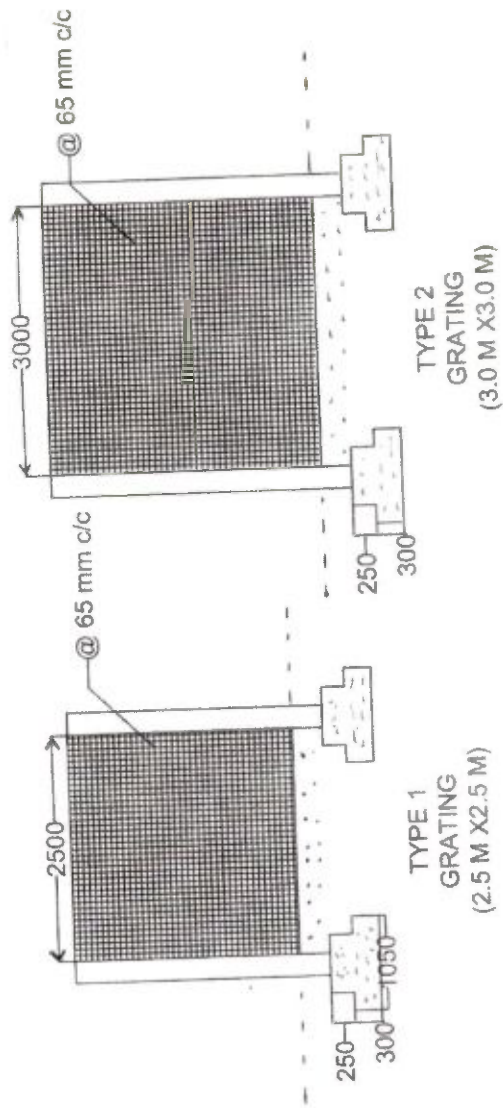

R. Rev. 11/3/19
 JTE / North Circle / C. AP



mailed

SUDA

রাজ্য নগর উন্নয়ন সংস্থা

STATE URBAN DEVELOPMENT AGENCY

“ইলগাস ভবন”, এইচ-সি ব্লক, সেক্টর-৩, বিধাননগর, কলকাতা-৭০০ ১০৬, পশ্চিমবঙ্গ

“ILGUS BHAVAN”, H-C Block, Sector - III, Bidhannagar, Kolkata - 700 106, West Bengal

ক্রমিক নং SUDA - 229/2018/7809

তারিখ 05/12/19

From: Director, SUDA.

To: The Executive Officer,
Garulia Municipality,
North 24-Parganas.

Sub: Requirement of fund for screening across channel/drain discharging to river Ganga within Garulia Municipality.

Ref: Your Memo no: 449 dated: 31.10.19

Sir,

In reference to the above this is to remind you that in the meeting, on Municipal Solid Waste Management and Monitoring of Ganga Towns, held on 10th July at SUDA Conference Hall, a decision has been taken that work related to screening on small nullah/drain up to the size of 1.2m x 1.2m to be executed by the Municipal Authority of its own. Reimbursement of funds for installation of screens above 1.2m x 1.2m may be claimed with work done estimate duly vetted by the concerned Executive Engineer of KMDA/M.E.Dte. The copy of the said minutes is being attached herewith for your ready reference please.

The rate analysis submitted by your good office are for the screens having size 1.2m x 1.2m, for each and every location. You are hereby again requested to execute the work immediately if not done till date as it relates to direction of Hon'ble National Green Tribunal.

Thanking you,

Yours faithfully,

Director, SUDA

Encl: As stated above

দূরভাষ : ২৩৫৮ ৬৪০৩ / ৫৭৬৭, ফ্যাক্স : ২৩৫৮ ৫৮০০

Tel : 2358 6403/5767, Fax : 2358 5800, E-mail : wbsudadir@gmail.com

Account Section : 2358 6408

Minutes of the Meeting on Municipal Solid Waste Management and Monitoring of Ganga Towns

Date: 10th July 2019

Time: 12.00

Venue: SUDA Conference Hall

The Director, SUDA chaired the meeting.

The Deputy Director, SUDA briefly explained the objective of the meeting and requested the representatives of the concerned municipalities to briefly explain the action already taken by them in connection with solid waste management in municipal towns. Directives of the NGT State Committee accorded in the last meeting dated 26.06.2019 were explained to the participants. Status on different milestones required to be achieved for effective waste management in cities was updated.

After detailed discussions following decisions were taken:

1. The GVPs and Animal Pens still exist in different municipal areas should be removed immediately. The concerned ULBs will submit a compliance report by 25.7.19.
2. The drains where screens are not yet installed should immediately be identified and necessary installation work should be taken up.
3. The ghats where IEC materials are not displayed and bins are not provided should immediately be identified and necessary actions should be taken up.
4. The drawing/design and estimates for the screening on drain as provided by SUDA/KMDA should ideally be followed. If required, considering the site condition
5. design and estimate may be customized by the AE/SAE of the Municipality subject to getting it vetted by AE/EE of KMDA or ME Dte.
6. It is understood that work related to screening on small nullah/drain has been executed by the Municipal Authority of its own. In case of requirement of funds for installation of screens above 1.2 m X 1.2 m reimbursement of funds may be claimed with work done estimates duly vetted by the concerned Executive Engineer of KMDA/ME Dte.
7. The ULBs will submit a list of such drain/canal lying within the locality of the municipal area but maintained by other government department/ authorities.
8. It was explained that integrated solid waste management plan is required to be taken up in the Ganga towns instead of abrupt planning for procurement of vehicles or installation of waste processing plant. The Nodal Officer SWM in Municipality will explain the concept along with

different provisions of SWM Rule 2016 before SWM Task Force members for better understanding of the issues.

9. For effective SWM planning in towns, SUDA is in a process to empanel Micro Planning Organizations. ULBs may send proposal to SUDA for providing consultancy and capacity building support so that integrated planning process for solid waste management can be undertaken in the respective town.
10. The ULBs will take initiative for searching of suitable land for establishment of different SWM facilities. The project can also be planned on cluster basis clubbing few adjoining municipalities to overcome land constraints.
11. The ULBs will submit details of the land procurement or inter departmental land transfer proposals to SUDA that are already under process immediately.

Finally the Joint Secretary of UD & MA Dept. And the additional Mission Director, SBM reminded the house that compliance the SWM Rule-2016 should mandatorily be made in time as the SWM activities are under active surveillance of hon'bleNGT.

Meeting ended with thanks to and from the chair.

Director, SUDA

রাজ্য নগর উন্নয়ন সংস্থা

STATE URBAN DEVELOPMENT AGENCY

“ইলগাস ভবন”, এইচ-সি ব্লক, সেক্টর-৩, বিধাননগর, কলকাতা-৭০০ ১০৬, পশ্চিমবঙ্গ
“ILGUS BHAVAN”, H-C Block, Sector - III, Bidhannagar, Kolkata - 700 106, West Bengal

ক্রমিক নং SUDA-229/2018/7809

তারিখ 05/12/19

From: Director, SUDA.

To: The Executive Officer,
Garulia Municipality,
North 24-Parganas.Sub: Requirement of fund for screening across channel/drain discharging to river Ganga
within Garulia Municipality.

Ref: Your Memo no: 449 dated: 31.10.19

Sir,

In reference to the above this is to remind you that in the meeting, on Municipal Solid Waste Management and Monitoring of Ganga Towns, held on 10th July at SUDA Conference Hall, a decision has been taken that work related to screening on small nullah/drain up to the size of 1.2m x 1.2m to be executed by the Municipal Authority of its own. Reimbursement of funds for installation of screens above 1.2m x 1.2m may be claimed with work done estimate duly vetted by the concerned Executive Engineer of KMDA/M.E.Dte. The copy of the said minutes is being attached herewith for your ready reference please.

The rate analysis submitted by your good office are for the screens having size 1.2m x 1.2m, for each and every location. You are hereby again requested to execute the work immediately if not done till date as it relates to direction of Hon'ble National Green Tribunal.

Thanking you,

Yours faithfully,

Encl: As stated above

Director,SUDA

o/c

Draft

From: Director, SUDA.

To: The Executive Officer,
Garulia Municipality,
North 24-Parganas.

Sub: Requirement of fund for screening across channel/drain discharging to river Ganga
within Garulia Municipality.

Ref: Your Memo no: 449 dated: 31.10.19

Sir,

In reference to the above this is to remind you that in the meeting, on Municipal Solid Waste Management and Monitoring of Ganga Towns, held on 10th July at SUDA Conference Hall, a decision has been taken that work related to screening on small nullah/drain up to the size of 1.2m x 1.2m to be executed by the Municipal Authority of its own. Reimbursement of funds for installation of screens above 1.2m x 1.2m may be claimed with work done estimate duly vetted by the concerned Executive Engineer of KMDA/M.E.Dte. The copy of the said minutes is being attached herewith for your ready reference please.

The rate analysis submitted by your good office are for the screens having size 1.2m x 1.2m, for each and every location, ~~and thus~~ you are hereby ~~once~~ again requested to execute the work immediately if not done till date. *as it relates to direction of Hon'ble National Green Tribunal.*

Thanking you,

Yours faithfully,

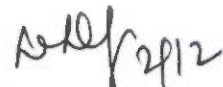

Director, SUDA

Encl: As stated above

Telephone No. 2561-5061

chairman_garulia@rediffmail.com

Fax no. 2540-8432 (033)

URGENT

Office of the Councillors, Garulia Municipality

P.O. Garulia, Dist – North 24 Parganas

SRI SUNIL NASKAR

Executive Officer

Garulia Municipality

EE(SD)
Pmt up pt.
Bof

Memo No: 449

Date: 31-10-2019

To
The Director
State Urban Development Agency
ILGUS BHAVAN, H.C. Block, Sector-III
Bidhannagar, Kolkata-700106



CM

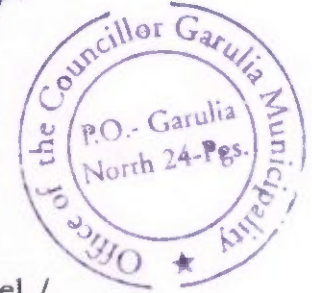

Ref: Our Office Letter No.417 dated 22-10-2019

Sub: Requirement of Fund for Screening across Channel / Drain of Garulia Municipality

Sir/Madam,

Further to our above mentioned Letter, I am submitting the duly vetted Estimate by KMDA for Screening across Channel / Drain of Garulia Municipality for early sanction of such Fund.

This is for your kind information and taking necessary action.

Thanking you,

Yours faithfully,

Executive Officer
Garulia Municipality

Enclo: Vetted Estimate by KMDA

URGENT
Sri S. Chatterjee, AE / Sri S. Misra, AB
for n.a.pt.
for
21/11/19



OFFICE OF THE CHIEF ENGINEER
PM & C SECTOR (DESIGN & VETTING UNIT)

**Kolkata
Metropolitan
Development
Authority**

No. 144/KMDA/PM & C (D&V)/W-2/17

Date: 01/10/2019

To
The Chairman
Garulia Municipality

**Sub: Vetting of estimates for Screening across Channels / Drains
for Garulia Municipality**

Sir,

Ten nos. of estimates for the above-mentioned work were submitted for vetting vide your memo no. 318, dated 07/09/2019 to the Chief Executive Officer, KMDA. The estimated value of the estimates were **Rs. 2,25,820.00**. The estimates were forwarded to this sector on 14/09/2019 for vetting.

After thorough checking and several rounds of interaction with your Engineer, the estimates are hereby vetted for an amount **Rs. 2,54,340.00** including GST and Labour Welfare Cess but without any provision for contingency.

I would request you to receive the vetted scheme from the office of the undersigned for further necessary action.

Thanking you,

Yours faithfully

Chief Engineer
PM & C Sector
(Design & Vetting Unit)

Encl. Two copies of the vetted estimate and Drawing

No. 144/1(2)/KMDA/PM & C (D&V)/W-2/17

Date: 01/10/2019

Copy forwarded for kind information to:

1. The Chief Executive Officer, KMDA
2. Sri Pradip Naskar, Executive Engineer, PM & C (D&V Unit) Sector

Chief Engineer
PM & C Sector
(Design & Vetting Unit)

Rate Analysis of Grating 1.2 m x 1.2m

Sl.No.	Particulars of item	Amount (Rs.)
1	M.S structural work in columns, beams etc. with simple rolled structural members (e.g.) joints, angle, channel sections conforming to IS 226, IS:808 & SP (6)-1964 connected to one another with bracket, gussets cleats as per design, direction of Engineer-incharge complete including cutting to requisite shape and length, fabrication with necessary bolting meter arewelding conforming to IS 816-1969 & IS 1995 using electrodes of approved make and brand conforming to IS 814-2004 haulage hoisting and erection all complete. The rate includes the cost of rolled steel section, consumables such as electrodes gas and hire charges such as electricity charges, labour insurance charges etc. (PWD 2017 (Building). IT. No. 2A, Page No. 101) <i>3rd corrigendum</i> 2Nos. Channels in sides of grating=2 x 3.5m @16.8Kg/meter=117.6Kg @Rs.60276 per M.T.=0.1176x60276=Rs.7088.46 <i>73.92</i> 73761 73761 5452.41	5452.41 X 10 7088.46 X 10 7088.46 = 54524.10
2	M.S work in framed gratings of gratings of window etc made of round or square bars and frame work or M.S. flats (with the bars securely fixed to the flat bar frame) with or without intermediate flat bar stiffener and fixed with necessary screws etc. complete as directed (P.W.D.2017 (Building). IT No.12, Page No.104) <i>3rd corrigendum</i> 35Kg/sqm=50.4Kg. 0.504 Qnti Total-1.2m x 1.2m @ @Rs.6299.00 per qnti. for <i>8823</i> = 4446.79	4446.79 X 10 3174.69 X 10 21718.90 = 44467.90
3	Reinforced cement concrete-M-20, 1Cum. @Rs.5837.86 <i>P-24, it-500 3rd corrigendum 6250.00</i>	6250.00 X 10 5837.86 X 10 59278.60 62500.
4	Steel reinforcement for R.C.C. Work @1% of RCC value-78.5Kg @ Rs.67081/Mt. <i>2nd corrigendum</i> <i>71416.00</i>	5606.76 X 10 5265.86 X 10 52658.60 56067.60
5	Providing anti-crossive protective coating to inhibit the corrossion to HYSD reinforcements including two coats of anti-corrosive coatings of consumption as per manufacturer's spesification, complete as per the direction of the Engineer-in-Charge. (P.W.D 2018 (Roads) IT No-16.21, Pg.322) Rs.506.00per Sqm. Total 1.2x1.2=1.44Sq. @	728.64 X 10 = 7286.40 728.64 X 10 7286.40
224840.90		Total Rs. 22095.51 X 10 = 220955.10
26980.91		Adding 12% GST Rs. 265.46 X 265.46 = 70.46
2518.22		Adding 1% Cess over GST added amount Rs. 220.95 X 220.95 = 49.00
254340.03		Total Rs. 22581.92 X 22581.92 = 508195.00
Say 254340.00		Say Rs. 22582.00 X 10 = 225820.00

In words Rupees Twenty Two thousand Five hundred Eighty two only = 2,25,820/-

~~Rs Two lakh twenty five thousand~~
~~& Eight hundred twenty four only~~
Rupees two lakh fifty four thousand three hundred forty only.

Checked and Verified by Estimator

Amount of INR...
(Excluding the Contingency Charges
Electrical Work and DPI
Preparation charges)

Sig. of Sub Assistant Engineer
Garulia Municipality
Sub-Assistant Engineer,
Garulia Municipality

Sig of Chirman
Garulia Municipality
Chairman
Garulia Municipality

Junior Engineer (C)
M&C Sector (Design & Vetting Unit)
K. M. D. A.

Assistant Engineer (C)
PM&C Sector (Design & Vetting Unit)
K. M. D. A.

Amount Rs=25434 x 10 Nos.

₹ 2,54,340.00

VETTED

~~Drankar~~
30/9/19

Executive Engineer (C)
PM&C Sector (Design & Vetting Unit)
K. M. D. A.

~~Gopinath Chellam~~
~~9433430687~~

~~R. Chellam~~ 11/10/19

Addl. Chief Engineer
PM & C Sector
(Design & Vetting Unit)
K M D A

Amount of IFR
including the Contract
charges

GARULIA MUNICIPALITY

Estimate for Screening across drain at Ratneswar ghat, dunber mill in Ward no 07 Under Garulia Municipality.

Rate Analysis of Grating 1.2 m x 1.2m

Sl.No.	Particulars of item	Amount (Rs.)
1	M.S structural work in columns, beams etc. with simple rolled structural members (e.g.) joints, angle, channel sections conforming to IS 226, IS:808 & SP (6)-1964 connected to one another with bracket, gussets cleats as per design, direction of Engineer-in-charge complete including cutting to requisite shape and length, fabrication with necessary bolting meter arewelding conforming to IS 816-1969 & IS 1995 using electrodes of approved make and brand conforming to IS 814-2004 haulage hoisting and erection all complete. The rate includes the cost of rolled steel section, consumables such as electrodes gas and hire charges such as electricity charges, labour insurance charges etc. (PWD 2017 (Building). IT. No. 2A , Page No. 101) <i>3rd corrigendum</i> 2Nos. Channels in sides of grating = $2 \times 3.5m @ 16.8Kg/meter = 117.6Kg$ @Rs. 60276 per M.T. = $0.1176 \times 60276 = Rs. 7088.46$ <i>73761 0.07392 73761 5452.41 73.72</i>	7088.46 For 5452.41
2	M.S work in framed gratings of gratings of window etc made of round or square bars and frame work or M.S. flats (with the bars securely fixed to the flat bar frame) with or without intermediate flat bar stiffener and fixed with necessary screws etc. complete as directed (P.W.D.2017 (Building). IT No.12, Page No.104) <i>3rd Corrigendum</i> Total-1.2m x 1.2m @ 35Kg/sqm=50.4Kg. 0.504 Qnti @Rs.6299.00 per qnti. for <i>8823.00</i>	3174.69 4446.79
3	Reinforced cement concrete-M-20, 1Cum. @Rs.5837.86 <i>(knal gis) 6250.00</i>	5837.86 6250.00
4	Steel reinforcement for R.C.C. Work @1% of RCC value-78.5Kg @ Rs.67081/Mt. <i>71416.00</i>	5265.86 5606.16
5	Providing anti-crossive protective coating to inhibit the corrossion to HYSD reinforcements including two coats of anti-corrosive coatings of consumption as per manufacturer's spesification, complete as per the direction of the Engineer-in-Charge. (P.W.D 2018 (Roads) IT No-16.21, Pg.322) Rs.506.00per Sqm.	728.64
Total Rs.		22095.51 <i>22484.09</i>
Adding 12% GST Rs.		265.46 <i>2608.09</i>
Adding 1% Cess over GST added amount Rs.		220.95 <i>251.82</i>
Contingency 3% = 755.46		Total Rs. 22581.92 <i>25434.00</i>
Total project cost = 26189.46		Say Rs. 22582.00

In words Rupees Twenty Two thousand Five hundred Eighty two only

Twenty five thousand four hundred thirty four only.

26/09/19
Junior Engineer (C)
&C Sector (Design & Vetting Unit)
K. M. D. A.

F Juan
Sig. of Sub Assistant Engineer
Garulia Municipality
M&C Sector (Design & Vetting Unit)
Sub-Assistant Engineer
Garulia Municipality
27/9/19
K. M. D. A.

Chairman
Sig of Chirman
Garulia Municipality
Chairman
Garulia Municipality

Rs. 25,434.00

VETTED

Handwritten: 30/9/19

Executive Engineer (C)
PM&C Sector (Design & Vetting Unit)
K. M. D. A.

Handwritten: 1/10/19

Addl. Chief Engineer
PM & C Sector
(Design & Vetting Unit)
K M D A

Handwritten notes:
22-10-19
21-10-19
20-10-19

6/5 of Chairman
Panel Members
The District
General Manager

Handwritten signatures:
[Signature]
[Signature]

Handwritten: 1/10/19

GARULIA MUNICIPALITY

Estimate for Screening across drain at Kangalighat, Old Ferry ghat in Ward no 08 Under Garulia Municipality.

Rate Analysis of Grating 1.2 m x 1.2m

Sl.No.	Particulars of item	Amount (Rs.)
1	M.S structural work in columns, beams etc. with simple rolled structural members (e.g.) joints, angle, channel sections conforming to IS 226, IS:808 & SP (6)-1964 connected to one another with bracket, gussets cleats as per design, direction of Engineer-in-charge complete including cutting to requisite shape and length, fabrication with necessary bolting meter arewelding conforming to IS 816-1969 & IS 1995 using electrodes of approved make and brand conforming to IS 814-2004 haulage hoisting and erection all complete. The rate includes the cost of rolled steel section, consumables such as electrodes gas and hire charges such as electricity charges, labour insurance charges etc. (PWD 2017 (Building). IT. No. 22, Page No 101) <i>3rd corrigendum</i> For 2Nos. Channels in sides of grating=2 x 3.5m @16.8Kg/meter=117.6Kg @Rs.60276 per M.T.=0.1176x60276=Rs.7088.46 <i>73761 0.0739 73761 5452.41 73.22</i>	7088.46 <i>5452.41</i>
2	M.S work in framed gratings of gratings of window etc made of round or square bars and frame work or M.S. flats (with the bars securely fixed to the flat bar frame) with or without intermediate flat bar stiffener and fixed with necessary screws etc. complete as directed (P.W.D.2017 (Building). IT No.12, Page No.104) <i>3rd Corrigendum</i> 35Kg/sqm=50.4Kg. 0.504 Qnti Total-1.2m x 1.2m @ @Rs.6299.00 per qnti. for <i>8823.00</i>	3174.69 <i>4446.79</i>
3	Reinforced cement concrete-M-20, 1Cum. @Rs.5837.86 <i>(Analysis) 6250.09</i>	5837.86 <i>6250.09</i>
4	Steel reinforcement for R.C.C. Work @1% of RCC value-78.5Kg @ Rs.67081/Mt. <i>7146.00</i>	5265.86 <i>5606.16</i>
5	Providing anti-crossive protective coating to inhibit the corrossion to HYSD reinforcements including two coats of anti-corrosive coatings of consumption as per manufacturer's spesification, complete as per the direction of the Engineer-in-Charge. (P.W.D 2018 (Roads) IT No-16.21, Pg.322) Rs.506.00per Sqm.	728.64
Total Rs.		22095.51 <i>22484.09</i>
Adding 12% GST Rs.		265.46 <i>2608.09</i>
Adding 1% Cess over GST added amount Rs.		220.95 <i>251.82</i>
Contingency 3% = 755.46.		Total Rs. 22581.92 <i>25434.00</i>
Total project cost = 26189.46.		Say Rs. 22582.00
In words Rupees Twenty Two thousand Five hundred Eighty two only		

(Rupees Twenty five thousand four hundred thirty four only)

26/09/19
Junior Engineer (C)
&C Sector (Design & Vetting Unit)
K. M. D. A.

[Signature]
Sig of Sub Assistant Engineer
Garulia Municipality
Sub-Assistant Engineer
Garulia Municipality

28/9/19
Assistant Engineer (C)
PM&C Sector (Design & Vetting Unit)
K. M. D. A.

[Signature]
Sig of Chirman
Garulia Municipality
Chairman
Garulia Municipality

Rs. 25434.00

VETTED

Pranav
30/9/19
Executive Engineer (C)
PM&C Sector (Design & Vetting Unit)
K. M. D. A.

[Signature]
11/10/19
Addl. Chief Engineer
PM & C Sector
(Design & Vetting Unit)
K M D A

GARULIA MUNICIPALITY

Estimate for Screening across drain at Kangalighat, Thakur bari road in Ward no 08 Under Garulia Municipality.

Rate Analysis of Grating 1.2 m x 1.2m

Sl.No.	Particulars of item	Amount (Rs.)
1	M.S structural work in columns, beams etc. with simple rolled structural members (e.g.) joints, angle, channel sections conforming to IS 226, IS:808 & SP (6)-1964 connected to one another with bracket, gussets cleats as per design, direction of Engineer-in-charge complete including cutting to requisite shape and length, fabrication with necessary bolting meter arewelding conforming to IS 816-1969 & IS 1995 using electrodes of approved make and brand conforming to IS 814-2004 haulage hoisting and erection all complete. The rate includes the cost of rolled steel section, consumables such as electrodes gas and hire charges such as electricity charges, labour insurance charges etc. (PWD 2017 (Building). IT. No.-2A, Page No.104) <i>3rd corrigendum</i> For 2Nos. Channels in sides of grating=2 x 3.5m @16.8Kg/meter=117.6Kg @Rs.60276 per M.T.=0.1176x60276=Rs.7088.46 <i>73761 0.67392 73761 5452.41 73.92</i>	7088.46 <i>5452.41</i>
2	M.S work in framed gratings of gratings of window etc made of round or square bars and frame work or M.S. flats (with the bars securely fixed to the flat bar frame) with or without intermediate flat bar stiffener and fixed with necessary screws etc. complete as directed (P.W.D.2017 (Building). IT No.12, Page No.104) <i>3rd Corrigendum</i> Total-1.2m x 1.2m @ 35Kg/sqm=50.4Kg. 0.504 Qnti @Rs.6299.00 per qnti. for <i>8823</i>	3174.69 <i>4446.79</i>
3	Reinforced cement concrete-M-20, 1Cum.@Rs.5837.86 <i>(Analysis) 6250.09</i>	5837.86 <i>6250.09</i>
4	Steel reinforcement for R.C.C. Work @1% of RCC value-78.5Kg @ Rs.67081/Mt. <i>71416.00</i>	5265.86 <i>5606.16</i>
5	Providing anti-crossive protective coating to inhibit the corrossion to HYSD reinforcements including two coats of anti-corrosive coatings of consumption as per manufacturer's spesification, complete as per the direction of the Engineer-in-Charge. (P.W.D 2018 (Roads) IT No-16.21, Pg.322) Rs.506.00per Sqm.	728.64
Total Rs.		22095.51 <i>22484.09</i>
Adding 12% GST Rs.		265.46 <i>2698.00</i>
Adding 1% Cess over GST added amount Rs.		220.95 <i>251.82</i>
<i>Contingency 3% = 755.46</i>		Total Rs. 22581.92 <i>25184.00</i>
<i>Total project cost = 26189.46.</i>		Say Rs. 22582.00

In words Rupees Twenty Two thousand Five hundred Eighty two only

(Rupees Twenty five thousand four hundred thirty four only)

24/09/19
Junior Engineer (C)
M&C Sector (Design & Vetting)
K. M. D. A.
Sig. of Sub Assistant Engineer
Garulia Municipality
Sub-Assistant Engineer
Garulia Municipality

27/9/19
Assistant Engineer (C)
M&C Sector (Design & Vetting)
K. M. D. A.

20/09/19
Sig of Chirman
Garulia Municipality
Chairman
Garulia Municipality

Rs. 25434.00

VETTED

~~Dr. Aravind~~
30/9/19
Executive Engineer (C)
PM&C Sector (Design & Vetting Unit)
K. M. D. A.

20/10/19
Addl. Chief Engineer
PM & C Sector
(Design & Vetting Unit)
K M D A

GARULIA MUNICIPALITY

Estimate for Screening across drain at babughat ,Ferryghat in Ward no 19 Under Garulia Municipality.

Rate Analysis of Grating 1.2 m x 1.2m

Sl.No.	Particulars of item	Amount (Rs.)
1	M.S structural work in columns, beams etc. with simple rolled structural members (e.g.) joints, angle, channel sections conforming to IS 226, IS:808 & SP (6)-1964 connected to one another with bracket, gussets cleats as per design, direction of Engineer-incharge complete including cutting to requisite shape and length, fabrication with necessary bolting meter arewelding conforming to IS 816-1969 & IS 1995 using electrodes of approved make and brand conforming to IS 814-2004 haulage hoisting and erection all complete. The rate includes the cost of rolled steel section, consumables such as electrodes gas and hire charges such as electricity charges, labour insurance charges etc. (PWD 2017 (Building). IT. No. 24, Page No. 101) <i>3rd Corrigendum</i> For 2Nos. Channels in sides of grating=2 x 3.5m @16.8Kg/meter= 117.6Kg @Rs.60276 per M.T.= 0.1176x60276=Rs.7088.46 <i>73.92</i> <i>73761 0.07392 73761 5452.41</i>	7088.46 5452.41
2	M.S work in framed gratings of gratings of window etc made of round or square bars and frame work or M.S. flats (with the bars securely fixed to the flat bar frame) with or without intermediate flat bar stiffener and fixed with necessary screws etc. complete as directed (P.W.D.2017 (Building). IT No.12, Page No.104) <i>3rd Corrigendum</i> Total-1.2m x 1.2m @ 35Kg/sqm=50.4Kg. 0.504 Qnti @Rs.6299.00 per qnti. for <i>5823.00</i>	4446.79 3274.69
3	Reinforced cement concrete-M-20, 1Cum. @Rs.5837.86 <i>(Analysis) 6250.09</i>	5837.86 6250.09
4	Steel reinforcement for R.C.C. Work @1% of RCC value-78.5Kg @ Rs.67081/Mt. <i>71416.00</i>	5265.86 5606.16
5	Providing anti-crossive protective coating to inhibit the corrossion to HYSD reinforcements including two coats of anti-corrosive coatings of consumption as per manufacturer's spesification, complete as per the direction of the Engineer-in-Charge. (P.W.D 2018 (Roads) IT No-16.21, Pg.322) Rs.506.00 per Sqm.	728.64
Total Rs.		22095.51 <i>22484.05</i>
Adding 12% GST Rs.		265.46 <i>2698.05</i>
Adding 1% Cess over GST added amount Rs.		220.95 <i>251.82</i>
Contingency 3% = 755.46		Total Rs. 22581.92 <i>25434.0</i>
Total project cost = 26183.16		Say Rs. 22582.00

In words Rupees Twenty Two thousand Five hundred Eighty two only

Twenty five thousand four hundred thirty four only.

26/09/19
Junior Engineer (C)
M&C Sector (Design & Vetting Unit)
K. M. D. A.

[Signature]
Sig. of Sub Assistant Engineer
Garulia Municipality
Sub-Assistant Engineer
Garulia Municipality

27/9/19
Assistant Engineer (C)
M&C Sector (Design & Vetting Unit)
K. M. D. A.

[Signature]
Sig of Chirman
Garulia Municipality
Chairman
Garulia Municipality

Rs. 25434.00

VETTED

Drankor
30/9/19

Executive Engineer (C)
PM&C Sector (Design & Vetting Unit)
K. M. D. A.

R. D. Jeyaraj
11/10/19

Addl. Chief Engineer
PM & C Sector
(Design & Vetting Unit)
K M D A

GARULIA MUNICIPALITY

Estimate for Screening across drain at babughat (colony), Dr. M.M. banerjee bye lane in Ward no 19 Under Garulia Municipality.

Rate Analysis of Grating 1.2 m x 1.2m

Sl.No.	Particulars of item	Amount (Rs.)
1	M.S structural work in columns, beams etc. with simple rolled structural members (e.g.) joints, angle, channel sections conforming to IS 226, IS:808 & SP (6)-1964 connected to one another with bracket, gussets cleats as per design, direction of Engineer-in-charge complete including cutting to requisite shape and length, fabrication with necessary bolting meter arewelding conforming to IS 816-1969 & IS 1995 using electrodes of approved make and brand conforming to IS 814-2004 haulage hoisting and erection all complete. The rate includes the cost of rolled steel section, consumables such as electrodes gas and hire charges such as electricity charges, labour insurance charges etc. (PWD 2017 (Building). IT. No. 2A, Page No. 104) For 2Nos. Channels in sides of grating=2 x 3.5m @16.8Kg/meter= 117.6Kg 73.92 @Rs.60276 per M.T.=0.1176x60276=Rs.7088.46 73761 0.07392 73761 5452.41	7088.46 5452.41
2	M.S work in framed gratings of gratings of window etc made of round or square bars and frame work or M.S. flats (with the bars securely fixed to the flat bar frame) with or without intermediate flat bar stiffener and fixed with necessary screws etc. complete as directed (P.W.D.2017 (Building). IT No.12, Page No.104) Total-1.2m x 1.2m @ 35Kg/sqm=50.4Kg. 3rd corrigendum @Rs.6299.00 per qnti. for 0.504 Qnti 8823.00	3174.89 4446.79
3	Reinforced cement concrete-M-20, 1Cum. @Rs.5837.86 Analysis 6250.09	5837.86 6250.09
4	Steel reinforcement for R.C.C. Work @1% of RCC value-78.5Kg @ Rs.67081/Mt. 71416.00	5265.86 5606.16
5	Providing anti-crossive protective coating to inhibit the corrossion to HYSD reinforcements including two coats of anti-corrosive coatings of consumption as per manufacturer's spesification, complete as per the direction of the Engineer-in-Charge. (P.W.D 2018 (Roads) IT No-16.21, Pg.322) Total 1.2x1.2=1.44Sq. @ Rs.506.00per Sqm.	728.64
Total Rs.		22095.51 22484.00
Adding 12% GST Rs.		265.46 2698.09
Adding 1% Cess over GST added amount Rs.		220.95 251.82
Contingency 3% = 755.46 Total Project Cost = 26189.46		Total Rs. 22581.92 25434.00
Say Rs.		22582.00

In words Rupees Twenty Two thousand Five hundred Eighty two only

Twenty five thousand four hundred thirty four only

26/09/19
Junior Engineer (C)
PM&C Sector (Design & Vetting Unit)
K. M. D. A.

[Signature]
Sig. of Sub Assistant Engineer
Garulia Municipality
Sub-Assistant Engineer
Garulia Municipality

[Signature]
23/9/19
Assistant Engineer (C)
PM&C Sector (Design & Vetting Unit)
K. M. D. A.

[Signature]
Sig of Chirman
Garulia Municipality
Chairman
Garulia Municipality

Rs. 25434.00

VETTED

Handwritten:
30/9/19

Executive Engineer (C)
PM&C Sector (Design & Vetting Unit)
K. M. D. A.

Handwritten:
11/9/19

Addl. Chief Engineer
PM & C Sector
(Design & Vetting Unit)
K M D A

GARULIA MUNICIPALITY

Estimate for Screening across drain at Bichalighat, Girishghat in Ward no 19 Under Garulia Municipality.

Rate Analysis of Grating 1.2 m x 1.2m

Sl.No.	Particulars of item	Amount (Rs.)
1	M.S structural work in columns, beams etc. with simple rolled structural members (e.g.) joints, angle, channel sections conforming to IS 226, IS:808 & SP (6)-1964 connected to one another with bracket, gussets cleats as per design, direction of Engineer-in-charge complete including cutting to requisite shape and length, fabrication with necessary bolting meter arewelding conforming to IS 816-1969 & IS 1995 using electrodes of approved make and brand conforming to IS 814-2004 haulage hoisting and erection all complete. The rate includes the cost of rolled steel section, consumables such as electrodes gas and hire charges such as electricity charges, labour insurance charges etc. (PWD 2017 (Building). IT. No. 2A, Page No. 101) For 2Nos. Channels in sides of grating=2 x 3.5m @16.8Kg/meter=117.6Kg @Rs.60276 per M.T.=0.1176x60276=Rs.7088.46 <i>73761 0.07392 73761 5452.41 73.92</i>	7088.46 5452.41
2	M.S work in framed gratings of gratings of window etc made of round or square bars and frame work or M.S. flats (with the bars securely fixed to the flat bar frame) with or without intermediate flat bar stiffener and fixed with necessary screws etc. complete as directed (P.W.D.2017 (Building). IT No.12, Page No.104) Total-1.2m x 1.2m @ 35Kg/sqm=50.4Kg. @Rs.6299.00 per qnti. for 0.504 Qnti <i>3rd Corrigendum 8823</i>	3174.69 4446.79
3	Reinforced cement concrete-M-20, 1Cum. @Rs.5837.86 <i>(Analysis) 6250.09</i>	5837.86 6250.09
4	Steel reinforcement for R.C.C. Work @1% of RCC value-78.5Kg @ Rs.67081/Mt. <i>71416.00</i>	5265.86 5606.16
5	Providing anti-crossive protective coating to inhibit the corrossion to HYSD reinforcements including two coats of anti-corrosive coatings of consumption as per manufacturer's spesification, complete as per the direction of the Engineer-in-Charge. (P.W.D 2018 (Roads) IT No-16.21, Pg.322) Total 1.2x1.2=1.44Sq. @ Rs.506.00 per Sqm.	728.64
Total Rs.		22095.51 <i>22484.00</i>
Adding 12% GST Rs.		265.46 <i>2698.09</i>
Adding 1% Cess over GST added amount Rs.		220.95 <i>251.82</i>
Total Rs.		22581.92 <i>25434.00</i>
Say Rs.		22582.00
Contingency 3% = 755.46		
Total Project Cost = 26189.46		

In words Rupees Twenty Two thousand Five hundred Eighty two only

Twenty five thousand four hundred thirty four only.

26/09/19
Junior Engineer (C)
IC Sector (Design & Vetting Unit)
K. M. D. A.

[Signature]
Sig. of Sub Assistant Engineer
Garulia Municipality
Sub-Assistant Engineer
Garulia Municipality

[Signature]
27/9/19
Assistant Engineer (C)
PM&C Sector (Design & Vetting Unit)
K. M. D. A.

[Signature]
Sig of Chirman
Garulia Municipality
Chairman
Garulia Municipality

Rs. 25434.00

VETTED

Handwritten signature
30/9/19

Executive Engineer (C)
PM&C Sector (Design & Vetting Unit)
K. M. D. A.

Handwritten signature
11/10/19

Addl. Chief Engineer
PM & C Sector
(Design & Vetting Unit)
K M D A

Handwritten notes and scribbles

Handwritten notes and scribbles

Handwritten notes and scribbles

Handwritten notes and scribbles

Handwritten notes and scribbles

Handwritten notes and scribbles

Handwritten notes and scribbles

GARULIA MUNICIPALITY

Estimate for Screening across drain at Bichalighat, near kalyan pally in Ward no 19 Under Garulia Municipality.

Rate Analysis of Grating 1.2 m x 1.2m

Sl.No.	Particulars of item	Amount (Rs.)
1	M.S structural work in columns, beams etc. with simple rolled structural members (e.g.) joints, angle, channel sections conforming to IS 226, IS:808 & SP (6)-1964 connected to one another with bracket, gussets cleats as per design, direction of Engineer-in-charge complete including cutting to requisite shape and length, fabrication with necessary bolting meter arewelding conforming to IS 816-1969 & IS 1995 using electrodes of approved make and brand conforming to IS 814-2004 haulage hoisting and erection all complete. The rate includes the cost of rolled steel section, consumables such as electrodes gas and hire charges such as electricity charges, labour insurance charges etc. (PWD 2017 (Building). IT. No. 2A, Page No. 101) For 2Nos. Channels in sides of grating=2 x 3.5m @16.8Kg/meter=117.6Kg @Rs.60276 per M.T.=0.1176x60276=Rs.7088.46 <i>73761 0.073273761 5452.41 73.92</i>	5452.41 7088.46
2	M.S work in framed gratings of gratings of window etc made of round or square bars and frame work or M.S. flats (with the bars securely fixed to the flat bar frame) with or without intermediate flat bar stiffener and fixed with necessary screws etc. complete as directed (P.W.D.2017 (Building). IT No.12, Page No.104) Total-1.2m x 1.2m @ 35Kg/sqm=50.4Kg. @Rs.6299.00 per qnti. for 0.504 Qnti <i>3rd corrigendum 8823.00</i>	3174.69 4446.79
3	Reinforced cement concrete-M-20, 1Cum. @Rs.5837.86 <i>(Analysis) 6250.09</i>	5837.86 6250.09
4	Steel reinforcement for R.C.C. Work @1% of RCC value-78.5Kg @ Rs.67081/Mt. <i>1416.00</i>	5265.86 5606.16
5	Providing anti-crossive protective coating to inhibit the corrosion to HYSD reinforcements including two coats of anti-corrosive coatings of consumption as per manufacturer's specification, complete as per the direction of the Engineer-in-Charge. (P.W.D 2018 (Roads) IT No-16.21, Pg.322) Total 1.2x1.2=1.44Sq. @ Rs.506.00 per Sqm.	728.64
Total Rs.		22095.51 22484.09
Adding 12% GST Rs.		265.46 2698.09
Adding 1% Cess over GST added amount Rs.		220.95 251.82
Contingency 3% = 755.46		Total Rs. 22581.92 25434.0
Total Project Cost = 26189.46		Say Rs. 22582.00

In words Rupees Twenty Two thousand Five hundred Eighty two only

Twenty five thousand four hundred thirty four only.

26/09/19
Junior Engineer (C)
PM&C Sector (Design & Vetting Unit)
K. M. D. A.

[Signature]
Sig. of Sub Assistant Engineer
Garulia Municipality
Sub-Assistant Engineer
Garulia Municipality

23/9/19
Assistant Engineer (C)
PM&C Sector (Design & Vetting Unit)
K. M. D. A.

[Signature]
Sig of Chirman
Garulia Municipality

Rs. 25434.00

VETTED

Handwritten signature
30/9/19

Executive Engineer (C)
PM&C Sector (Design & Vetting Unit)
K. M. D. A.

Handwritten signature
11/10/19

Addl. Chief Engineer
PM & C Sector
(Design & Vetting Unit)
K M D A

NAIHATI MUNICIPALITY

- 1) Total No. Screens have been made= 14 Nos.
- 2) Total No. Screens have been installed= 4 Nos.
- 3) Total No. of Screens to be installed= 10 Nos.

27/08/19
Executive Officer
NAIHATI MUNICIPALITY



Director SUDA <sbm.wbsuda@gmail.com>

Titagarh Municipality

1 message

Titagarh Municipality <titagarh2007@yahoo.com>
Reply-To: "titagarh2007@yahoo.com" <titagarh2007@yahoo.com>
To: Director SUDA <sbm.wbsuda@gmail.com>

Tue, Aug 27, 2019 at 5:49 PM

This is for your kind information that installation of screens have been completed at 03 points.

রাজ্য নগর উন্নয়ন সংস্থা

STATE URBAN DEVELOPMENT AGENCY

“ইলগাস ভবন”, এইচ-সি ব্লক, সেক্টর-৩, বিধাননগর, কলকাতা-৭০০ ১০৬, পশ্চিমবঙ্গ
 “ILGUS BHAVAN”, H-C Block, Sector - III, Bidhannagar, Kolkata - 700 106, West Bengal

ক্রমিক নং SUDA-229/2018/7001

তারিখ 18.10.2019

From : The Director, SUDA,
 To : The Administrator /Chairman/Chairperson
 Mahestala Municipality
 Subject : Compliance of the direction of the West Bengal State Level Monitoring
 Committee on SWM under Honourable NGT
 Ref letter No : 1. SUDA - 229/2019/5792 - H Dated : 21/08/2019
 2. SUDA - 332/2019/5354 Dated : 09/08/2019
 3. SUDA - 229/2018/4838 Dated : 24/07/2019
 4. SUDA - 50/2016/4505 (42) Dated : 05/07/2019

Sir/Madam,

As per reports provided from your end regarding installation of screens on Nullah/Drains/Outfall discharging into the river GANGA the following observations are recorded.

- No of the Nullah/Drains/Outfall under your municipality :- 10 Nos
- No of the Nullah/Drains/Outfall where Screens to be installed :- 01 Nos

In this connection you are requested to submit an action taken report regarding installation of screens and also to share the actual position of the work done by other departments regarding the same on the drains under their control if any, positively by 23.10.2019 for submission of the same before to the West Bengal State Level Monitoring Committee on SWM under Honourable NGT.

- Please treat this as extremely Urgent.

Yours faithfully



Director, SUDA

Date :

Memo No -

Copy Forwarded for kind information to

1. P.S. to Principal Secretary with a request to put up before his perusal please.

Director, SUDA

দূরভাষ : ২৩৫৮ ৬৪০৩ / ৫৭৬৭, ফ্যাক্স : ২৩৫৮ ৫৮০০

Tel : 2358 6403/5767, Fax : 2358 5800, E-mail : wbsudadir@gmail.com

Account Section : 2358 6408

STATE URBAN DEVELOPMENT AGENCY

“ইলগাস ভবন”, এইচ-সি ব্লক, সেক্টর-৩, বিধাননগর, কলকাতা-৭০০ ১০৬, পশ্চিমবঙ্গ

“ILGUS BHAVAN”, H-C Block, Sector - III, Bidhannagar, Kolkata - 700 106, West Bengal

ক্রমিক নং SUDA-229/2018/7000
From : The Director, SUDA,

তারিখ 18.10.2019

To : The Administrator /Chairman/Chairperson
Champdany MunicipalitySubject : Compliance of the direction of the West Bengal State Level Monitoring
Committee on SWM under Honourable NGTRef letter No : 1. SUDA - 229/2018/5792-B Dated : 21/08/2019
2. SUDA - 332/2019/5354 Dated : 09/08/2019
3. SUDA - 229/2018/4838 Dated : 24/07/2019
4. SUDA - 50/2016/4505 (42) Dated : 05/07/2019

Sir/Madam,

As per reports provided from your end regarding installation of screens on Nullah/Drains/Outfall discharging into the river GANGA the following observations are recorded.

- No of the Nullah/Drains/Outfall under your municipality :- 02 Nos
- No of the Nullah/Drains/Outfall where Screens to be installed :- 01 Nos

In this connection you are requested to submit an action taken report regarding installation of screens and also to share the actual position of the work done by other departments regarding the same on the drains under their control if any, positively by 23.10.2019 for submission of the same before to the West Bengal State Level Monitoring Committee on SWM under Honourable NGT.

- Please treat this as extremely Urgent.

Yours faithfully

Director, SUDA

Date :

Memo No -

Copy Forwarded for kind information to

1. P.S. to Principal Secretary with a request to put up before his perusal please.

Director, SUDA

ক্রমিক নং SUDA-229/2018/7002

তারিখ 18.10.2019

From : The Director, SUDA,

To : The Special Commissioner
Kolkata Municipal CorporationSubject : Compliance of the direction of the West Bengal State Level Monitoring
Committee on SWM under Honourable NGT.

Ref letter No : 1. SUDA - 229/2018/5793 A	Dated : 21/08/2019
2. SUDA - 332/2019/5354	Dated : 09/08/2019
3. SUDA - 229/2018/4845	Dated : 24/07/2019
4. SUDA - 50/2016/4505 (42)	Dated : 05/07/2019

Sir/Madam,

As per reports provided from your end regarding installation of screens on Nullah/Drains/Outfall discharging into the river GANGA and dumpsites by the bank of the river GANGA, the following observations are recorded.

- No of Nullah/Drains/Outfall discharging to River Ganga :- 12Nos
- No of the Nullah/Drains/Outfall where Screens to be installed :- 1 No.

In this connection you are requested to submit an action taken report regarding installation of screens and also to share the actual position of the work done by other departments regarding the same on the drains under their control if any, positively by 23.10.2019 for submission of the same before to the West Bengal State Level Monitoring Committee on SWM under Honourable NGT.

Please treat this as extremely Urgent.

Yours faithfully

 Director, SUDA

Date :

Memo No -

Copy Forwarded for kind information to

1. P.S. to Principal Secretary with a request to put up before his perusal please.

STATE URBAN DEVELOPMENT AGENCY

“ইলগাস ভবন”, এইচ-সি ব্লক, সেক্টর-৩, বিধাননগর, কলকাতা-৭০০ ১০৬, পশ্চিমবঙ্গ
 “ILGUS BHAVAN”, H-C Block, Sector - III, Bidhannagar, Kolkata - 700 106, West Bengal

ক্রমিক নং SUDA-229/2018/6987
 From : The Director, SUDA,

তারিখ 18.10.2019

To : The Administrator /Chairman/Chairperson
 Berhampur Municipality

Subject : Compliance of the direction of the West Bengal State Level Monitoring
 Committee on SWM under Honourable NGT

Ref letter No : 1. SUDA - 229/2018/5792 A Dated : 21/08/2019
 2. SUDA - 332/2019/5354 Dated : 09/08/2019
 3. SUDA - 229/2018/4837 Dated : 24/07/2019
 4. SUDA - 50/2016/4505 (42) Dated : 05/07/2019

Sir/Madam,

As per reports provided from your end regarding installation of screens on
 Nullah/Drains/Outfall discharging into the river GANGA the following observations are
 recorded.

- No of the Nullah/Drains/Outfall under your municipality :- 19 Nos
- No of the Nullah/Drains/Outfall where Screens to be installed :- 19 Nos

In this connection you are requested to submit an action taken report regarding installation of
 screens and also to share the actual position of the work done by other departments
 regarding the same on the drains under their control if any, positively by 22.10.2019 for
 submission of the same before to the West Bengal State Level Monitoring Committee on SWM
 under Honourable NGT.

Please treat this as extremely Urgent.

Yours faithfully

 Director, SUDA

Memo No - SUDA-229/2018

Date : 18.10.2019

Copy Forwarded for kind information to

1. P.S. to Principal Secretary with a request to put up before his perusal please.

Director, SUDA

রাজ্য নগর উন্নয়ন সংস্থা

STATE URBAN DEVELOPMENT AGENCY

“ইলগাস ভবন”, এইচ-সি ব্লক, সেক্টর-৩, বিধাননগর, কলকাতা-৭০০ ১০৬, পশ্চিমবঙ্গ
 “ILGUS BHAVAN”, H-C Block, Sector - III, Bidhannagar, Kolkata - 700 106, West Bengal

ক্রমিক নং SUDA-229/2018/6985

তারিখ 18.10.2019

From : The Director, SUDA,
 To : The Administrator /Chairman/Chairperson
 Garulia Municipality.
 Subject : Compliance of the direction of the West Bengal State Level Monitoring
 Committee on SWM under Honourable NGT
 Ref letter No : 1. SUDA - 229/2018/5792 A Dated : 21/08/2019
 2. SUDA - 332/2019/5354 Dated : 09/08/2019
 3. SUDA - 229/2018/4839 Dated : 24/07/2019
 4. SUDA - 50/2016/4505 (42) Dated : 05/07/2019

Sir/Madam,

As per reports provided from your end regarding installation of screens on Nullah/Drains/Outfall discharging into the river GANGA the following observations are recorded.

- No of the Nullah/Drains/Outfall under your municipality :- 10 Nos
- No of the Nullah/Drains/Outfall where Screens to be installed :- 10 Nos

In this connection you are requested to submit an action taken report regarding installation of screens and also to share the actual position of the work done by other departments regarding the same on the drains under their control if any, positively by 22.10.2019 for submission of the same before to the West Bengal State Level Monitoring Committee on SWM under Honourable NGT.

Please treat this as extremely Urgent.

Yours faithfully

[Signature] 18/10/19
 Director, SUDA

Memo No -

Date :

Copy Forwarded for kind information to

- P.S. to Principal Secretary with a request to put up before his perusal please.

Director, SUDA

রাজ্য নগর উন্নয়ন সংস্থা

STATE URBAN DEVELOPMENT AGENCY

“ইলগাস ভবন”, এইচ-সি ব্লক, সেক্টর-৩, বিধাননগর, কলকাতা-৭০০ ১০৬, পশ্চিমবঙ্গ
 “ILGUS BHAVAN”, H-C Block, Sector - III, Bidhannagar, Kolkata - 700 106, West Bengal

ক্রমিক নং SUDA-229/2018/6986

তারিখ 18.10.2019

From : The Director, SUDA,

To : The Administrator /Chairman/Chairperson
Haldia Municipality.Subject : Compliance of the direction of the West Bengal State Level Monitoring
Committee on SWM under Honourable NGT

Ref letter No :	1. SUDA - 229/2018/5792 A	Dated : 21/08/2019
	2. SUDA - 332/2019/5354	Dated : 09/08/2019
	3. SUDA - 229/2018/4840	Dated : 24/07/2019
	4. SUDA - 50/2016/4505 (42)	Dated : 05/07/2019

Sir/Madam,

As per reports provided from your end regarding installation of screens on Nullah/Drains/Outfall discharging into the river GANGA the following observations are recorded.

- No of the Nullah/Drains/Outfall under your municipality :- 08 Nos
- No of the Nullah/Drains/Outfall where Screens to be installed :- 08 Nos

In this connection you are requested to submit an action taken report regarding installation of screens and also to share the actual position of the work done by other departments regarding the same on the drains under their control if any, positively by 22.10.2019 for submission of the same before to the West Bengal State Level Monitoring Committee on SWM under Honourable NGT.

Please treat this as extremely Urgent.

Yours faithfully

[Signature] 18/10/19
 Director, SUDA

Memo No - SUDA-229/2018

Date: 18.10.19

Copy Forwarded for kind information to

1. P.S. to Principal Secretary with a request to put up before his perusal please.

Director, SUDA

রাজ্য নগর উন্নয়ন সংস্থা

STATE URBAN DEVELOPMENT AGENCY

“ইলগাস ভবন”, এইচ-সি ব্লক, সেক্টর-৩, বিধাননগর, কলকাতা-৭০০ ১০৬, পশ্চিমবঙ্গ

“ILGUS BHAVAN”, H-C Block, Sector - III, Bidhannagar, Kolkata - 700 106, West Bengal

ক্রমিক নং SUDA-229/2018/6984

তারিখ 18.10.2019

From : The Director, SUDA,
 To : The Commissioner
 Howrah Municipal Corporation
 Subject : Compliance of the direction of the West Bengal State Level Monitoring
 Committee on SWM under Honourable NGT
 Ref letter No : 1. SUDA - 229/2018/5793 B Dated : 21/08/2019
 2. SUDA - 332/2019/5354 Dated : 09/08/2019
 2. SUDA - 229/2018/4842 Dated : 24/07/2019
 3. SUDA - 50/2016/4505 (42) Dated : 05/07/2019

Sir/Madam,

As per reports provided from your end regarding installation of screens on Nullah/Drains/Outfall discharging into the river GANGA the following observations are recorded.

- No of the Nullah/Drains/Outfall within the area of Howrah municipality :- 30 Nos
- No of the Nullah/Drains/Outfall where Screens to be installed :- 05, Nos of which 02 belongs to Irrigation Department, 02 belongs to KMDA and 01 in a private land.

In this connection you are requested to submit an action taken report regarding installation of screens and also to share the actual position of the work done by other departments regarding the same on the drains under their control positively by 22.10.2019 for submission of the same before to the West Bengal State Level Monitoring Committee on SWM under Honourable NGT.

Please treat this as extremely urgent.

Yours faithfully

[Signature]
 Director, SUDA
 Date : 18.10.2019

Memo No - SUDA-229/2018

Copy Forwarded for kind information to

1. P.S. to Principal Secretary with a request to put up before his perusal please.

Director, SUDA

Telephone No. 2561-5061

chairman_garulia@rediffmail.com

Fax no. 2540-8432 (033)

Office of the Councillors, Garulia Municipality

P.O. Garulia, Dist – North 24 Parganas

SRI SUNIL NASKAR

**Executive Officer
Garulia Municipality**

*Emp
EE (BKP) to
take up with
SMD.*

Memo No. 186

Date: 16-07-2019

To
The Programme Director
WBSPMG & CEO, KMDA
UNNAYAN BHAWAN
3rd Floor, DJ-11, Sector-II
Salt Lake City
Kolkata – 700091



Sub: Screening across channels/drains and IEC activities

Ref: Your letter vide Memo No.1796-NGRBA/SPMG/Ganga Committee-
374/2017(P-1) dated 05-04-2019

Sir,

In reference to above and our previous Letter No.19 dated 09-04-2019, I am sending herewith the reminder of the Screening Report alongwith the fund requirement for Screening across channels/drains and IEC activities.

An early action for providing fund may please be ensured.

Thanking you,

Yours faithfully,

S/S
Executive Officer
Garulia Municipality
dt- 16-07-2019

Encl: As stated above

Memo No. 186/1

Copy to:

The Director
State Urban Development Agency
ILGUS BHAVAN, H.C. Block, Sector-III
Bidhannagar, Kolkata-700106

- for information and necessary action.

S/S
16/7/19
Executive Officer
Garulia Municipality
Executive Officer
Garulia Municipality



Office of the
Haldia Municipality

Dr. B.R. Ambedkar Bhawan, Administrative Building, City Centre
P.O.-Debhog, Haldia, Purba Medinipur, West Bengal

☎ : 03224-252996/252997

255051/252644

Fax : 03224-252154

E-mail : haldiamunicipality@gmail.com

Memo No. : 4135/H.M/2019

Date: 27.08.19

To,
The Director,
State Urban Development Agency,
Ilgus Bhaban,
H-C Block, Sector-III,
Bidhannagar,
Kolkata-700106.



**Sub.: Compliance of the direction of the West Bengal State Level
Monitoring Committee on SWM under Hon'ble N.G.T.
Ref.: Your good office Memo No-332/2019/5354 dated-09/08/19.**

Respected Madam,

The report as sought for under subject & reference is given hereunder;

Number of Nullah/Drains/Outfall under this Municipality-08nos.

There are eight lock gate in respect of eight numbers of outfalls which are doing the function of screener and regular cleaning is being done in the lockgate areas.

Besides, estimate for installation of permanent screener estimate has been done by this end. Work order will be issued shortly. Rs.36.14lakh will be spent for the said purpose.

Kindly allow three months time for completion of the total work.

This is for your kind information.

Thanking you,

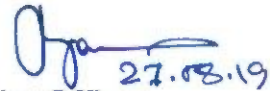

Yours faithfully,

27.08.19

Executive Officer
Haldia Municipality

Sri. S.K. Mishra, AE/SUDA

Please update the report.

02/09/2019

~~Dr. S.~~
EE (BkP)
Pl. i/sent this il
report.
29.8.19



OFFICE OF THE MUNICIPAL COUNCILLORS OF BANSBERIA

Rudra Main Road, P.O. Bansberia, District Hooghly, West Bengal, P.I.N. 712502

Phone No. 033 26346324, Fax No. 26346324, email address: bansb_04@yahoo.com



Memo No:



Date: 17th July 2019

**The General Manager,
Ganges Jute Mill Private Limited
Bansberia, Hooghly, Pin-712502**

AD (sm)
sd
D.M. S. Mishra
P.I.
23-07-19

Sub: Prevention of River Ganga Pollution and Solid Waste Management practices

Sir,

I am to state that this Municipality has received directives from the Deputy Director of State Urban Development Agency, Government of West Bengal and communication made by the Principal Secretary , Urban Development & Municipal Affairs Department, Government of West Bengal that all 40 Ganga Towns should take immediate action on the issue of solid waste management and has to install screens at all outfalls to River Ganga so that solid waste can be arrested from flowing directly into the river Ganga through these Nullahs . In this regard you are requested to put screens on all outfalls /channels leading river Ganga at interval with reasonable distance away from culminating points to arrest or restrict solid waste from flowing directly or indirectly to the river.

You are requested for immediate action to be taken from your good office for the compliance of the order of the Honourable National Green Tribunal to avoid any adverse order in this regard for non compliance.

The Municipal authority is expecting an early action should be taken by 31st July 2019 and requesting to submit an action taken report as early as possible.

Thanking you,

Yours faithfully

sd/—

Chairperson

Dt. 17-7-19 Bansberia Municipality

MEMO- 1567/1

Encl: (1) Copy of the Letter of instruction received from the Principal Secretary , Urban Development & Municipal Affairs Department, Government of West Bengal

Copy forwarded for kind information to : (1) The Director, State Urban Development Agency, Government of West Bengal, ILGUS Bhaban, HC Block, Sector- III, Salt Lake, Kolkata - 700 106

Sri. ~~SD~~ S.K. Mishra

Please

Pal.

02/09/2019



sd/—

Chairperson

Bansberia Municipality

Chairperson

Bansberia Municipality

sd

Telephone No. 2561-5061

chairman_garulia@rediffmail.com

Fax no. 2540-8432 (033)

Office of the Councillors, Garulia Municipality

P.O. Garulia, Dist - North 24 Parganas

SRI SUNIL NASKAR

Executive Officer

Garulia Municipality

EE (BKP)
bap

Memo No: 280

Date: 19-08-19

To
The Programme Director
WBSPMG & CEO, KMDA
UNNAYAN BHAWAN
3rd Floor, DJ-11, Sector-II
Salt Lake City
Kolkata - 700091

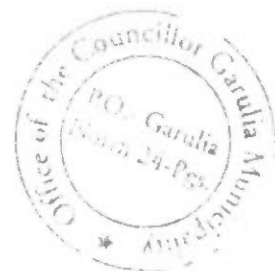

Sub: Screening across channels/drains and IEC activities

Ref: Your letter vide Memo No.1796-NGRBA/SPMG/Ganga Committee-374/2017(P-1) dated 05-04-2019

Sir,

In further reference to above and our previous Letter No.19 dated 09-04-2019 and Letter No.186 dated 16-07-2019, I am sending herewith the reminder of the Screening Report alongwith the fund requirement on urgent basis for Screening across channels/drains and IEC activities.

An early action for providing fund may please be ensured.

Thanking you,

Yours faithfully,

Executive Officer
Garulia Municipality

Enclo: As stated above

Copy to:
The Director
State Urban Development Agency
ILGUS BHAVAN, H.C. Block, Sector-III
Bidhannagar, Kolkata-700106
- for information and necessary action.

Executive Officer
Garulia Municipality

Telephone No.2561-5061 chairman_garulia_rediffmail.com Fax No.2540-8432 (033)
Office of the Councillors, Garulia Municipality
P.O. Garulia, Dist-North 24 Parganas

Sri Sunil Naskar
Executive Officer
Garulia Municipality

Date: 09-04-2019

Memo. 17

To
The Programme Director
WBSPMG & CEO, KMDA
Unnayan Bhawan
3rd Floor, DJ-11, Sector-II,
Salt Lake City, Kolkata-700091.

Sir, Sub: Screening across channels/drains and IEC activities.
Ref: 1796-NGRBA/SPMG/Ganga Committee-374/2017
(P-1) dt.05-04-2019.

In reference to above I am sending herewith the screening report along with the fund requirement for the works to be under taken mention in the said screening report.

This is for your doing needful from your end.

Encl: As stated above

Yours faithfully,

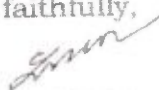
Executive Officer
Garulia Municipality
Executive Officer
Garulia Municipality



Screening report of drains discharging into River Ganga

Name of the drains/Channels	Number of screens installed	location	Ward No.	Type of screening	Requirement of Fund
Ratneswarghat, Garulia	1	Dunbar Mill	7	Type-1	Rs.39,743.00
Kangalighat, Garulia	1	Old Ferryghat	8	Type-1	Rs.39,743.00
Kangalighat, Garulia	1	Thakurbari Road	8	Type-1	Rs.39,743.00
Babughat, Garulia	1	Ferryghat	19	Type-1	Rs.39,743.00
Babughat (Colony), Garulia	1	Dr. M.M. Banerjee Rd. bye lane	19	Type-1	Rs.39,743.00
Bichalighat, Garulia	1	Girishghat	19	Type-1	Rs.39,743.00
Bichalighat, Garulia	1	Near Kalyan Pally, Garulia	19	Type-1	Rs.39,743.00
Bichalighat, Garulia	1	Bichalighat	19	Type-1	Rs.39,743.00
Old Burning ghat, Garulia	1	Old Burning Ghat, Garulia	19	Type-1	Rs.39,743.00
Pacha khal	1	Near Lock Gate	20	Type-1	Rs.39,743.00
				Total	Rs. 3,97,430.00

Kuldeep
29/4/19

Sub-Assistant Engineer
Garulia Municipality
Sub-Assistant Engineer
Garulia Municipality



9/4/19

Executive Officer
Garulia Municipality
Executive Officer
Garulia Municipality

Telephone No. 2561-5061

chairman_garulia@rediffmail.com

Fax no. 2540-8432 (033)

Office of the Councillors, Garulia Municipality

P.O. Garulia, Dist - North 24 Parganas

SRI SUNIL NASKAR

Executive Officer

Garulia Municipality

Memo No. 186

Date: 16-07-2019

To
The Programme Director
WBSPMG & CEO, KMDA
UNNAYAN BHAWAN
3rd Floor, DJ-11, Sector-II
Salt Lake City
Kolkata - 700091



Sub: Screening across channels/drains and IEC activities

Ref: Your letter vide Memo No.1796-NGRBA/SPMG/Ganga Committee-
374/2017(P-1) dated 05-04-2019

Sir,

In reference to above and our previous Letter No.19 dated 09-04-2019, I am sending herewith the reminder of the Screening Report alongwith the fund requirement for Screening across channels/drains and IEC activities.

An early action for providing fund may please be ensured.

Thanking you,

Yours faithfully,

Executive Officer
Garulia Municipality

Executive Officer
Garulia Municipality

Encl: As stated above

Copy to:
The Director
State Urban Development Agency
ILGUS BHAVAN, H.C. Block, Sector-III
Bidhannagar, Kolkata-700106
for information and necessary action.

Executive Officer
Garulia Municipality

UD/00/2019/07734 28. 09/7/19

সুডা

SUDA

রাজ্য নগর উন্নয়ন সংস্থা

STATE URBAN DEVELOPMENT AGENCY

“ইলগাস ভবন”, এইচ-সি ব্লক, সেক্টর-৩, বিধাননগর, কলকাতা-৭০০ ১০৬, পশ্চিমবঙ্গ

“ILGUS BHAVAN”, H-C Block, Sector - III, Bidhannagar, Kolkata - 700 106, West Bengal

ক্রমিক নং SUDA- 50/2016/

তারিখ 05.07.2019

To

1. The Chairman/Chairperson, _____ Municipality
2. The Municipal Commissioner Kolkata Municipal Corporation
3. The Commissioner, Howrah/ Chandernagore Municipal Corporation
4. The Administrator, _____ Municipality

Sub: Review meeting on the progress of solid waste management activities in 42 Ganga towns of West Bengal to prevent Ganga pollution scheduled on 10.07.2019 at 12 noon in the conference hall of SUDA

Madam/Sir,

A review meeting on the progress of solid waste management activities to prevent pollution in 42 Ganga towns is scheduled on 10.07.2019 at 12 noon in the conference hall of State Urban Development Agency, ILGUS Bhawan, HC-Block, Sector-II, Salt Lake, Kolkata – 700106.

You are requested to kindly depute Joint Commissioner/ Deputy Commissioner/ Executive Officer and the Nodal Officer for SWM of your ULB to attend the meeting alongwith updated progress report as per format enclosed in the above mentioned venue, date and time.

Yours faithfully

Sd/-
(Director)

Encl: As stated above

SUDA- 50/2016/4505/1(6)

Date. 05.07.2019

Copy forwarded for kind information to:

1. Chief Executive Officer, KMDA - may kindly advise Chief Engineer (SWM) to remain present with relevant ongoing/ upcoming project details for Ganga towns.
2. Project Director, SPMG - may kindly advise concerned Officer to remain present with relevant ongoing/ upcoming project details for Ganga towns.
3. Joint Secretary, UD&MA Department, GoWB & Additional Director, SUDA
4. Secretary, MED – with request to kindly advice concerned Engineer to remain present with relevant project details.
5. PS to the Principal Secretary, UD&MA Department, GoWB
6. OSD, SUDA – with the request to book the Conference Hall and make necessary arrangement for refreshment.

Sd/- 5/7/19
(Director)

দূরভাষ : ২৩৫৮ ৬৪০৩ / ৫৭৬৭, ফ্যাক্স : ২৩৫৮ ৫৮০০

Tel : 2358 6403/5767, Fax : 2358 5800, E-mail : wbsudadir@gmail.com

Account Section : 2358 6408

List of Ganga Towns

S No.	Name of Town	District
1	Katwa	Bardhaman
2	Baidyabati	Hooghly
3	Bansberia	Hooghly
4	Bhadreshwar	Hooghly
5	Champdani	Hooghly
6	Chandannagar MC	Hooghly
7	Hooghly-Chinsurah	Hooghly
8	Konnagar	Hooghly
9	Rishra	Hooghly
10	Serampore	Hooghly
11	Uttarpara	Hooghly
12	Howrah MC + Bally	Howrah
13	Uluberia	Howrah
14	Kolkata MC	Kolkata
15	Murshidabad	Murshidabad
16	Behrampur	Murshidabad
17	Dhulian	Murshidabad
18	Jangipur	Murshidabad
19	Jiaganj-Azimganj	Murshidabad
20	Kalyani	Nadia
21	Nabadwip	Nadia
22	Santipur	Nadia
23	Chakdah	Nadia
24	Gayespur	Nadia
25	Krisnagar	Nadia
26	Kanchrapara	North 24 Parganas
27	Baranagar	North 24 Parganas
28	Barrackpore	North 24 Parganas
29	Bhatpara	North 24 Parganas
30	Garulia	North 24 Parganas
31	Halishahar	North 24 Parganas
32	Kamarhati	North 24 Parganas
33	Khardah	North 24 Parganas
34	Naihati	North 24 Parganas
35	Panihati	North 24 Parganas
36	Titagarh	North 24 Parganas
37	Haldia	Purba Medinipur
38	BudgeBudge	South 24 Parganas
39	Maheshtala	South 24 Parganas
40	Diamond Harbour	South 24 Parganas
41	Pujali	South 24 Parganas
42	North Barrackpore	North 24 Parganas