

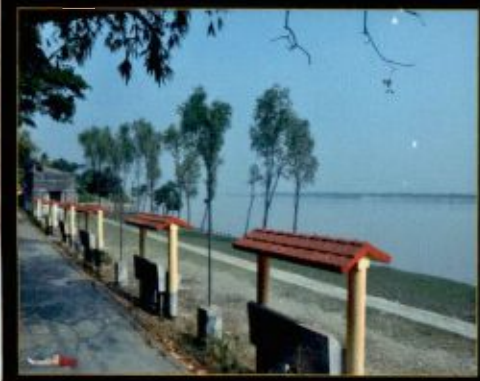

# Detail Project Report of HFA

for the year 2019-20



TAKI MAIN ROAD, TAKI, NORTH 24 PARGANAS, PIN - 743429

## Preface

Annual Implementation Plan(AIP) (for the year 2018-19) of Pradhan Mantri Awas Yojana(PMAY) aims at providing Housing For All(HFA) by 2022 when the nations completed 75 years of its independence.

The present scheme Housing for All under PMAY has appeared as a golden opportunity before those BPL/ EWS/LIG families who actually deserve to be provided with a house by 2022.

Total beneficiaries of the AIP are **528** Nos. projected for the year 2019-20. Total cost of the project is Rs. 1943.04 lakhs as per relevant department and PWD schedule of rates.



Somenath Mukherjee  
Chairman  
Taki Municipality

- Chairman  
TAKI MUNICIPALITY

## Definition

Affordable Housing Project:	Housing projects where 35% of the houses are constructed for EWS category
Beneficiary	A beneficiary family will comprise husband, wife and unmarried children. The beneficiary family should not own a pucca house (an all weather dwelling unit) either in his/her name or in the name of any member of his/her family in any part of India.
Carpet Area	Area enclosed within the walls, actual area to lay the carpet. This area does not include the thickness of the inner walls
Central Nodal Agencies	Nodal Agencies identified by Ministry for the purposes of implementation of Credit linked subsidy component of the mission
Economically Weaker Section (EWS):	EWS households are defined as households having an annual income up to Rs. 3,00,000 (Rupees Three Lakhs). States/UTs shall have the flexibility to redefine the annual income criteria as per local conditions in consultation with the Centre.
EWS House	An all weather single unit or a unit in a multi-storeyed super structure having carpet area of upto 30 sq. m. with adequate basic civic services and infrastructure services like toilet, water, electricity etc. States can determine the area of EWS as per their local needs with information to Ministry
"Floor Area Ratio" (FAR)/FSI	The quotient obtained by dividing the total covered area (plinth area) on all the floors by the area of the plot: $FAR = \frac{\text{Total covered area on all the floors} \times 100}{\text{Plot area}}$ If States/Cities have some variations in this definition, State/City definitions will be accepted under the mission
Implementing Agencies	Implementing agencies are the agencies such as Urban Local Bodies, Development Authorities, Housing Boards etc. which are selected by State Government/SLSMC for implementing Pradhan Mantri Awas Yojana - Housing for All (Urban) Mission.
Low Income Group (LIG):	LIG households are defined as households having an annual income between Rs.3,00,001 (Rupees Three Lakhs One) up to Rs.6,00,000 (Rupees Six Lakhs). States/UTs shall have the flexibility to redefine the annual income criteria as per local conditions in consultation with the Centre.
Primary Lending Institutions(PLI)	Scheduled Commercial Banks, Housing Finance Companies, Regional Rural Banks (RRBs), State Cooperative Banks, Urban Cooperative Banks or any other institutions as may be identified by the Ministry
Slum	A compact area of at least 300 population or about 60-70 households of poorly built congested tenements, in unhygienic environment usually with inadequate infrastructure and lacking in proper sanitary and drinking water facilities.
State Level Nodal Agencies (SLNAs)	Nodal Agency designated by the State Governments for implementing the Mission
Transfer of Development Rights (TDR)	TDR means making available certain amount of additional built up area in lieu of the area relinquished or surrendered by the owner of the land, so that he can use extra built up area himself in some other land.

# Project at a Glance

Name of the Town: TAKI Municipality

Name of the Project	Annual Implementation Plan (AIP) (2019-20)
Urban Local body	Taki Municipality
City	Taki
Slum Information	
Total number of areas and beneficiaries	Total 528 Nos of beneficiaries shall be benefitted covering 16 No of Wards.
Four Development vertical /options (as per PMY 2015)	<ol style="list-style-type: none"><li>1. "In situ" slum Redevelopment</li><li>2. Affordable Housing through Credit Linked Subsidy</li><li>3. Affordable Housing in Partnership</li><li>4. Subsidy for beneficiary-led individual house construction.</li></ol>

# Introduction

Housing is one of those basic social conditions that determine the quality of life and welfare of people and places. Rapid urbanization has placed remarkable strain on housing and service land. According to UN HABITAT by 2030, approximately 3 billion people, or above 401 per cent of the world's population, will need proper housing and access to basic infrastructure and services such as water and sanitation systems. This translates into the need to complete 96,150 housing units per day with serviced and documented land from now till 2030. However, ironically supply (especially in the developing world) is often limited by inadequate governance system/ human resource deficiencies/ institutions or regulations which are obsolete or lacking in capacity.

The Indian challenge is to place the reality of a recorded (Census 2011) rate of urbanization of 31.1% (377 million people) expected to house 600 million people by 2030 (up by 59% from 2011) with an expected urban housing shortage of 19 million; the slum population which is presently 66 million is projected at 105 million by 2017; the urban housing demand projected for the same year is as 88.78 million. In 2012 the Ministry of Housing & Urban Poverty Alleviation (MoHUPA) stated there was an undersupply of 18.78 million housing units, of which the economically weaker section (EWS) and Lower Income Group (LIG) constituted 95%. Whilst considering housing, it may be noted that Obsolescent houses (est. 2.82 million), as well as those with congestion (est. 18.42% of total households) have to be reckoned with in our Housing Demand.

To fulfill these needs, factors such as affordability of the buyers, development cost and selling price persistently influence the supply and demand in the housing sector. Based on the current situation, housing development is concentrated in the urban and sub-urban areas, where the purchasing power is higher and the market is extensive.

In order to address the current housing needs, both the Government and the private sector must play their respective roles to fulfill their social obligations especially to the low-income and economically weaker sections keeping in view limited public resources available and the heavy investments needed for creating housing infrastructure.

## **Housing for All:**

Access to housing facilities, is a basic human need, next only to food and clothing. Effectively, society as a whole and poor in particular, must have access to livelihoods, finance and technology as well as relevant capacities, knowledge and skills for habitat development in order to enjoy the 'right to shelter'.

In order to address issues related to housing and informal settlements, the governments should create an enabling environment through robust National/ State Housing Policies that will help to increase the supply of affordable housing. This call for working together of key stakeholders such as national and local government bodies, non-governmental organizations, financial institutions, as well as builders and private sector developers. This will enable well defined institutional and operational conditions in order to support the housing sector more effectively and, in doing so, contribute to the provision of affordable adequate Housing for All.

## Context of preparation of Housing for All Plan of Action:

The Government of India's transformation programme is to "raise living standard of low income households" for which Ministry of Housing and Urban Poverty Alleviation (MoHUPA) had come up with the "National Housing and Habitat Policy (NUHHP) 2007, a precursor to the current 'Housing for all' by 2022. Several steps would be taken under the Mission to overcome problems pertaining to housing specially involving the poor and the ultra-poor.

An important part here is to ensure that only eligible recipient received housing aid, and that they be identified at their current location through a web portal which has a state wide database for capturing on low-income households, with arrangements for constant monitoring and updation.

In order to address the current housing needs, both the Government and the private sector must play their respective roles to fulfill their social obligations especially to the low-income and economically weaker sections keeping in view limited public resources available and the heavy investments needed for creating housing infrastructure.

Accordingly, the Ministry of Housing and Urban Poverty Alleviation (MoHUPA) has launched "Housing for All" Mission through Pradhan Mantri Awas Yojana (PMAY) for Urban Area to be implemented during 2015-2022 as a Centrally Scheme (except for the component of Credit Linked subsidy, which will be implemented as a State Sponsored Scheme. The Mission would provide central assistance to implementing agencies through State & UTs for providing housing to eligible families / beneficiaries by 2011. The Mission seeks to address the housing requirement of urban poor including slum dwellers for which all the states are required to prepare 'Housing for All of Action' with Annual Implementation Plans. Mission will assist State /cities in carrying out the activities for preparation of Housing for All Plan of Action (HFAPoA) under capacity building and A & OE funds. HFAPoA addresses urban poor who may not necessarily be slum dwellers.

All 4041 statutory towns as per Census 2011 with focus on 500 class I cities would be covered in three phases as follows:

- Phase I (April 2015- March 2017) to cover 100 Cities selected from States /UTs as per their willingness.
- Phase II (April 2017 – March 2019) to cover additional Cities

Ministry, however, will have flexibility regarding inclusion of Additional cities in earlier. The mission seeks to address the housing requirement of urban poor including slum dwellers through following programme verticals giving option to beneficiaries, ULBs and State Governments. These verticals are:

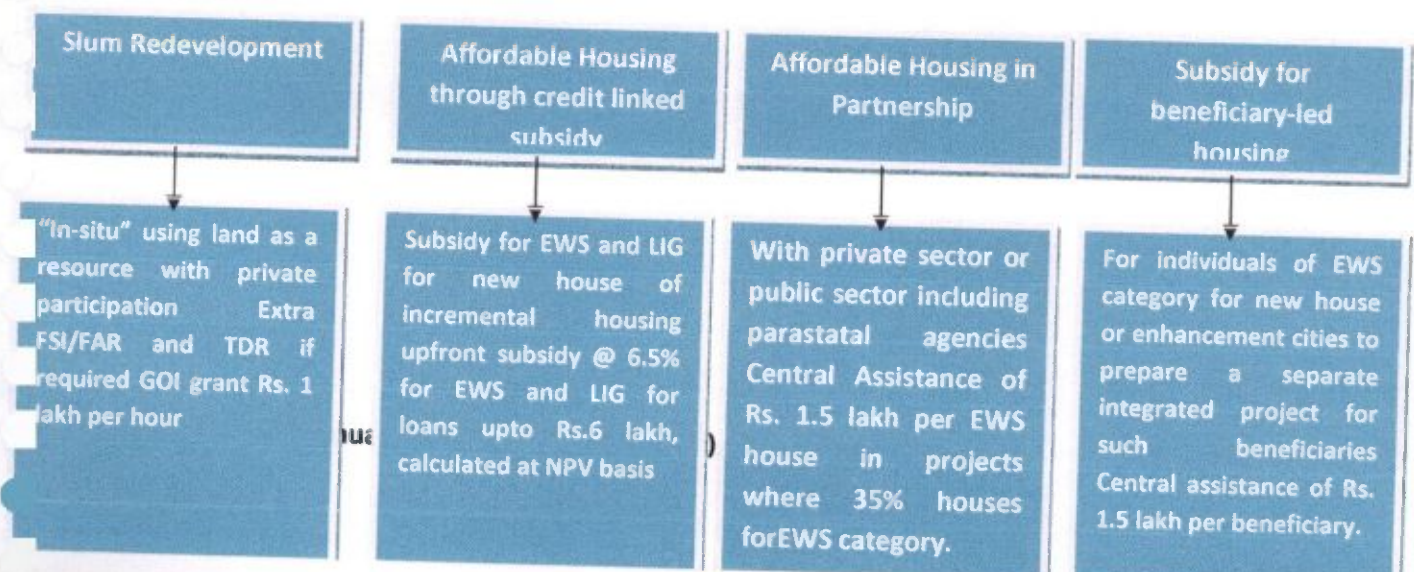

# Aims and Objectives

## Aim:

The aim of this Annual Implementation Plan is to create an enabling environment for providing "Affordable Housing for All" with special emphasis on EWS/LIG and other vulnerable sections of society. The Action Plan further aims to promote house for all mainly through Beneficiary Led Construction (BLC) vertical addressing the shortage of adequate and affordable housing.

## Objectives:

- Reduce housing shortage for Urban Poor (both residing in slum and non-slum areas).
- Ensure an efficient and regular supply of affordable housing unit to satisfy / meet growing demand in the city.
- Ensure that all dwelling units have access to basic physical and social infrastructure like sanitation facilities, drinking water, electricity, roads and other livelihood infrastructure.
- Encourage private developers of all scales in construction of BPL/EWS/LIG categories of houses.
- Create rental housing as transit accommodation for migrants to urban areas.

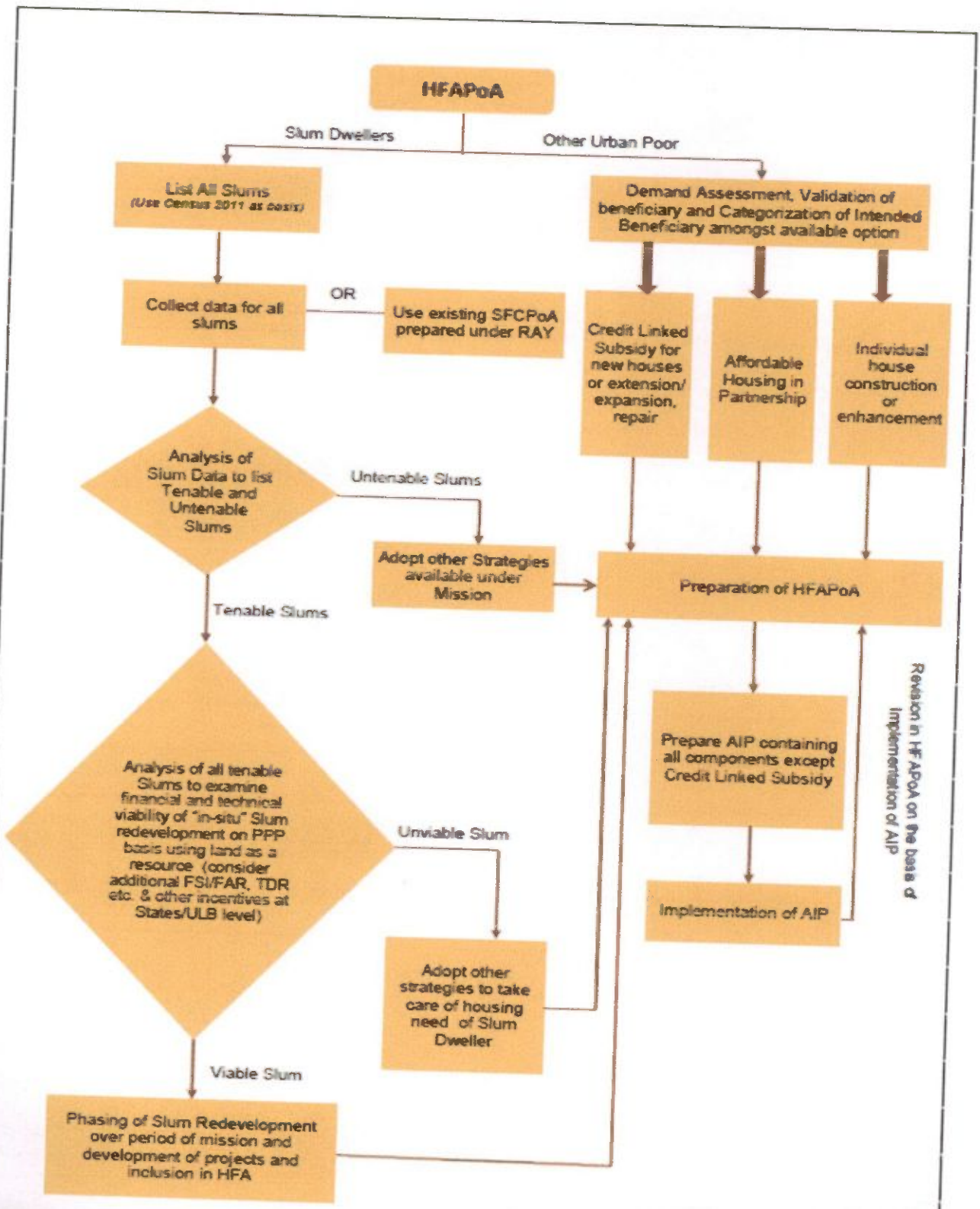



# TAKI MUNICIPALITY BASE MAP

P.O.-TAKI, PIN NO. - 743429

P.S.-HASNABAD, SUB DIVISION - BASIRHAT  
DIST.-NORTH 24 PGS.

MUNICIPALITY WARD  
SHOWN IN  
DIFFERENT COLOUR



## REFERENCES

- MUNY BOUND LINE
- KHAL, RIVER
- ROAD
- RAIL LINE
- MANDIR
- MASZID
- PUCCA STRUC
- SWICE GATE



## NOTE

ESTABLISHED TARI MURY 1ST APRIL 1963  
 AREA OF MUNICIPALITY 12.965 SQ. KM.  
 NOS. OF WARDS 16 NOS  
 MOZZA - 6 NOS  
 POPULATION AS PER CENSUS. REP. 1981) 26-671 NOS  
 " " " " " 1997) 30-420 " "  
 POPULATION ( " " " " 2001) 37305 "

### Slum Details

Unit/ Score			in Sq Mt	in no.	in no.	in no.	in no.	in no.
Ward Number	Slum Code	Slum Name	Total Area	General	SC	ST	OBC	Minority
1	20001	Paschim Beonketi Sardar Para	70000	360	53	0	0	10
1	20002	Paschim Beonketi Ghosh Para	70000	420	25	0	0	4
1	20003	Jalalpur Mondalpara And Dafadar Para	69300	371	24	0	0	0
1	20004	Jalalpur Daspara	21700	150	3	0	0	0
2	20005	Saidpur Nikeri Para	60000	320	25	0	0	23
2	20006	Saidpur Rajbansi Para	7100	50	8	0	0	0
2	20007	Saidpur Bazi Para	70500	370	13	0	0	0
2	20008	Saidpur Jela Para	76500	385	53	0	0	0
3	20009	Taki Rajbansi And Kumar Para	6400	50	8	0	0	0
3	20010	Taki Debibabur Bagan	16200	110	7	0	0	3
3	20011	Taki Das Para	88000	470	9	0	0	0
3	20012	Taki Uttar Pally	15500	110	6	0	0	5
4	20013	Taki Chandra Para And Adhikary Para	5000	35	9	0	0	3
4	20014	Taki Biswaspara	48500	327	4	0	0	7
5	20015	Taki Dargatala Para	6200	50	0	0	0	0
5	20016	Taki Jelepara	14200	70	35	0	0	1
5	20017	Taki Dargatala	45000	280	4	1	0	0
5	20018	Taki Dakshin Rari Para	12000	76	2	0	0	0
5	20019	Taki Char Para	27500	180	2	0	0	0
6	20020	Taki Agradani Dakshin Rari Kahar Para	16100	117	6	0	0	0
6	20021	Taki Agradani Kahar Para	27500	173	36	0	0	1
6	20022	Taki Natun Kahar Para	10000	63	12	0	0	0
6	20023	Taki Das Para	88000	493	5	0	0	40
6	20024	Rajipur Char Para	34000	275	0	0	0	10
7	20025	Hospital And Kahar Para	33100	201	20	0	0	1
7	20026	Taki Kahar Para	38300	191	49	0	0	0
7	20027	Thuba Rishidas Para	32500	161	48	0	0	1
7	20028	Thuba Rishidas Para	50000	240	70	0	0	0
8	20029	Taki Station Para Natun Colony	92300	633	131	0	0	5
8	20030	Rail Station Para	61700	420	55	0	0	17
8	20031	Thuba Guli Para	61200	383	79	0	0	4
8	20032	Thuba Rishidas Para	43000	221	64	0	0	15
9	20033	Jugia Rishidas Para	41600	217	58	0	0	0
9	20034	Jugia Das Para	15000	91	49	0	0	0
9	20035	Pul Para Thuba	28800	227	0	0	0	1
10	20036	Dhopa Para	76000	561	17	0	0	2

10	20037	Char Para Gaji Para	38000	290	14	0	0	1
10	20038	Kaul Para	12100	95	0	0	0	1
11	20039	Laskar Nagar Para	76000	700	3	0	0	1
11	20040	Ramkrishna Pally	25000	100	127	0	0	0
11	20041	Laskar Nagar Hashnabad	37200	275	10	0	0	5
11	20042	Naval Para	49600	299	41	0	0	0
11	20043	Paul Para Rail Colony	73200	563	38	0	0	6
11	20044	Hatath Colony	71900	579	104	0	0	2
12	20045	Khalpar Para	70000	405	83	2	0	8
12	20046	Nikeri Para And Gazipara	58100	542	2	0	0	11
12	20047	Binodh Colony	40200	238	100	0	0	2
12	20048	Idga Para	20000	177	4	0	0	39
13	20049	Rajipur Nikari Para	30000	227	0	0	0	0
13	20050	Baro Masjid Para	24000	180	0	0	0	1
13	20051	Puratan Kalibari Para	24500	185	3	0	0	1
14	20052	Debi Cinema Para	57500	391	18	0	0	1
14	20053	Santi Colony	10000	14	70	0	0	1
14	20054	Badamtala Para	49200	415	1	0	0	1
14	20055	Badamtala Pukur Para	59400	481	37	1	0	1
14	20056	Barma Colony	40200	282	83	0	0	0
15	20057	Rail Pukur Para	20400	145	45	0	0	0
15	20058	Hashnabad Das Para	10000	72	23	0	0	0
15	20059	Das Para	20000	167	12	1	0	0
15	20060	Rail Pukur Para	48500	383	47	0	0	0
16	20061	Binodh Colony Jele Para	30000	169	79	1	0	1
16	20062	Hashnabad Nikari Para	68000	616	4	0	0	0
16	20063	Binodh Colony Jele Para	54400	345	79	1	0	0
16	20064	Adhikary Para And Puratan Bazar Para	20000	140	35	0	0	0
16	20065	Nikari Para	58500	432	3	0	0	0
16	20066	Mansingha Road	52300	378	56	1	0	1
16	20067	Suvash Colony	51400	436	38	1	0	1

<b>Total</b>			<b>2778300</b>	<b>18572</b>	<b>2148</b>	<b>9</b>	<b>0</b>	<b>238</b>
--------------	--	--	----------------	--------------	-------------	----------	----------	------------

**Annexure 6**

**(Para 8.6 & Para 14.4 of the Guidelines)**

**Summary Sheet for Annual Implementation Plan (AIP) for the year 2018-19**

Admissible Components	Target for Year 2015 - 16	Achievement for Year 2015 -16	Target for Year * 2016 -17	Achievement for Year* 2016 -17	Target for Year** 2018-19	Target for Year** 2019-20	Remaining Targets as per HFAPoA
<b>A. Beneficiary-led Construction</b>							
• New Houses	148	148			600	528	1401
• Enhancement							
• Sub Total (A)					600	528	1401
<b>B. In-Situ Slum Rehabilitation with Participation of Private Sector</b>	NA						
• Number of Slums							
• Number of Households (B)							
<b>C. Affordable Housing in Partnership (EWS Category) ©</b>	NA						
<b>D. Credit linked subsidy</b>							
• EWS Households							
• LIG Households							
• Sub Total (D)							
<b>E. Total (A+B+C+D)</b>					600	528	1401
<b>Note: * The year preceding to the year of this AIP</b> <b>** The year for which Annual Implementation Plan has been prepared</b>							

**I. Subsidy for Beneficiary-led Individual House Construction or Enhancement**

**I. Beneficiary-led Individual House Construction or Enhancement**

Year *	No. of Beneficiaries		Resource Mobilization (Rs. in Crores)						
	New Housing	Enhancement of existing House	New Housing	Enhancement of existing housing	Total Cost	Central Share	State share	Beneficiary Share	ULB share (if applicable)
2015-16									
2016-17									
2018-19	528	0	528	0	1943.04	792.00	1019.04	132.00	0.00
2018-19									
2019-20									
2020-21									
2021-22									
Total	528	0	528	0	1943.04	792.00	1019.04	132.00	0.00

Note: \* Please fill the projected figures for the year for which AIP is proposed and actual figures of achievement for preceding years

\*\* Total Cost per dwelling unit Rs. 3.68 /- Lakhs

**II. Slum Rehabilitation of Slum Dwellers with Participation of Private Sector**

**II. Slum Rehabilitation through Participation of Private Sector**

Year *	No. of Slums	No. of Beneficiaries	Resource Mobilization (Rs. in Crores)				
			Total Cost	Central Share	State share	Beneficiary Share	ULB share (if applicable)
2015-16							
2016-17							
2018-19			N/A				
2018-19							
2019-20							
2020-21							
2021-22							
Total							

Note: \* Please fill the projected figures for the year for which AIP is proposed and actual figures of achievement for preceding years

**III. Affordable Housing in Partnership with Public & Private Sectors**

Year *	Number of Projects	No. of Beneficiaries	Resource Mobilization (Rs. in Crores)			
			Total Project Cost (AHP)	Central Share	State Share	ULB Share (if applicable)
2015-16						
2016-17						
2018-19			N/A			
2018-19						
2019-20						
2020-21						
2021-22						
Total						

Note: \* Please fill the projected figures for the year for which AIP is proposed and actual figures of achievement for preceding years

#### IV. Affordable Housing through Credit Linked Subsidy

Year *	Credit Link Subsidy Availed for	Number of Beneficiaries Availed Loan		Resource			
				Mobilization (Rs. in Crores)		Estimated Interest Subsidy Availed	
		EWS	LIG	EWS	LIG	EWS	LIG
2015-16	New Housing	Nil	Nil	Nil	Nil	Nil	Nil
	Enhancement (Existing Housing)	Nil	Nil	Nil	Nil	Nil	Nil
2016-17	New Housing	Nil	Nil	Nil	Nil	Nil	Nil
	Enhancement (Existing Housing)	Nil	Nil	Nil	Nil	Nil	Nil
2018-19	New Housing	Nil	Nil	Nil	Nil	Nil	Nil
	Enhancement (Existing Housing)	Nil	Nil	Nil	Nil	Nil	Nil
2019-20	New Housing	Nil	Nil	Nil	Nil	Nil	Nil
	Enhancement (Existing Housing)	Nil	Nil	Nil	Nil	Nil	Nil
2020-21	New Housing						
	Enhancement (Existing Housing)						
2021-22	New Housing						
	Enhancement (Existing Housing)						
	<b>Total</b>	Nil	Nil	Nil	Nil	Nil	Nil

Note: \* Please fill the projected figures for the year for which AIP is proposed and actual figures of achievement for preceding years

**DECLARATION**

I, the undersigned, declare to your good self that **Annexure 7C** which is submitted along with the PMAY-HFA 2019-20 DPR, **containing Caste category & Gender** for Beneficiary Led Constructions (BLC) that there will be no change therein. We also declare that we will strictly adhere to the PMAY-HFA(U) guidelines.

Signature of Executive Officer

.....Municipal Corporation  
/ Municipality



Signature of Mayor/Chairman

.....Municipal Corporation  
/ Municipality

— Chairman  
TAKI MUNICIPALITY



## Executive Summary

Project Details			
1	Name of the State:	:	<b>West Bengal</b>
2	Name of the District:	:	<b>North 24 Parganas</b>
3	Name of the City:	:	<b>Taki Municipality</b>
4	Project Name:	:	<b>HFA-Taki -2019-20</b>
5	Project Cost (Rs. in Lakhs)	:	<b>2,137.34</b>
6	Central Share (Rs. in Lakhs)	:	<b>792.00</b>
7	State Share (Rs. in Lakhs)	:	<b>1,116.19</b>
8	ULB Share (Rs. in Lakhs)	:	<b>97.15</b>
9	Beneficiary share (Rs. in Lakhs)	:	<b>132.00</b>
10	Total Infrastructure Cost (Rs. in Lakhs)	:	<b>194.30</b>
11	Percentage of Infrastructure Cost of Housing Cost	:	<b>10</b>
12	Infrastructure Cost per Dwelling Unit (Rs. in Lakhs)	:	<b>0.368</b>
13	Year of Implementation	:	<b>2019-20</b>
14	Component Housing Construction	:	<b>Beneficiary Led Construction (BLC)</b>
15	SOR Adopted	:	<b>PWD (WB) w.e.f 1.11.17 with current corrigendum</b>

### Project Contributions (Physical + Financial) (Rs. in Lakh)

Sl. No.	Scheme Component	Type	Qty	Unit	Rate (in Rs/Unit)	Proposed Project Cost (In Lakh)	Appraised Project Cost (In Lakh)	Central Share (Rs. 1.5Lakh/ DU)	State Govt. Share (Rs.1.93 Lakh/DU)	ULB Share	Beneficiaries Share @ 0.25 Lakh/DU)
<b>A. HOUSING</b>											
1	New in-situ										
	Single Storied Units	BLC	528	NOs	368000.00	1,943.04	1,943.04	792.00	1,019.04		132.00
<b>Total Housing Cost Sub Total (A)</b>						1,943.04	1,943.04	792.00	1,019.04		132.00
<b>B. INFRASTRUCTURE</b>											
Sl	Scheme Component	Type	Qty	Unit	Rate (in Rs/Unit)	Proposed Project Cost (In Lakh)	Appraised Project Cost (In Lakh)	Central Share (Rs. in Lakh)	State Govt. Share (@50% ) (in Lakh)	ULB Share (@50% ) (in Lakh)	Beneficiaries Share (in Lakh)
<b>1. ROADS</b>											
	Construction of C.C road	A type	4024.20	Sq mtr	1207.00	4857.21		0.00	2428.61	2428.60	Nil

Construction of C.C road	B type	4540	sqm tr	1070.00	4857.80		0.00	2428.90	2428.90	Nil
--------------------------	--------	------	--------	---------	---------	--	------	---------	---------	-----

**2. WATER SUPPLY**

NIL

**3. STORM WATER DRAINS**

Construction of storm water drainage	A Type	590	Mtr	5511.00	3251.49		0.00	1625.74	1625.74	Nil
Construction of storm water drainage	B Type	880	Mtr	3679.00	3237.52		0.00	1618.76	1618.76	Nil
Construction of storm water drainage	C Type	128 2.7	Mtr	2515.00	3225.99		0.00	1612.99	1612.99	Nil
<b>Total Infrastructure Cost Sub Total (B)</b>					19430.02			9715.01	9715.01	Nil
<b>GRAND TOTAL (A+B)</b>					21373.06		792.00	10734.05	9715.01	132.00

Md. Taki Hossain

Signature of the ULB level  
Competent Technical officer

Name & Designation: Sub-Asstt. Engineer  
TAKI MUNICIPALITY

Fax No:

Telephone No: 9979157791

E-mail: hossainj993@gmail.com

Signature of the State level Competent Technical  
Officer

Name & Designation: Chief Engineer, MeDte, GoWB  
Bikash Bhavan, South Block, 1<sup>st</sup> Floor, Salt lake, Kol-91

Fax No:

Fax No.: 033-23375474

Telephone No.: 033-23371331

E-mail: ce\_medte@yahoo.c

Signature  
Director(SUDA)

Signature of the Mayor/ Chairperson/Administrator  
Taki Municipality

Chairman  
TAKI MUNICIPALITY

Name & Designation: Debararati Duta Gupta  
Director, SUDA

Fax No: 033-23585767

Telephone No: 033-23585767

E-mail: [wbsudadir@gmail.com](mailto:wbsudadir@gmail.com)

Name & Designation: Somenath  
Mukherjee, Chairman, Taki Municipality

Fax No:

Telephone No: 03217233324

E-mail: [cmoftm@gmail.com](mailto:cmoftm@gmail.com)

(Para 8.6 &amp; Para 14.4 of the Guidelines)

## Summary Sheet for Annual Implementation Plan (AIP) for the year 2018-19

Admissible Components	Target for Year 2015 -16	Achievement for Year 2015 -16	Target for Year* 2016 -17	Achievement for Year* 2016 -17	Target for Year** 2017-18	Achievement for Year* 2017-18	Target for Year** 2018-19	Achievement for Year* 2018-19	Target for Year** 2019-20	Remaining Targets as per HFAPOA
A. Beneficiary-led Construction		148	0	0	0	0	600	600	528	1401
• New Houses		148	0	0	0	0	600	600	528	1401
• Enhancement										
• Sub Total (A)		148	0	0	0	0	600	600	528	1401
with										
Participation of Private										
• Number of Slums	0	0	0	0	0	0	0	0	0	
• Number of Households (B)	0	0	0	0	0	0	0	0	0	
C. Affordable Housing in Partnership										
D. Credit linked subsidy										
• EWS Households										
• LIG Households										
• Sub Total (D)										
E. Total (A+B+C+D)										

Note: \*The year preceding to the year of this AIP

\*\* The year for which Annual Implementation Plan has been prepared

**I. Subsidy for Beneficiary-led Individual House Construction or Enhancement**

<b>I. Beneficiary-led Individual House Construction or Enhancement</b>									
		Resource Mobilization (Rs. in Crores)							
Year *	No. of		New Housing	Enhancement of existing housing	Total Cost	Central Share	State share	Beneficiary Share	ULB share (if applicable)
	New Housing	Enhancement of existing House							
2015-16	148	0	5.45	0	5.45	2.22	2.86	0.37	NA
2016-17		0	0.00	0	0.00	0.00	0.00	0.00	NA
2017-18		0	0.00	0	0.00	0.00	0.00	0.00	NA
2018-19	600	0	22.08	0	22.08	9.00	11.58	1.50	NA
2019-20	528	0	19.43	0	19.43	7.92	10.19	1.32	NA
2020-21		0	0.00	0	0.00	0.00	0.00	0.00	NA
2021-22		0	0.00	0	0.00	0.00	0.00	0.00	NA
<b>Total</b>	<b>1276</b>	<b>0</b>	<b>46.96</b>	<b>0</b>	<b>46.96</b>	<b>19.14</b>	<b>24.63</b>	<b>3.19</b>	<b>NA</b>

Note: \* Please fill the projected figures for the year for which AIP is proposed and actual figures of achievement for preceding years

\*\* Total Cost per dwelling unit Rs. 3.68 /- Lakhs

**II. Slum Rehabilitation of Slum Dwellers with Participation of Private Sector**

Year *	No. of Slums	No. of Beneficiaries	Resource Mobilization (Rs. in Crores)				ULB share (if applicable)
			Total Cost	Central Share	State share	Beneficiary Share	
2015-16	N.A	N.A	N.A	N.A	N.A	N.A	N.A
2016-17	N.A	N.A	N.A	N.A	N.A	N.A	N.A
2017-18	N.A	N.A	N.A	N.A	N.A	N.A	N.A
2018-19	N.A	N.A	N.A	N.A	N.A	N.A	N.A
2019-20	N.A	N.A	N.A	N.A	N.A	N.A	N.A
2020-21	N.A	N.A	N.A	N.A	N.A	N.A	N.A
2021-22	N.A	N.A	N.A	N.A	N.A	N.A	N.A
Total	N.A	N.A	N.A	N.A	N.A	N.A	N.A

Note: \* Please fill the projected figures for the year for which AIP is proposed and actual figures of achievement for preceding years

III. Affordable Housing in Partnership with Public & Private Sectors							
Year *	Number of Projects	No. of Beneficiaries	Total Project Cost (AHP)	Resource Mobilization (Rs. in Crores)			ULB Share (if applicable)
				Central Share	State Share	ULB Share (if applicable)	
2015-16	N.A	N.A	N.A	N.A	N.A	N.A	N.A
2016-17	N.A	N.A	N.A	N.A	N.A	N.A	N.A
2017-18	N.A	N.A	N.A	N.A	N.A	N.A	N.A
2018-19	N.A	N.A	N.A	N.A	N.A	N.A	N.A
2019-20	N.A	N.A	N.A	N.A	N.A	N.A	N.A
2020-21	N.A	N.A	N.A	N.A	N.A	N.A	N.A
2021-22	N.A	N.A	N.A	N.A	N.A	N.A	N.A
Total	N.A	N.A	N.A	N.A	N.A	N.A	N.A

Note: \* Please fill the projected figures for the year for which AIP is proposed and actual figures of achievement for preceding years

**IV. Affordable Housing through Credit Linked Subsidy**

Year *	Credit Link Subsidy Availed for	Number of Beneficiaries Availed Loan		Resource Mobilization (Rs. in Crores)		
		EWS	LIG	Estimated Loan		Estimated Interest Subsidy Availed
				EWS	LIG	
2015-16	New Housing Enhancement (Existing Housing)			NO TARGET FOR THIS YEAR		
2016-17	New Housing Enhancement (Existing Housing)			NO TARGET FOR THIS YEAR		
2017-18	New Housing Enhancement (Existing Housing)			NO TARGET FOR THIS YEAR		
2018-19	New Housing Enhancement (Existing Housing)			NO TARGET FOR THIS YEAR		
2019-20	New Housing Enhancement (Existing Housing)			NO TARGET FOR THIS YEAR		
2020-21	New Housing Enhancement (Existing Housing)			NO TARGET FOR THIS YEAR		
2021-22	New Housing Enhancement (Existing Housing)			NO TARGET FOR THIS YEAR		
	<b>Total</b>			<b>NO TARGET FOR THIS YEAR.</b>		

Note: \* Please fill the projected figures for the year for which AIP is proposed and actual figures of achievement for preceding years



**Annexure 7C**

**(Para 14.5 of the Guidelines)**

**Format for Project under Beneficiary Led Construction Or Enhancement**

1	Name of the State:	:	<b>West Bengal</b>						
2	Name of the District:	:	<b>North 24 Parganas</b>						
3	Name of the City:	:	<b>Taki</b>						
4	Project Name:	:	<b>Hfa-Taki -2019-20</b>						
5	Project Code:	:	<b>19801719034N0</b>						
6	State Level Nodal Agency:	:	<b>State Urban Development Agency</b>						
7	Implementing Agency/ ULB	:	<b>Taki Municipality</b>						
8	Date of Approval by State Level Sanctioning and Monitoring Committee (SLSMC)	:							
9	No. of location covered in project: No of Slum Area Covered & No of Non Slum Area Covered	:	Name of Location	No. of beneficiaries	Whether Slum / Non-Slum	If Slum, then Slum type	If slum, whether it gets completely rehabilitated		
		:	TAKI MUNICIPAL AREA	528	Covering both Slum & Non-Slum area	Notified	No		
10	Project Cost (Rs. In Lakhs)	:							
11	No. of beneficiaries covered in the project	:	GEN	SC	ST	OBC	Total	Minority	Person with Disability
		:	230	165	0	133	528	98	
12	Whether beneficiary have been selected as PMAY Guidelines?	:	<b>Yes</b>						
13	No. of Houses constructed / acquired. Please specify ownership (Any of these)	:	Joint	Female	Male	Transgender			
		:	0	146	382	0			
14	No. of beneficiaries covered in the project	:	Male	Female	Transgender				
		:	382	146					
15	Whether it has been ensured that selected beneficiaries have rightful ownership of the land ?	:	<b>Yes</b>						
16	Whether building plan for all houses have been Approved?	:	<b>Yes</b>						
17	i. GoI grant required (Rs. 1.5 lakh per eligible beneficiary)	:	<b>792.00</b>						

	(Rs. in Lakhs)	
	ii. State grant, (Rs. in Lakhs)	1,116.19
	iii. ULB grant (Rs. in Lakhs)	97.15
	iv. Beneficiary Share (Rs. in Lakhs)	132.00
	v. Total (Rs. in Lakhs)	2,137.34
18	Whether technical specification / design for housing have been ensured as per Indian Standards / NBC/ State Norms?	Yes
19	Whether it has been ensured that balance cost of construction is tied up with State Grant, ULB Grant & Beneficiary Share ?	Yes
	Whether trunk and line infrastructure is existing or being provisioned ?	
	i. Water Supply	Yes
	ii. Sewerage	No
	iii. Road	Yes
	iv. Storm Water Drain	Yes
	v. External Electrification	No
	vi. Solid Waste Management	No
	vii. Any Other	No
	viii. In case, any infrastructure has not been proposed, reason thereof.	No
20	Whether disaster (earthquake, flood, cyclone, landslide etc.) resistant features have been adopted in concept, design and implementation of the project ?	Yes
21	Whether Demand Survey Completed for entire city ?	Yes
22	Whether City-wide integrated project havebeen formulated ? If not reasons thereof ?	Yes
23	Whether validation with SECC data for housing condition conducted ?	Yes
24	Whether Direct Benefit Transfer (DBT) of fund to individual bank account of beneficiary ensured in the project ?	Yes

25	Whether there is provision in DPR for tracking/monitoring the progress of individual houses through geo-tagged photographs ?	Yes
26	Whether any innovation/cost effective / Green technology adopted in the project?	Yes
27	Comments of SLAC after techno economic appraisal of DPR	Project covers the most needy beneficiaries
28	Project brief including any other information ULB/State would like to furnish	The project covers all wards
29	Project Submission Date to SLSMC	

It is hereby confirmed that State/UT and ULB have checked all the beneficiaries as per guidelines of HFA. It is also submitted that no beneficiary has been selected for more than one benefit under the Mission including Credit Linked Subsidy Scheme (CLSS) component of the Mission.

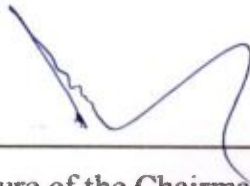

Signature of the Chairman  
Taki Municipality

*Chairman*  
**TAKI MUNICIPALITY**

Signature

Chief Engineer  
M.E Dte, GoWB

Signature

(Director, SUDA)

Signature

(Secretary, UD & MA Department, GoWB)

**DETAILED ESTIMATE FOR THE CONSTRUCTION OF SINGLE UNIT DWELLING HOUSE**

**Pradhan Mantri Awas Yojana Housing For All (Urban)**

Total Covered Area- 32.18 sq.m (With Electrical Works)

Reference of Schedule of Rates : PWD (W.B.), Schedule of Rates Building & Sanitary w.e.f-01.07.2014 & Corrigenda  
/24 Pgs (N & S)/ Kalyani Sub Div.)

(Kolkata

Floor Area 25.37 sqm

SL No	Description of Works	Quantity	Unit	Rate (Rs.)	Amount (Rs.)
1	Earthwork in excavation in foundation trenches or drains, in all sorts of soil ( including mixed soil but excluding laterite or sandstone) including removing spreading or stacking the spoils within a lead of 75 m as directed including trimming the sides of trenches, levelling, dressing and ramming the bottom, bailing out water etc. as required complete. a) Depth of excavation not exceeding 1500mm. <b>SOR, PWD, P-1, I -2 a</b>	13.000	%cu.m	12047.00	1566.11
2	Earth work in filling in foundation trenches or plinth with good earth in layers not exceeding 150 mm. including watering and ramming etc. layer by layer complete.( Payment to be made on the basis of measurement of finished quantity of work ) a) With earth obtained from excavation of foundation. <b>SOR, PWD, P-1, T/3 a</b>	11.120	%cu.m	7831.00	870.81
3	Supplying Laying Polithin Sheets etc. <b>SOR, PWD, P-45, T - 13</b>	22.000	sqm	25.00	550.00
4	Cement concrete with graded Stone ballast (40 mm.) excluding shuttering.a) In ground floor and foundation.6 : 3 : 1 proportion Pakur variety <b>SOR, PWD, Page 24 ; Item -10 a</b>	3.500	cu.m.	5823.00	20380.50
5	25 mm. thick damp proof with cement concrete (4:2:1) (with graded stone aggregate 10 mm. Normal size) and painting the top surface with a coat of bitumen using 1.7 kg. per sq.m. including heating the bitumen and cost and carriage of all materials complete. <b>SOR, PWD, P-45, T-12</b>	6.810	sqm,	297.00	2022.57
6	Brick work with 1st class bricks in cement mortar (6:1) a) In foundation and plinth. b) In super structure <b>SOR, PWD, P-29, T -22(a), (b)</b>	10.430 15.240	cum cum	5719.00 5943.00	59649.17 90571.32
7	125mm thick brick work with 1st. class bricks in cement mortar (4:1). a) In ground floor <b>SOR, PWD, P-73, I -29</b>	23.220	sq.m.	783.00	18181.26
8	Ordinary Cement concrete (mix 1:1.5:3) with graded stone chips (20 mm nominal size) excluding shuttering and reinforcement if any, in ground floor as per relevant IS codes. (i) Pakur Variety <b>SOR, PWD, P-14, T -7(i)</b>	3.940	cu.m.	6851.66	26995.54
9	Reinforcements for reinforced concrete work in all sorts of structures including distribution bars, stirrups, binders etc. including supply of rods, initial straightening and removal of loose rust (if necessary), cutting to requisite length, hooking and bending to correct shape, placing in proper position and binding with 16G black annealed wire at every intersection. complete as per drawing and direction. (a) For works in foundation, basement and upto roof of ground floor / upto 4m. (i) Tor steel/Mild steel. <b>SOR, PWD, P-27, T -15(i)</b>	0.309	MT	60705.93	18775.74
10	Hire and labour charges for shuttering with centring and necessary staging upto 4 m. using approved stout props and thick hard wood planks of approved thickness with required bracing for concrete slabs, beams, columns, lintels curved or straight including fitting, fixing and striking out after completion of works. (upto roof of ground floor). (When the height of a particular floor is more than 4 m. the equivalent floor ht. shall be taken as 4 m. and extra for works beyond the initial 4 m. ht. shall be allowed under 12(e) for every 4 m. or part thereof.) <b>SOR, PWD, P-66, T -12(a)</b> 25 mm. to 30 mm. thick wooden shuttering as per decision & direction of Engineer-in-charge. Ground Floor	37.063	M <sup>2</sup>	360.00	13342.68

	Description of Works	Quantity	Unit	Rate (Rs.)	Amount (Rs.)
11	Plaster ( to wall, floor, ceiling etc.) with sand and cement mortar including rounding off or chamfering corners as directed and raking out joints or roughening of concrete surface, including throating, nosing and drip course where necessary . In ground floor. A) With 6:1 cement mortar. a) Inside wall -20 mm thick plaster <b>SOR, PWD, P-151, T -2 (i)(b)</b> b) Out side Wall, 15mm th. <b>SOR, PWD, P-151, I -2 (i)(c)</b> B)10mm th ceiling plaster (4:1) <b>SOR, PWD, P-151, I -2 (i)(c)</b>	116.940	sq.m.	181.00	21166.14
		111.950	sq.m.	156.00	17464.20
		23.330	sq.m.	140.00	3266.20
12	Neat cement punning about 1.5mm thick in wall, dado, window, sills, floor, drain etc. <b>SOR, PWD, P-152, I -8</b>	26.700	sq.m.	38.00	1014.60
13	Artificial stone in floor,dado, staircase etc. with cement concrete (4:2:1) with stone chips laid in panels as directed with topping made with ordinary or white cement (as necessary) and marble dust in proportion (2:1) including smooth finishing and rounding off corners and including application of cement slurry before flooring works, using cement @ 1.75 kg./sq.m. all complete including all materials and labour. In ground floor. 3 mm. thick topping (High polishing grinding on this item is not permitted) with ordinary cement. 20mm thick <b>SOR, PWD, P-40, I -3 (i)</b>	26.490	sq.m.	265.00	7019.85
14	Supplying, fitting & fixing MS clamp for fixing door and window frame made of flat bent bar, end bifurcated, fixed in cement concrete with stone chips (4:2:1)a fitted and fixed omplete as per direction. 40mm x 6mm x 125 mm length. (Cost of cement concrete will be paid separately) <b>SOR, PWD, P-90, I -18 (c)</b>	34	each	22.00	748.00
15	Wood work in door and window frame fitted and fixed complete including a protective coat of painting at the contact surface of the frame other Local wood <b>SOR, PWD, P-85, T -1(i)</b>	0.213	cu.m.	46171.00	9834.42
16	Panel Shutter of door & Window (each Panal Consisting Of single Plan without Join) 25 mm thick shutter with 12 mm thick Panal of size 30 to 45 cm. Other Local wood <b>SOR, PWD, P-105, I -84 (iv)c</b>	8.520	sq.m.	1567.00	13350.84
17	Iron butt hinges of approved quality fitted and fixed with steel screws, with ISI mark. a)75mm x 47mm x 1.70mm <b>SOR, PWD, P-91, T -20(iv)</b>	32.000	each	34.00	1088.00
18	Iron Socket Bolt of approved quality fitted and fixed complete. i) 150 mm long x 10 mm dia <b>SOR, PWD P-93, I-25,c</b>	11.000	each	71.00	781.00
19	White washing including cleaning and smoothening surface thoroughly (5 parts of stone lime and 1 part of shell lime should be used in the finishing coat). Two Coats <b>SOR, PWD, P-155, I -3 (b)</b>	124.960	%sq.m	1887.00	2358.00
20	Colour washing with ella with a coat of white wash priming including cleaning and smoothening surface thoroughly external surface One Coat <b>SOR, PWD, P-155, I - 4(ii)(a)</b>	100.560	%sq.m	1514.00	1522.48
21	Priming one coat on timber, plastered or on steel or other metal surface with synthetic enamel/oil bound primer of approved quality including smoothening surfaces by sand papering etc. 1) On timber surface <b>SOR, PWD, P - 162, I - 7(a)</b> 2) On Steel Surface <b>SOR, PWD, P - 162, I - 7(b)</b>	21.690	sq.m.	41.00	889.29
		2.700	sq.m.	31.00	83.70
22	Painting with best quality synthetic enamel paint of approved make and brand including smoothening surface by sand papering etc. including using of approved putty etc. on the surface, if necessary : With simer gloss (hi-gloss)-With any shade except white a) On timber or plastered surface Two Coats b) On Steel surface Two Coats <b>SOR, PWD, P - 162, - 8A(aii),(bii)</b>	21.690	sq.m.	89.00	1930.41
		2.700	sq.m.	86.00	232.20

No.	Description of Works	Quantity	Unit	Rate (Rs.)	Amount (Rs.)
23	Iron hasp bolt of approved quality fitted and fixed complete (oxidised) with 16 mm dia with center bolt and round fitting. 300 mm long <b>SOR, PWD, P-93, I - 27c</b>	2.000	each	193.00	386.00
24	Precast pored concrete jally work as per design and manufacture's specification including moulding etc. with stone chips and necessary reinforcement shuttering complete including fitting, fixing in position in all floors. (a) 37.5 mm th. panels Cement & steel required for this item <b>will not be</b> issued by deptt. <b>SOR, PWD, P-32, I - 38 (b)</b>	1.690	sq.m.	351.00	593.19
25	Supplying, fitting and fixing UPVC down pipes A type and fittings conforming to IS 13592-1992 with necessary clamps nails including making holes in walls, etc. and cutting trenches in any soil, through masonry concrete structure etc. if necessary and mending good damages including jointing with jointing materials ( Spun yarn, valamoid / bitumen / M. seal etc.) complete. <b>P-173, I-21 A (ii), C(ii), D(ii)</b> <b>SOR, PWD, P173, I - 21 A (ii), C(ii), D(ii)</b> i) UPVC Pipe 110 mm dia ii) UPVC Bend 87.5 degree 110 mm dia iii) UPVC Shoe 110 mm	3.000 2.000 1.000	Mtr. each each	291.00 162.00 128.00	873.00 324.00 128.00
26	M.S.or W.I. Ornamental grill of approved design joints continuously welded with M.S, W.I. Flats and bars of windows, railing etc. fitted and fixed with necessary screws and lugs in ground floor. Grill weighing 10 kg/sq m to 16 kg/m <sup>2</sup> <b>SOR, PWD, P - 76, I - 10 (I)</b> <b>(2.70sqm @ 10.5kg per sqm = 28.35 kg)</b>	0.284	Qntl	8247.00	2342.15
27	Shallow water closet Indian pattern(I.P.W.C.) of approved make in white vitreous chinaware supplied ,fitted and fixed in position (excluding cost of concrete for fixing). 450 mm long <b>SOR, PWD, (Sanitary) P - 65, I - 1 (iii)</b>	1.000	each	1062.00	1062.00
28	Foot rest for water closet of size 275 mm X 125 mm with Artificial stone(4:2:1) with 6 mm stone chips and chequered including adding colour as necessary. <b>SOR, PWD, (Sanitary) P - 66, I - 9</b>	1.000	Pair	70.00	70.00
29	Supplying,fitting and fixing cast iron 'P' or 'S' trap conforming to I.S. 3989 / 1970 and 1729 / 1964 including lead caulked joints and painting two coats to the exposed surface. S Trap 100 mm <b>SOR, PWD, (Sanitary) P - 54, I - 14(B-iii)</b>	1.000	each	923.00	923.00
30	Supplying, fitting fixing CI Round Gratings 150mm dia <b>SOR, PWD, (Sanitary) P - 55, I - 18(ii)</b>	1.000	Each	100.00	100.00
	Construction of 2 circular leach pit of inside diameter 1000 mm. & a depth of 1000 mm. With a layer of 250 mm. Thick brick work with cement mortar (6:1) & honeycombed brick wall (4:1) at every alternate layer upto a height of 925 mm. From bottom and then 125 mm. thick brick wall (4:1) for a height of 300 mm. and covered with 75m. RCC slab (4:2:1) with 8mm tor steel @ 150 mm. centre to centre both ways including plastering and neat cement punning on top of the slab and making hooking arrangement on slab for lifting of the slab if require as well as jointing the connection with the inspection pit (450 x 450) covered with 50mm thick RCC slab (4:2:1) with stone chips and necessary reinforcement and connected with 100 mm dia PVC pipe laid over rammed earth and then covered the pipe properly with powder earth including supplying fitting fixing fibre glass pan P tap & polythene pipe as per requirement to connect with the inspection pit complete with all respect as per direction of EIC.(ANNEXURE-II)	1	Item	7544.00	7544.00
<b>TOTAL AMOUNT</b>			<b>Rs.</b>		<b>350000.36</b>
<b>Say</b>			<b>Rs.</b>		<b>350000.00</b>
<b>Add for Electrical Works (ANNEXURE-I)</b>			<b>Rs.</b>		<b>17858.00</b>
<b>TOTAL AMOUNT</b>			<b>Rs.</b>		<b>367858.00</b>

(Rupees Three lakh Sixty seven thousand Eight hundred & Fifty eight only)

**Cost Estimate for 2 Nos Leach Pit for single unit Dwelling Unit  
P.W.D Schedule of Rates effect from 1st July 2014**

**(ANNEXURE-II)**

Sl No	Description of Items	Quantity	Unit	Rate	Amount
1	Earth work in excavation of foundation trenches or drains in all sorts of soil (including mixed soil but excluding or stacking the spoils within a lead of 75 m. as directed. The item includes necessary trimming the sides of trenches leveling dressing and ramming the bottom boiling out water aqs required complete. Depth of exavation not existing 1500mm <b>P.No-1, I-2(a)</b>	2.500	%Cu.M	12047.00	301.18
2	Cement concrete with graded jhama kha ballast (30 mm size) excluding shuttering. In ground floor and foundation (a) 6:3:1 proportion.	0.050	Cu.M	5803.06	290.15
3	Brick work with 1st class bricks in cement mortar (6 :1). a) In foundation & Plinth <b>P.no-29, I-21(a)</b>	0.010	Cu.M	5719.00	57.19
4	125 mm. thick brick work with 1st class bricks in cement mortar (4 : 1) G.Floor <b>P.no-31, I-29</b>	3.000	SqM	714.00	2,142.00
5	Controlled Cement concrete with well graded stone chips (20 - mm nominal size) excluding shuttering and reinforcement with complete design of concrete as per I : 456 and relevant special publications submission of job mix formula after preliminary mlx design after testing of concrete cubes as per direction of Engineer-in charge Consumption of cement will not be less than 300 Kg of cement -with Super plasticiser per cubic meter of controlled concrete but actual consumption will be determined on- the basis of preliminary test and job mix formula. -In ground floor and foundation. [Using concrete mixture] M 20 Grade	0.145	Cu.M	6871.54	996.37
6	Reinforcemnet for reinforced concrete work in all sorts of structures incl. Distribution bars, stirrups, binder etc. incl. supply of rods, initial straightening & removal of loose rust (if necessary), cutting to requisite length, hooking etc <b>P.no-27, I-15(a)(i)</b>	0.010	M.T	68508.00	685.08
7	Supplying, fitting and fixing UPVC down pipes A type and fittings conforming to IS 13592-1992 with necessary clamps nails including making holes in walls, etc. and cutting trenches in any soil, through masonry concrete structure etc. if necessary and mending good damages including jointing with jointing materials ( Spun yarn, valamoid / bitumen / M. seal etc.) complete.				
	i) UPVC Pipe 110 mm dia <b>P.no-173 I</b>	4.000	Mtr	291.00	1,164.00
	ii) UPVC Bend 87.5 degree 110 mm dia <b>P.no-174, I-21(B)C(ii)</b>	2.000	Each	162.00	324.00
8	Jaffri brick work 125 mm. thick with 1st class bricks in cement mortar (4:1) including 12 mm. thick cement plaster (4:1) in all faces in ground floor <b>P.no-32, I-35</b>	2.000	SqM	792.00	1,584.00
<b>Cost of 2 no leach pit</b>					<b>7,543.97</b>

**ESTIMATE FOR ELECTRICAL WORKS FOR ONE DWELLING UNIT UNDER RAY  
(ANNEXURE-I)**

Sl.No	SOR	Item of works	Unit	Rate	Quantity	Amount
1	PWD/Vol-I (Aug 2008) A/1(b)/E-9	Supplying & fitting polythene pipe complete with fittings as necessary. Under ceiling/beam/bound with 22SWG GI wire inclusive S & Drawing 1x18 SWG GI wire as fish wire inside the pipe & fittings and providing 55 mm dia disc of MS sheet (20SWG) having colour paint at one face first ended at the load point end of the polythene pipe with fish wire (synchronizing with roof/beam casting work of building construction) 19 mm dia 3 mm thick polythene pipe	RM	39.00	25.00	975.00
2	PWD/Vol-I (Aug 2008) A/1(m)/E-17	Powerckt wiring supplying and drawing 1 ; 1KV grade single core stranded FR PVC insulated & unseathed single core stranded Copper wire (Finolex make) 2 x 2.5 sqmm (PH & N) + 1x1.5 sqmm (ECC) per laid polythene pipe and by the pre-laid GI fish wire & making necessary connections as required.	RM	76.00	50.00	3800.00
3	PWD/Vol-I (Aug 2008) A/1/2 (a-i)/E-17	Concealed Distribution wiring in in 2x1.5 sqmm single core standard *FR* insulated and unseathed cop per wire Finolex make & 1x1.5 sq mm single core stranded PVC insulated and unseathed cop per (Finolex make) wire used as ECC in 19 mm bore 3 mm thk. polythene pipe complete with all accessories embedded in wall smooth run to light / fan/call bell point with piano key type switch (6 Amps) (Anchor make) fixed on sheet metal (16 SWG) Switch Board with bakelite/ perspex (wall matching colour) Top cover (3 mm thick) flushed in wall including mending all good damages to original finish Average per point 6.00 mt.	points	828.00	10.00	8280.00
4	PWD/Vol-I (Aug 2008) A/4 (a-i)/E-18	Deistribution concealed wiring with 2x1.5 sq mm (PH & N) single core stranded FR PVC insulated & unseathed single core stranded 1.1 KV grade Copper Wire (finolex) & 1x1.5 sq mm (ECC) single core stranded (PH & N) 1.1 KV grade cu wire (finolex) & 1 x 1.5 sq mm single core stranded PVC insulated & unseathed cu wire (finolex) used as ECC in 19 mm bore, 3 mm thick polythene pipe complete with all accessories embedded in wall 250 volt 5 amp 3 pin plug point including S & F 250 Volt 5 amp 3 pin flush type plug socket & piano key type switch (Anchor make) on existing switch board as mentioned sl. no.3	points	76.00	2.00	152.00



Sl.No	SOR	Item of works	Unit	Rate	Quantity	Amount
5	PWD/Vol-1 (Aug 2008) E-17, A 1-e	Supplying & drawing 1.1 KV grade single core stranded FR PVC insulated & unseathed single core stranded cu Wire 3x2.5 sq mm (finolex make) in the pre-laid polythene pipe & by the pre-laid GI fishwire & making necessary connection as required (CESC supply to consumer DP near to CESC & inside the room another DP near CESC & inside the room another DP of dwelling units)	RM	86.00	15.00	1290.00
6	KMC 2008-09)A/(1/e) p/(h)	Supplying Delivery & instalation on wall of 30/32 amp DP MCB of Havel's make with enclosed box along with all its necessary   connection complete (Anchor)	nos	808.00	2	1616.00
7	PWD/Vol-1 (Aug 2008) 2(a) G-1	Earthing in soft soil with 50 mm dia GI pipe (TATA make Medium ) 3.64 mm th. X 3.04 Mtr long and 1 x 4 SWG GI ( hot dip) wire (4 m long) 13 mm dia x 80 mm long GI bolts, double nuts, double washer including S & F 15 mm dia GI protection (1 mtr long) to be filled with bitumen partly under the ground level & partly above GI driven to an average depth of 3.65 m below the GI & restoring surface duly rammed.	each	1715.00	1	1715.00
8	PWD/Vol-1 (Aug 2008) 5(a-iv) G-3	Connecting the equipment to earth BUSbar inclusive S&F 10 SWG (Hot Dip) GI wire on wall /floor with a staples buried inside wall /floor as required & making connection to equipments with bolt, nut, washer, cable lugs etc. as required & mending good damages.	M	6.00	5	30.00
				TOTAL		17858.00
<b>Rupees Thirteen Thousand Eight Hundred Seventy Eight Only</b>						<b>17858.00</b>

Estimate for Single Dwelling unit  
 area 25.36 sqm Built up area 32.18 sqm

	C/L of main outer wall			125 mm Partition wall		Varandah C/L
	4.65			3.375		1.275
	0.8			1.15		0.9
	1.15			1.15	2.3	2.175
	3.45			2.187		
	1.15			1.9		
	1.7			1.387	5.474	
	3.375			11.149		
	1.275					
	2.825					
	3.125					
	23.5					
	X wall	1.25				
Sl.no.						
1	Earth work in excavation					
	250 mm wall					
	1	23.5	0.75	0.7	12.34	
		0.875	0.75	0.7	0.46	
		24.375			12.8	m <sup>3</sup>
	125 mm Wall					
		2.625	0.4	0.225	0.24	
	WC	0.4	0.4	0.225	0.04	
	Bath	0.65	0.4	0.225	0.06	
	5.474	0.75		0.225		
		4.724	0.4	0.225	0.43	
	Varanda	1.425	0.4	0.225	0.13	
					0.88	
	Step	0.5	0.9	0.075	0.034	
					13.715	m <sup>3</sup>
2	Soling					
		24.375	0.75		18.281	
		11.45	0.4		4.58	
					22.861	
3	Polythene sheet					
		2.575	3.125		8.047	
		2.875	2.625		7.547	
		2	1.65		3.3	
	passage	0.625	2.375		1.484	
	Bath&WC	2.7	0.9		2.43	
	Varndah	1.025	0.6		0.615	
	step	0.9	0.5		0.45	
					23.873	
4	Jhama concrete					
			18.28	0.075	1.371	
			4.58	0.075	0.344	
			23.93	0.075	1.795	
					3.51	
5	Earth work in filling 1/5 excavation					
			13.715	5	2.743	
			23.48	0.375	8.805	
					11.548	m <sup>3</sup>

6	B.W (6:1) in Foundation of plinth								
		23.5	0.625	14.6875					
		23.5	0.5	11.75					
		23.5	0.375	8.8125					
				35.25	0.15	5.288			
		23.5	0.25		0.525	3.084			
	X wall	0.938	0.625	0.586					
		1	0.5	0.5					
		1.063	0.375	0.399					
				1.485	0.15	0.223			
		1.125	0.25		0.525	0.148			
	125mm	3.125	0.25		0.525	0.41			
	Bath&WC		2 0.9	0.25	0.523	0.235			
	Kit	5.224	0.25		0.525	0.686			
	Vard	1.925	0.25		0.525	0.253			
	Steps		0.5 0.9		0.15	0.068			
			0.25 0.9		0.15	0.031			
						10.427	m		
7	DPC	23.5							
		1.125							
		24.625		0.25		6.156			
		3.125							
		1.8							
		5.224							
		10.149		0.125		1.269			
						7.425			
	Less		0.9	0.25	0.225				
			0.9	0.125	0.113				
		3	0.75	0.125	0.281				
						0.619			
						6.806	sqm		
8	BW in super structure (6:1)								
		23.5							
		1.125							
		24.625	2.75	0.25	16.93				
	Parapet	23.8	0.075	0.25	0.446				
						17.376			
	Less opens								
		1 0.9	2.1	1.89					
		4 0.9	0.9	3.24					
		1 0.75	0.9	0.675					
		3 0.75	0.75	1.688					
				7.493	0.25	1.873			
	Lintel								
		1 1.525	1.525						
		4 1.2	4.8						
		1 1.05	1.05						
			7.375	0.25	0.1	0.184			
	Wo2								
		1 3.05	3.05	0.25	0.1	0.076			

					(-)	2.134		
	Net brick work						15.212	m <sup>3</sup>
9	125 th. Brick work (6:1)							
	room		3.125	2.6		3.125		
	kit		2.125	2.75		5.844		
			1.65	2.75		4.5375		
			1.45	2.65		3.8425		
	2		0.9	2.1		3.78		
							26.12875	
	Less opening							
	1	0.9	0.9					
	3	0.75	2.25					
			3.15	2.1		6.615		
	Lintel							
	1	1.3	1.3					
	1	1.025	1.025					
			2.325	0.1		0.2325		
							6.8475	
							19.28125	
	Parapet							
		23.5		0.15		3.525		
							22.806	
	passeege		0.75	0.55		0.4125		
							23.219	sqm
10	Conc M-20							
	Roof slab							
	32.15	1.1475	31.003		0.1	3.1		
	Beam		3.625	0.25	0.15	0.136		
			2.575	0.25	0.1	0.064		
	Lintel						3.301	
	D1	1	1.325	1.325				
	W1	4	1.2	4.8				
	W2	1	1.05	1.05				
	WO2	1	3.05	3.05				
				10.425	0.25	0.1	0.261	
	D1	1	1.39	1.39				
	D2	1	1.025	1.025				
	D2	2	1.4	2.8				
	O2	1	0.875	0.875				
	D2	2		6.09	0.125	0.1	0.076	
	Chaja							
	W1	4	1.2	4.8				
	W2	1	1.03	1.03				
	D1	1	1.275	1.275				
	WO2	1	3.05	3.05				
				10.155	0.3	0.075	0.228	
							3.866	m <sup>3</sup>
11	Reinforcement							
		3.866	0.80%	1	7850	0.243	MT	

12	Shuttering						
	31	23.5	1.125				
			24.63	0.25			
	31			0.156	24.844		
	Side beam		2 3.125	0.15	0.9375		
			2 2.325	0.1	0.465		
	side slab		1 25.3	0.1	2.53		
	Lintel		1	0.9 0.25	0.225		
			1 1.525	0.1	0.153		
			1 1.275	0.35	0.446		
			1 0.3	0.05	0.015		
						29.615	sqm
	4W1		4 0.9	0.25	0.9		
			4 1.2		0.1 0.48		
			4 1.2	0.35	1.68		
	2		4 0.3	0.05	0.12		
	1W2		1 0.75	0.25	0.188		
			1 1.05		0.1 0.105		
			1 1.05	0.35	0.368		
	2		1 0.3	0.05	0.03		
	WC2		3 0.75	0.25	0.563		
	1		1 3.05		0.1 0.305		
			1 3.05	0.35	1.068		
	2		1 0.3	0.05	0.03		
	Lintel 125 Wall						
	D1		1 0.9	0.125	0.113		
			2 1.3	0.1	0.26		
	D2		2 0.75	0.125	0.188		
	2		2 1.15	0.1	0.46		
	D2		2 0.75	0.125	0.188		
			2 1.9	0.1	0.38		
						7.423	
						37.038	sqm
13	Plaster (6:1)						
	Out side 15 mm th.						
			2.85	1.125	0.45		
	25.3				4.425	111.953	sqm
	Inside 20 mm th.						
	2 2.7		3.125	2.75	32.038		
	2 2.875		2.625	2.75	30.25		
	2 2		1.65	2.75	20.075		
	2 2.075			2.75	11.413		
	Above lintel						
	1		0.75	0.65	0.488		
	Bath						
	2		0.9	2.75	4.95		
	WC						
	1		2.95	2.75	8.113		
	1		2.25	2.75	6.188		
	4		2.2	0.9	7.92		
	T. 125 wall						

	2	0.9		0.125	0.225				
								121.658	
	Open out side less								
	3	0.75		2.1	4.725				
					(-)	4.725			
								116.933	Sqm
	Celling Plaster					24.47			
	Less					1.14			
								23.33	Sqm
14	Neat cement punning								
	Out side	Plinth							
		25.3	0.45					11.385	Sqm
									11.385
	Inside		2.7		3.125				
			2		5.825	0.1		1.165	Sqm
					2.875				
					2.625				
			2		5.5	0.1		1.1	Sqm
	Kithen		2		1.65				
			2		3.65	0.45		3.285	Sqm
			1		1.65	0.45		0.743	Sqm
			2		2.075	0.1		0.415	Sqm
	Varanda				1.775	0.1		0.178	Sqm
	step WC		1		3	0.45		1.35	Sqm
	Bath				3.3	2		7	Sqm
					0.75	0.1		0.075	Sqm
	In side punning							15.31	15.31
	Total								26.695
									Sqm
15	Art. Stone flooring								
	Floor area							25.37	Sqm
	Step		2	0.9	0.25			0.45	
	W1		4	0.9	0.1			0.36	
	W2		1	0.75	0.1			0.075	
	W3		3	0.75	0.1			0.225	
									26.48
									Sqm
16	Ms Clamp for door & window								
	D1+D2		4					24	
	W1+W2		5		2			10	
									34 nos.
17	Wood work in Door & window frame								
	D1		2	5.1	10.2				
	D2		2	4.95	9.9				
	W1		4	3.6	14.4				
	W2		1	3.3	3.3				
					37.8	0.075	0.075	0.213	m
18	Z batten shutter								
	D1		2	0.775	2.025			3.139	
	D2		2	0.625	2.025			2.531	
	W1		4	0.775	0.775			2.403	
	W2		1	0.775	0.625			0.484	
									8.557
									Sqm
19	Iron Butt Hinges								

	D1-D2					12		
	W1	1	4			16		
	W2	1	4			4		
							32 nos.	
20	Iron socket bolt							
	Door				6			
	Window				5			
							11 nos.	
21	White wash							
	Inside+Ceiling Plaster- inside punning							
		116.933	23.38	15.31		124.953	sqm	
22	Colour wash							
	Out side Plaster- out side punning							
		111.953	11.85			100.568	sqm	
23	Priming on timber surface							
	2	2 0.9	2.1		7.56			
	2	2 0.75	2.1		6.3			
	4	2 0.9	0.9		6.48			
	1	2 0.75	0.9		1.35			
						21.69	sqm	
24	Painting best quality on wooden surface							
	same sl.no. 23					21.69	sqm	
25	MS ornamental grill....10Kg-16 Kg							
	W1	4 0.75	0.75	2.25				
	W2	1 0.75		0.6 0.45				
				2.7				
				@12Kg/sqm		32.4	Kg	
26	Priming on Steel surface					2.7	sqm	
27	Painting best quality on steel surface					2.7	sqm	
	same sl.no. 24							
28	R.C.C. Shelf							
		1.75 0.5				0.875	sqm	
29	Roof treatment with cow dang							
				32.18				
	Deduct	1.14 (varanda)	1.14					
	Cornice	25 0.125	3.125					
			27.915			27.915	sqm	

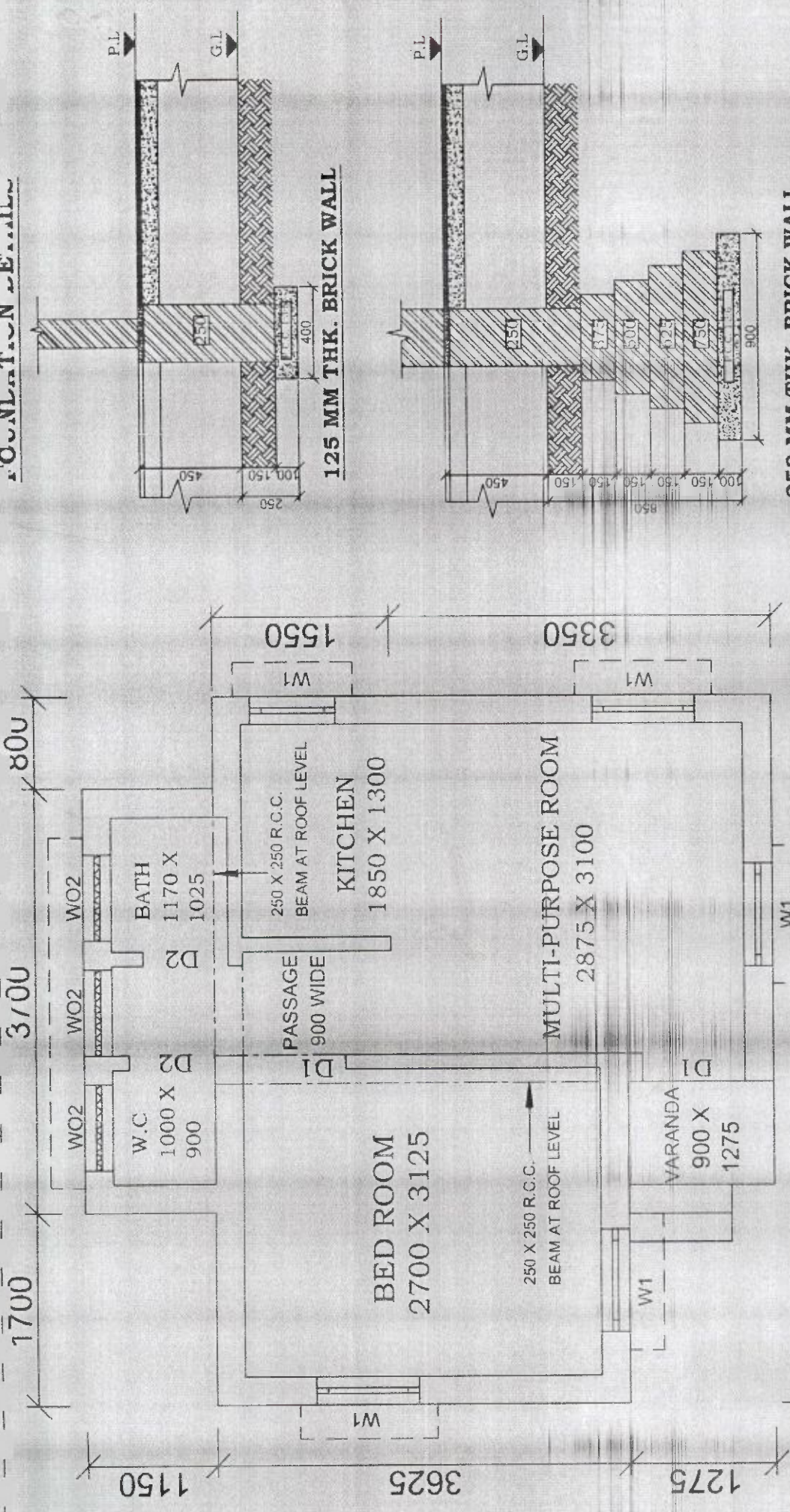

NOTE:-

1. ALL WINDOW OPENINGS (W1 & W2) WILL BE PROVIDED WITH Z-BATTEN SHUTTERS.
2. ALL DOORS (D1 & D2) - 25TH Z-BATTEN SHUTTERS, SINGLE LEAF.
3. W02 - OPENING PROVIDED WITH R.C.C. JALLI.
4. PLINTH HEIGHT - 450 TH.
5. CEILING HEIGHT - 2750 TH.
6. MAIN WALL - 250 TH.
7. PARTITION WALL - 125 TH.
8. ROOF SLAB, BEAM, LINTEL, ETC. WITH REINFORCED CEMENT CONCRETE M20 GRADE.
9. FLOOR OF VERANDAH, WC, BATH, & KITCHEN ROOM TO BE KEPT 15 MM BELOW THE FLOOR LEVEL OF ROOM & PASSAGE.
10. 100 MM TH. PIECE LINTEL OVER OPENING HAVE BEEN PROVIDED.
11. ALL DIMENSION ARE IN MM.

DOORS & WINDOWS SCHEDULE	
MARKING	DIMENSION
W1	900 X 900
W2	750 X 900
W02	750 X 750
D1	900 X 2100
D2	750 X 2100

FLOOR AREA - 25.37 SQM.  
 BUILT UP AREA - 32.18 SQM.

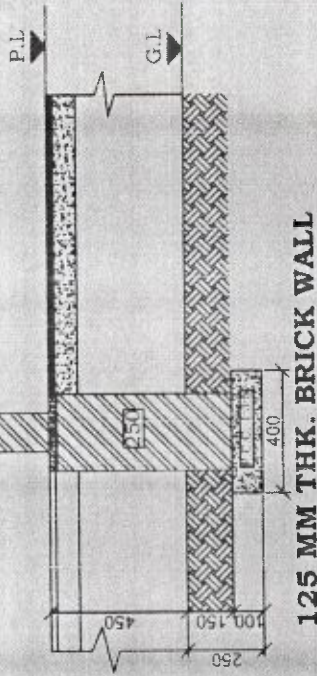

125 MM THK. BRICK WALL

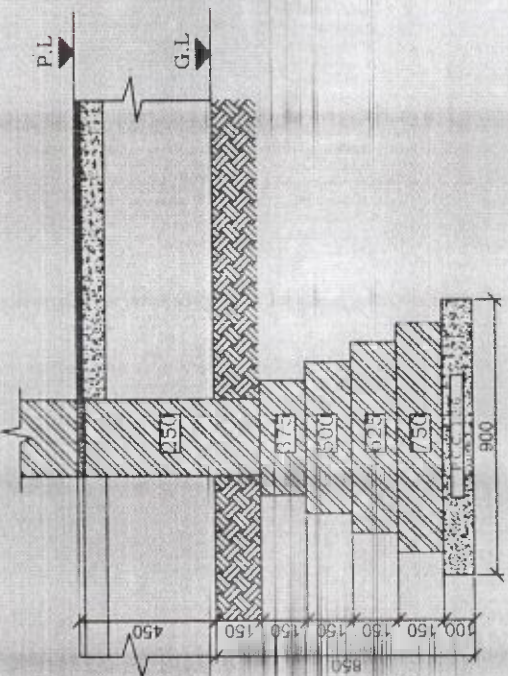

250 MM THK. BRICK WALL

**PRADHAN MANTRI AWAS YOJANA**  
 HOUSING FOR ALL (URBAN)

OFFICE OF THE CHIEF ENGINEER  
 MUNICIPAL ENGINEERING DIRECTORATE  
 GOVT. OF WEST BENGAL

DWG. NO. \_\_\_\_\_ SCALE :- 1:50 & 1:25



# RATE ANALYSIS OF ORDINARY C. C WORK (1:2:4) AT TAKI MUNICIPALITY

RATE OF ORDINARY C. C WORK (1:2:4) AT TAKI MUNICIPALITY = A + B + C + D

A = Relevant rate at P.W.D., Schedule of rates 2014 = Rs. 4,603.00

B = Cost of Stone materials

C = Carriage at site

D = Cost of loading & unloading

## (B) Cost of stone materials at nearest Railway Yard

- (1) 20 mm graded stone chips at Barasat Railway Yard = Rs. 1,520.00  
 (2) 10 mm graded stone chips at Barasat Railway Yard = Rs. 1,353.00

## (C) Carriage at site ( Taki Municipality)

Distance from Barasat to Taki by road = 58 km.

Carriage upto 5 Km.	5 Km. to 10 Km. Rs. 10.90 Per Km.	10 Km. to 20 Km. Rs. 10.10 Per Km.	20 Km. to 50 Km. Rs. 9.50 Per Km.	50 Km. to 100 Km. Rs. 8.40 Per Km.
Rs. 124.00	Rs. 10.90 = 5 x Rs. 10.90 = Rs. 54.50	Rs. 10.10 = 10 x Rs. 10.10 = Rs. 101.00	Rs. 9.50 = 30 x Rs. 9.50 = Rs. 285.00	Rs. 8.40 = 8 x Rs. 8.40 = Rs. 67.20

## (D) Cost of Loading & Unloading = Rs. 58.00 per cum.

COST OF 20 MM STONE CHIPS AT SITE = (B-C+D)  
 = Rs. 1,520.00 + (Rs. 124.00 + Rs. 54.50 + Rs. 101.00 + Rs. 285.00 + Rs. 67.20) + Rs. 58.00 = Rs. 2,209.70

COST OF 10 MM STONE CHIPS AT SITE = (B+C+D)  
 = Rs. 1,353.00 + (Rs. 124.00 + Rs. 54.50 + Rs. 101.00 + Rs. 285.00 + Rs. 67.20) + Rs. 58.00 = Rs. 2,042.70

COST OF 20 MM STONE CHIPS for 1 cum. C.C. WORK (1:2:4) AT SITE = 0.66 cum x Rs. 2,209.70 = Rs. 1,458.40  
 COST OF 10 MM STONE CHIPS for 1 cum. C.C. WORK (1:2:4) AT SITE = 0.22 cum x Rs. 2,042.70 = Rs. 449.39

Total = Rs. 1,907.79

So, Rate as per Annex -II = (A) + (B+C+D) = (A) + Rs. 1,907.79 = Rs. 4,603.00 + Rs. 1,907.79 = Rs. 6,510.79

Rate as per Annex - II = Rs. 6,510.79 say (A)  
 Deduct Cost of Cement :- 0.22 x Rs. 8,100 / 0.70 = Rs. 2,545.71 say (B)  
 Add Cost of Cement :- 0.22 x Rs. 7,364.00 / 0.70 x 1.1 = Rs. 2,545.84 say (C)

So, Compact Rate of C. C. Work (1 : 2 : 4) at TAKI MUNICIPALITY = A - B + C

= Rs. 6,510.79 - Rs. 2,545.71 + Rs. 2,545.84 = Rs. 6,510.92

  
 Sub-Asstt. Engineer  
 TAKI MUNICIPALITY

**OFFICE OF THE MUNICIPAL COUNCILLORS OF TAKI**  
**POST-TAKI, DIST-NORTH 24 PARGANAS, PIN-743429**

CONSTRUCTION OF C. C. ROAD PER SQ. M.(TYPE -A) AT DIFFERENT WARD WITH IN TAKI MUNICIPALITY UNDER HFA

(ID)

Estimate prepared as per PWD schedule of rates Building W.E.From 1-7-14 Including Cess @ 1%

Length =1.00m, Width=2.1m So Area=1.00x2.10=2.05Sq.m.

Sl. No	Description of Items	Quantity	Unit	Rate	Amount
1	<b>P-1/I-2a</b> <b>Earth work in excavation</b> of foundation trenches or drains in all sorts of soil(including mixed soil but excluding laterite or sandstone) including removing. Spreading or stacking the spils within a lead of 75m. As directed. The item includes necessary trimming the sides of trenches, leveling dressing and ramming the bottom, bailing out water as required complete. (a) Depth of excavation not exceeding 1500 mm. 1.00 X2X 0.25 X 0.225 = 0.112	0.11	cu.m.	120.47	13.49
2	<b>P-11/I-1</b> Single Brick Flat Soling of picked jhama bricks including ramming and dressing bed to proper level and filling joints with local sand. 1.00X2X0.250=0.5	0.50	sq.m.	377.00	188.50
	<b>P-11/I-4(a)</b> <b>Cement concrete with</b> graded jhama khoa(30 mm size) excluding shuttering. In ground floor and foundation. (a) (6:3:1) proportion 1.00x2X0.250x0.075=0.037	0.37	cu.m.	5803.00	2147.11
	<b>P-31/I-29</b> 125 mm. thick brick work with 1st class bricks in cement mortar (1:4) in ground floor. 1X1.00X2X0.225=0.45	0.45	sq.m.	783.00	352.35
	<b>P-2/I-4</b> <b>Filling in foundation or plinth by silver sand</b> in layers not exceeding 150 mm as directed and consolidating the same by thorough saturation with water ramming complete including the cost of supply of sand. (payment to be made on measurement of finished quantity). 1.00x1.85x0.15=0.277	0.28	cu.m.	985.24	272.91
	<b>P-45/I-13</b> Supplying and laying polythene sheet (150gm/sq.m.) over damp proof course or below flooring or roof terracing or in foundation or in foundation trenches. 1.00x2.4= 2.40	2.40	sq.m.	25.00	60.00
	<b>P-27/I-14</b> <b>Hire and labour charges for shuttering with hard wood for precast R.C. slab curved</b> or strngth and striking out the same including fitting, fixing the precast slab in position with necessary carriage and haulage hosting etc complete in all respect. 2x1.00x0.15=0.3	0.30	sq.m.	100.00	30.00

Sl No	Description of Items	Quantity	Unit	Rate	Amount
8	P-12/l-5(a) Ordinary cement concrete m15 (mix 4:2:1) with grades stone chips (20 mm down) excluding shuttering and reinforcement, if any . As per IS 456- 2000 (a) Pakur/ Chandi Varit  1.00x2.10x0.15=0.315	0.32	cu.m.	6510.92	2050.94
<b>Total Rs.</b>					5115.30

Per 2.1sq.m RS.=2413.85 So Per sq.m.=2413.85/2 =1206.92

One Thousand Two hundred and Seven only

Say Rs. 1207.00

Type (A) Total Area=4024.20 sq.m.= Rs. 4857209.40

  
 S.A.E.  
 TAKI MUNICIPALITY

Sub-Assst Engineer  
 TAKI MUNICIPALITY

  
 CHAIRMAN  
 TAKI MUNICIPALITY

Chairman  
 TAKI MUNICIPALITY

SECTION OF CEMENT CONCRETE ROAD IN DIFFERANT  
WARD WITHIN TAKI MUNICIPALITY UNDER HFA (ID)

NOTES :-  
ALL DIMENSIONS ARE IN MM

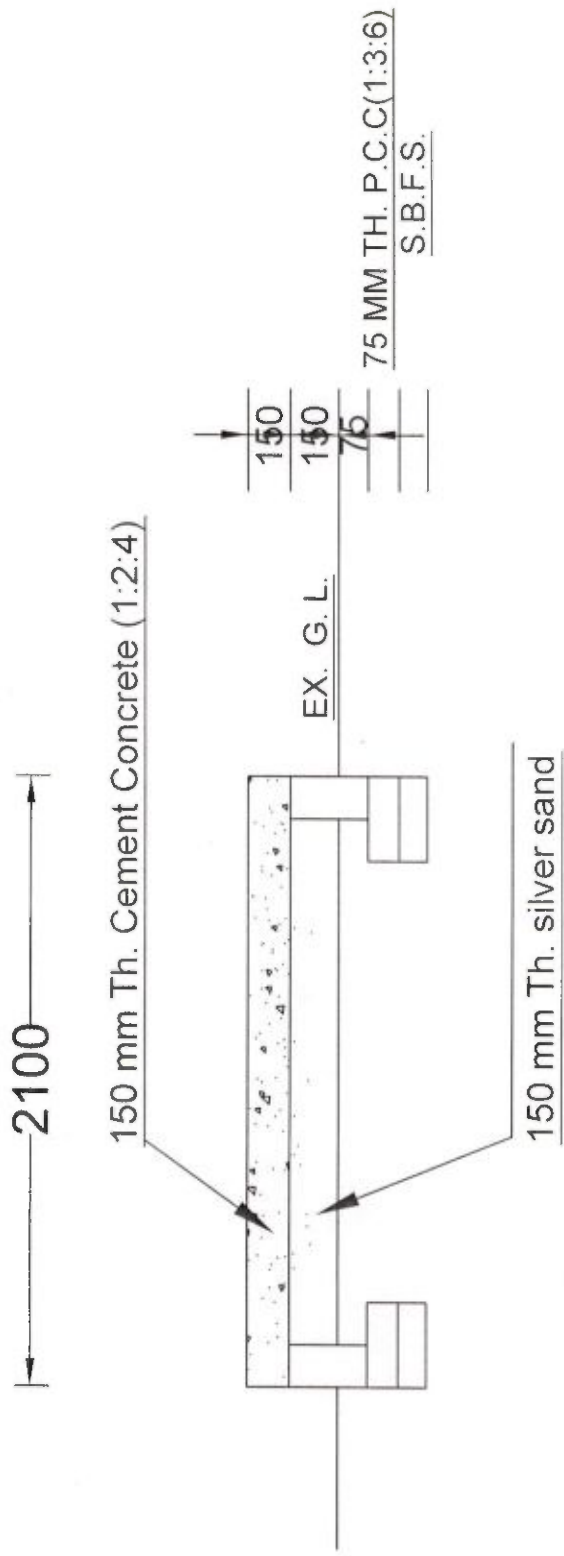

*[Signature]*

Sub-Assit. Engineer  
TAKI MUNICIPALITY

SEC. OF CEMENT CONCRETE ROAD (TYPE - A)

**POST-TAKI, DIST-NORTH 24 PARGANAS, PIN-743429**

**CONSTRUCTION OF C. C. ROAD PER SQ. M.(TYPE -B) AT DIFFERENT WARD WITH IN TAKI MUNICIPALITY UNDER HFA (ID)**

**Estimate prepared as per PWD schedule of rates Building W.E.From 1-7-14 Including Cess @ 1%**

**Lenth =1.00m, Width=2.0m So Area=1.00x2.00=2.00Sq.m.**

Sl No	Description of Items	Quantity	Unit	Rate	Amount
1	<b>P-2/I-4</b> Filling in foundation or plinth by silver sand in layers not exceeding 150 mm as directed and consolidating the same by thorough saturation with water ramming complete including the cost of supply of sand. (payment to be made on measurement of finished quantity). 1.00x2.00x0.05=0.10	0.10	cu.m.	985.24	98.52
2	<b>P-45/I-13</b> Supplying and laying polythene sheet (150gm/sq.m.) over damp proof course or below flooring or roof terracing or in foundation or in foundation trenches. 1.00x2.3=.2.30	2.30	sq.m.	25.00	57.50
3	<b>P-27/I-14</b> Hire and labour charges for shuttering with hard wood for precast R.C. slab curved or strength and striking out the same including fitting, fixing the precast slab in position with necessary carriage and haulage hosting etc complete in all respect. 2x1.00x0.15=0.3	0.30	sq.m.	100.00	30.00
4	<b>P-12/I-5(a)</b> Ordinary cement concrete m15 (mix 4:2:1) with grades stone chips (20 mm down) excluding shuttering and reinforcement, if any . As per IS 456-2000 (a) Pakur/ Chandi Varit 1.00x2.00x0.15=0.30	0.30	cu.m.	6510.92	1953.28
<b>Total Rs.</b>					<b>2139.30</b>

**Per 2.0sq.m RS.=2139.3 So Per sq.m.=2139.3/2 =1069.65**

**One Thousand and Seventy only**

**Say Rs. 1070.00**

**Total AreaType-(B)=4540 sq.m.=Rs.4857800.00**

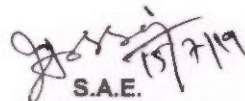
  
S.A.E.  
TAKI MUNICIPALITY  
Sub-Assst Engineer  
TAKI MUNICIPALITY

  
CHAIRMAN  
TAKI MUNICIPALITY  
Chairman  
TAKI MUNICIPALITY

SECTION OF CEMENT CONCRETE ROAD IN DIFFERANT  
WARD WITHIN TAKI MUNICIPALITY UNDER HFA (ID)

NOTES :-  
ALL DIMENSIONS ARE IN MM

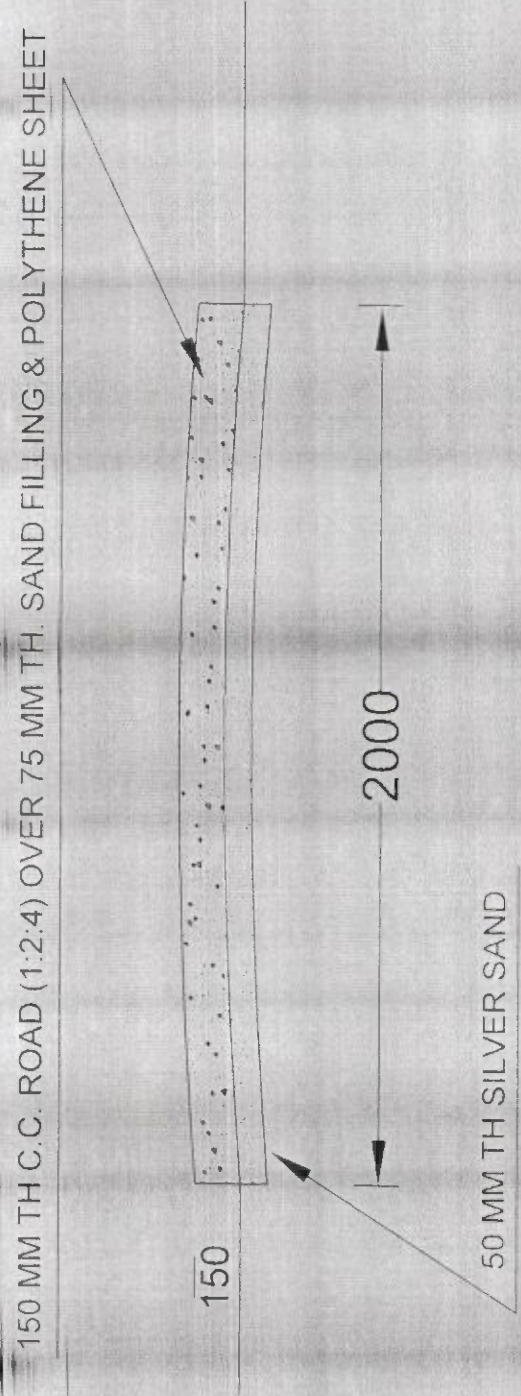

*[Signature]*  
Sub-Asstt. Engineer  
TAKI MUNICIPALITY

SEC. OF CEMENT CONCRETE ROAD (TYPE - B)

**OFFICE OF THE MUNICIPAL COUNCILLORS OF TAKI  
POST-TAKI, DIST-NORTH 24 PARGANAS, PIN-743429**

**CONSTRUCTION OF DRAIN (TYPE -A) PER M.AT DIFFERENT WARD WITHIN TAKI MUNICIPALITY FOR HFA (ID)**

Estimate prepared as per PWD schedule of rates Building w.e.f.1/7/2014 with current corrigendum including Labour Cess.1%

SI No	Description of Items	Quantity	Unit	Rate	Amount
1	<b>P-1/I-2a</b> <b>Earth work in excavation</b> of foundation trenches or drains in all sorts of soil(including mixed soil but excluding laterite or sandstone) including removing. Spreading or stacking the spils within a lead of 75m. As directed. The item includes necessary trimming the sides of trenches, leveling dressing and ramming the bottom, bailing out water as required complete. (a) Depth of excavation not exceeding 1500 mm. 1.00 X 1.375 X 1.075 = 1.478	1.48	cu.m.	120.47	178.05
2	<b>P-11/I-1</b> Single Brick Flat Soling of picked jhama bricks including ramming and dressing bed to proper level and filling joints with local sand. 1.00X1.375=1.375	1.38	sq.m.	377.00	518.38
3	<b>P-11/I-4(a)</b> <b>Cement concrete with graded jhama khoa(30 mm size)</b> excluding shuttering. In ground floor and foundation. (a) (6:3:1) proportion 1.00x1.375x0.100=0.1375	0.14	cu.m.	5803.00	797.91
4	<b>P-29/I-22(a)</b> <b>Brick work with 1st class bricks in cement mortar (6:1)</b> In foundation and plinth 1.00x0.375x0.900=0.337 1.00X0.375X0.300=0.112 1.00X0.250X0.600=0.150 Total=0.599	0.60	cu.m.	5719.00	3431.40
5	<b>P-151/I-2(i)(c)</b> Plaster (to wall, floor, ceiling etc.) with sand and cement mortar including rounding off or chamfering corners as directed and raking out joints including throating, nosing and drip course,scaffolding/staging where necessary (Ground floor).[Excluding cost of chipping over concrete surface] (ii) With 1:4 cement mortar (b) 15 mm thick plaster 1.00X2.925=2.925	2.93	sq.m.	156.00	456.30
6	<b>P-152/I-8</b> Neat cement punning about 1.5mm thick in wall,dado,window sill,floor etc.	2.93	sq.m.	38.00	111.15

7	P-1/l-3a work in filling in foundation trenches or plinth with good earth, in layers not exceeding 150 mm. including watering and ramming etc. layer by layer complete. (Payment to be made on the basis of measurement of finished quantity of work) (a) With earth obtained from excavation of foundation. 1X0.175X0.900=0.157 1x0.125x0.600=0.075 Total=0.232	Earth	0.232	cu.m	78.31	18.17
	<b>Total Rs.</b>					<b>5511.36</b>

Say Rs. 5511.00

Cost per m lenth=(Rupees Five thousand five hundred & eleven only.)

Lenth of Type -(A)=590.00 m = Rs. 3251490.00

  
S.A.E.  
TAKI MUNICIPALITY  
Sub-Asstt. Engineer  
TAKI MUNICIPALITY

  
CHAIRMAN  
TAKI MUNICIPALITY  
 Chairman  
TAKI MUNICIPALITY



SECTION OF MASONRY SURFACE DRAIN IN DIFFERANT  
WARD WITHIN TAKI MUNICIPALITY UNDER HFA (ID)

NOTES :-  
ALL DIMENSIONS ARE IN MM

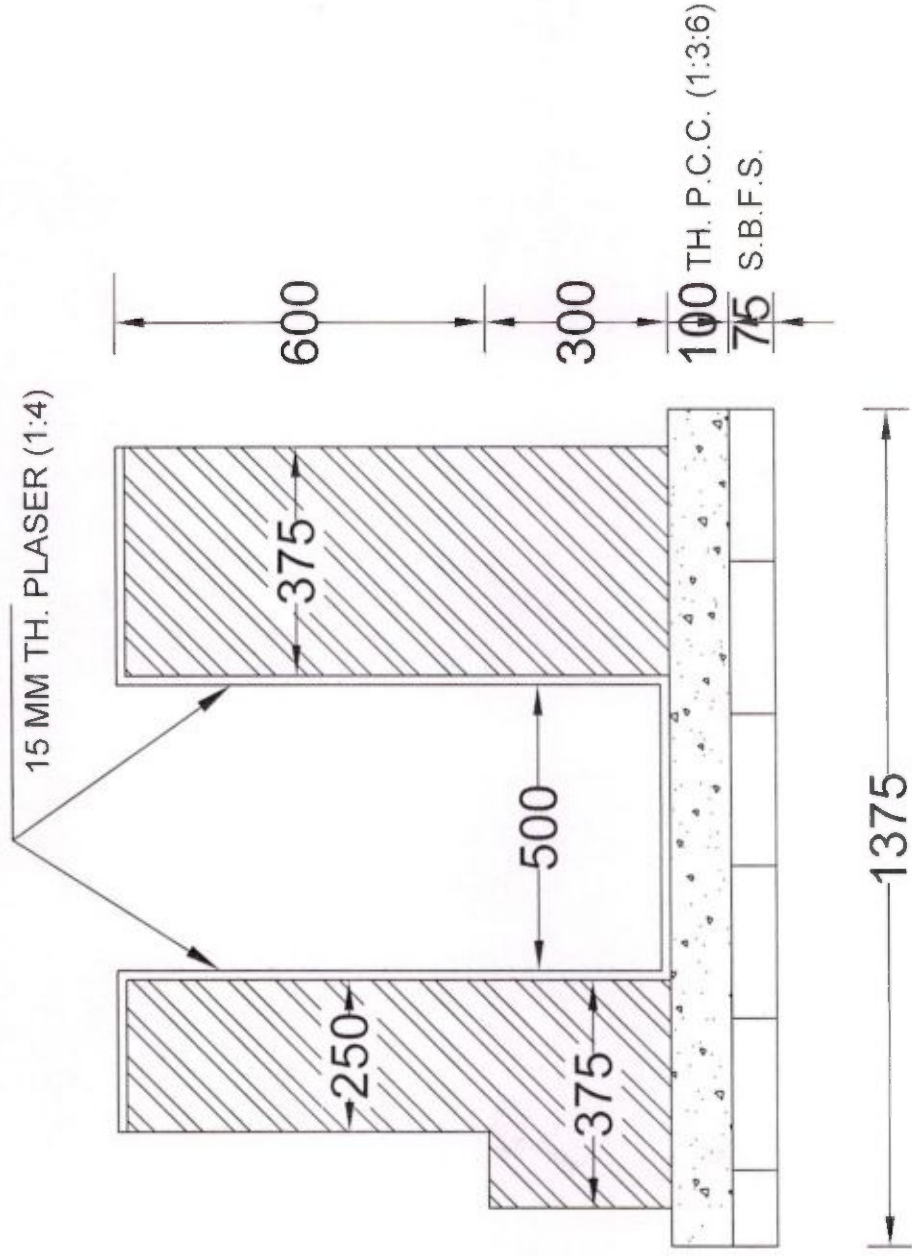

*[Signature]*  
16/7/10  
Sub-Assst. Engineer  
TAKI MUNICIPALITY

(TYPE - A) SECTION OF MASONRY DRAIN (500 MM X 900 MM)

**OFFICE OF THE MUNICIPAL COUNCILLORS OF TAKI  
POST-TAKI, DIST-NORTH 24 PARGANAS, PIN-743429**

**CONSTRUCTION OF DRAIN (TYPE -B) PER M.AT DIFFERENT WARD WITHIN TAKI MUNICIPALITY FOR HFA (ID)**

estimate prepared as per PWD schedule of rates Building w.e.f.1/7/2014 with current corrigendum including Labour Cess.1%

Description of Items	Quantity	Unit	Rate	Amount
<b>P-1/I-2a</b> <b>Earth work in excavation</b> of foundation trenches or drains in all sorts of soil (including mixed soil but excluding laterite or sandstone) including removing, spreading or stacking the spoils within a lead of 75m. As directed. The item includes necessary trimming the sides of trenches, leveling dressing and ramming the bottom, bailing out water as required complete. (a) Depth of excavation not exceeding 1500 mm. $1.00 \times 1.00 \times 0.875 = 0.875$	0.88	cu.m.	120.47	105.41
<b>P-11/I-1</b> Single Brick Flat Soling of picked jhama bricks including ramming and dressing bed to proper level and filling joints with local sand. $1.00 \times 1.00 = 1.0$	1.00	sq.m.	377.00	377.00
<b>P-11/I-4(a)</b> <b>Cement concrete with graded jhama khoa</b> (30 mm size) excluding shuttering on ground floor and foundation. (a) (6:3:1) proportion $1.00 \times 1.00 \times 0.10 = 0.10$	0.10	cu.m.	5803.00	580.30
<b>P-29/I-22(a)</b> <b>Brick work with 1st class bricks in cement mortar</b> (6:1) in foundation and plinth $1.00 \times 1.00 \times 0.250 \times 0.750 = 0.375$	0.38	cu.m.	5719.00	2144.63
<b>P-151/I-2(i)(c)</b> Plaster (to wall, floor, ceiling etc.) with sand and cement mortar including rounding off or chamfering corners as directed and making out joints including throating, nosing and drip course, scaffolding/staging where necessary (Ground floor). [Excluding cost of chipping over concrete surface] (ii) With 1:4 cement mortar (a) 15 mm thick plaster $1.00 \times 2.40 = 2.40$	2.40	sq.m.	156.00	374.40
<b>P-152/I-8</b> Neat cement punning about 1.5mm thick in wall, dado, window sill, floor etc.	2.40	sq.m.	38.00	91.20
<b>P-1/I-3a</b> <b>Earth</b> work in filling in foundation trenches or plinth with good earth, in layers not exceeding 150 mm. including watering and ramming etc. layer by layer complete. (Payment to be made on the basis of measurement of finished quantity of work) (a) With earth obtained from excavation of foundation. $0.05 \times 0.750 = 0.075$	0.075	cu.m	78.31	5.87

Total Rs. 3678.81

Say Rs. 3679.00

Cost =(Rupees Three thousand six hundred & Seventynine only.) /Per m. Lenth

Total Lenth 880 m = Rs.3237520.00

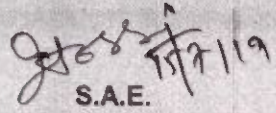

S.A.E.  
TAKI MUNICIPALITY

Sub-Asst. Engineer  
TAKI MUNICIPALITY



CHAIRMAN  
TAKI MUNICIPALITY

Chairman  
TAKI MUNICIPALITY

SECTION OF MASONRY SURFACE DRAIN IN DIFFERANT  
WARD WITHIN TAKI MUNICIPALITY UNDER HFA (ID)

NOTES :-  
ALL DIMENSIONS ARE IN MM

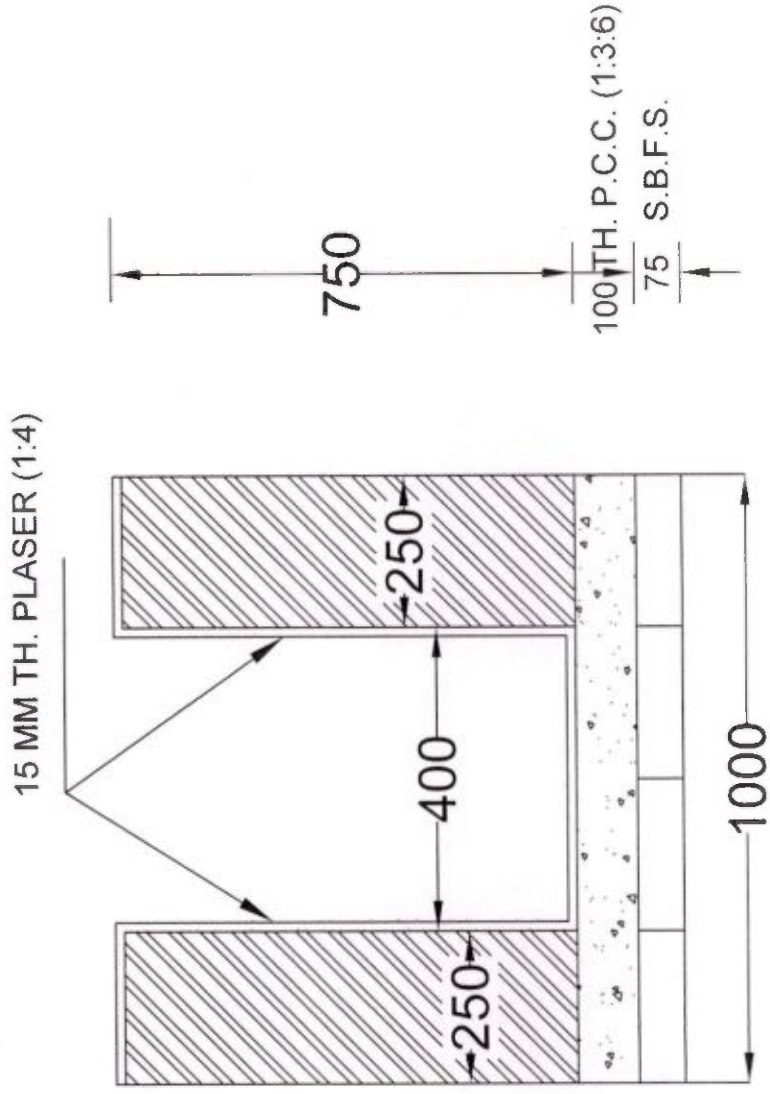

*[Signature]*  
Sub-Asstt. Engineer  
TAKI MUNICIPALITY

(TYPE - B) SECTION OF MASONRY DRAIN (400 MM X 750 MM)

**OFFICE OF THE MUNICIPAL COUNCILLORS OF TAKI  
POST-TAKI, DIST-NORTH 24 PARGANAS, PIN-743429**

**CONSTRUCTION OF DRAIN (TYPE -C) PER M.AT DIFFERENT WARD WITHIN TAKI MUNICIPALITY FOR HFA  
(ID)**

Estimate prepared as per PWD schedule of rates Building w.e.f.1/7/2014 with current corrigendum including Labour Cess.1%

SI No	Description of Items	Quantity	Unit	Rate	Amount
1	<b>P-1/I-2a</b> Earth work in excavation of foundation trenches or drains in all sorts of soil(including mixed soil but excluding laterite or sandstone) including removing. Spreading or stacking the spils within a lead of 75m. As directed. The item includes necessary trimming the sides of trenches, leveling dressing and ramming the bottom, bailing out water as required complete. (a) Depth of excavation not exceeding 1500 mm. 1.00 X 0.75 X 0.775 = 0.581	0.58	cu.m.	120.47	69.99
2	<b>P-11/I-1</b> Single Brick Flat Soling of picked jhama bricks including ramming and dressing bed to proper level and filling joints with local sand. 1.00X0.750=0.75	0.75	sq.m.	377.00	282.75
3	<b>P-11/I-4(a)</b> Cement concrete with graded jhama khoa(30 mm size) excluding shuttering. In ground floor and foundation. (a) (6:3:1) proportion 1.00x0.750x0.100=0.75	0.08	cu.m.	5803.00	435.23
4	<b>P-29/I-22(a)</b> Brick work with 1st class bricks in cement mortar (6:1) In foundation and plinth  1X1.00X0.250X0.600=0.15	0.15	cu.m.	5719.00	857.85
5	<b>P-31/I-29</b> 125 mm. thick brick work with 1st class bricks in cement mortar (1:4) in ground floor. 1X1.00X0.600=0.600	0.60	sq.m.	783.00	469.80
6	<b>P-151/I-2(i)(c)</b> Plaster (to wall, floor, ceiling etc.) with sand and cement mortar including rounding off or chamfering corners as directed and raking out joints including throating, nosing and drip course,scaffolding/staging where necessary (Ground floor).[Excluding cost of chipping over concrete surface] (ii) With 1:4 cement mortar (b) 15 mm thick plaster	1.88	sq.m.	156.00	292.50
7	<b>P-152/I-8</b> Neat cement punning about 1.5mm thick in wall,dado>window sill,floor etc.	1.88	sq.m.	38.00	71.44

8	P-1/I-3a Earth work in filling in foundation trenches or plinth with good earth, in layers not exceeding 150 mm. including watering and ramming etc. layer by layer complete. (Payment to be made on the basis of measurement of finished quantity of work) (a) With earth obtained from excavation of foundation. 0.75X0.600=0.45	0.45	cu.m	78.31	35.24
Total Rs.					2514.80

Say Rs. 2515.00

(Rupees Two thousand Five hundred & Fifteen only.) /Per m. Lenth

Type (C) Total Lenth 1282.70 m =Rs. 3225990.00

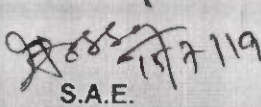
  
 S.A.E.  
 TAKI MUNICIPALITY

Sub-Asstt. Engineer  
TAKI MUNICIPALITY

  
 CHAIRMAN  
 TAKI MUNICIPALITY

Chairman  
Taki Municipality

SECTION OF MASONRY SURFACE DRAIN  
(300 MM X 600 MM) IN DIFFERENT WARDS  
UNDER TAKI MUNICIPALITY UNDER HFA(ID)



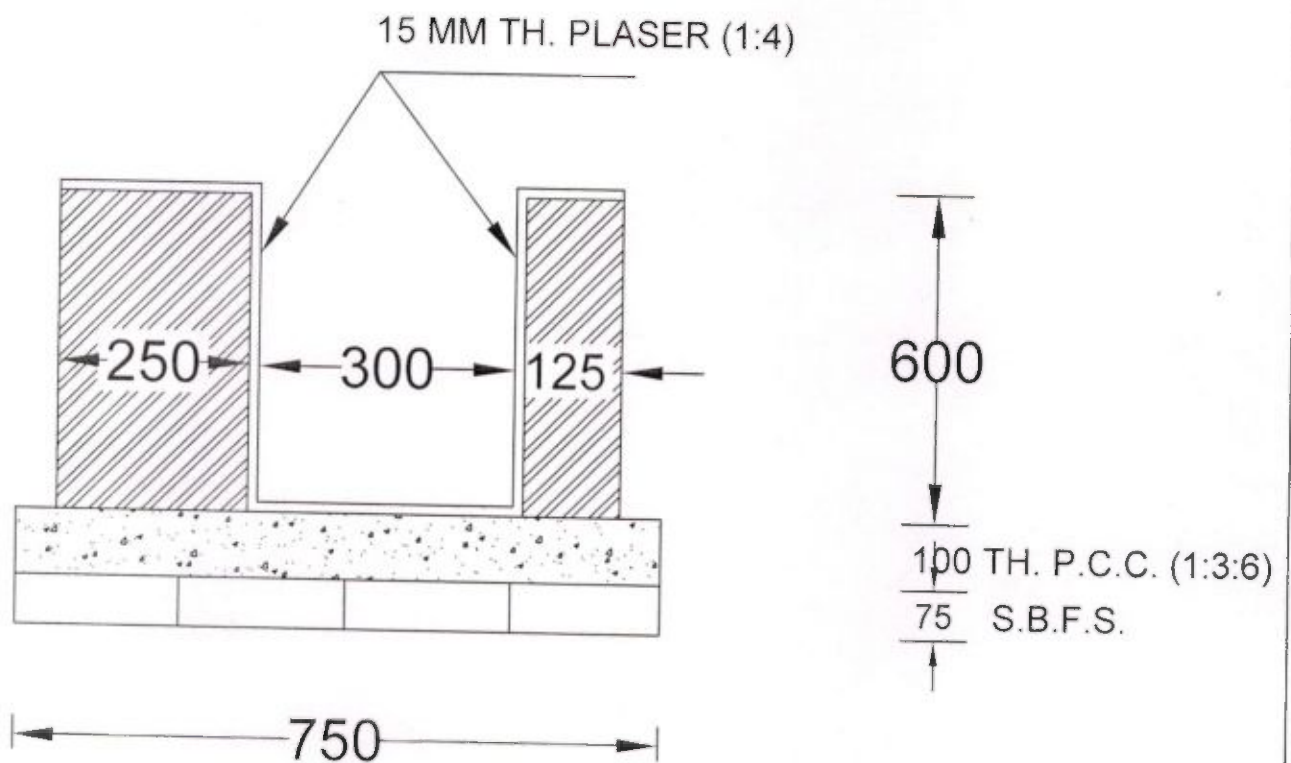





TYPE - C











SECTION OF MASONRY  
SURFACE DRAIN TYPE - C  
(300 MM X 600 MM)









*[Handwritten signature]*  
15/7/19

Sub-Asstt. Engineer  
TAKI MUNICIPALITY

Sl No.	Ward No	Slum/Non Slum	Name of the Beneficiary	Father's/ Husband's Name	Holding No. / Address	Category		Minority	Gender	Adhar No.	Mob No.	Bank Name	Branch	Bank Ac. No	Photo
						GENERAL/S.C/S.T./OBC	sc								
9	11	Hatath Coloni	Lakshmirani Mondal	Nityaranjan	356	sc	NO	F	876707764888	7602816939	SBI	Taki	34495888340		
10	11	Hatath Coloni	Madan Mohan Das	Lt. Narayan	654	Gen	NO	M	346835631913	7602722223	UBI	Hasnabad	0144010236225		
11	11	Ramkrishna palli	Ramprosad Mondal	Lt. Madar Mondal	765	sc	NO	M	476048791474	8513907301	SBI	Taki	31672389466		
12	11	Ramkrishna palli	Dipak gharemi	Monohar Gharami	716	Gen	NO	M	836012315927	9827288573	UBI	Hasnabad	0144010226370		
13	11	Hatath Coloni	Anita gain	Balai Gain	777	sc	NO	F	241909480744	8348371506	Allahabad	Kumarpukur	50402396130		
14	11	Hatath Coloni	Arobinda Mistry	Lt. kartick Mistry	848	sc	NO	M	269697327005	9609340148	UBI	Hasnabad	0144010158961		
15	11	Hatath Coloni	Deben Dhara	lt. Kanailal dhara	986	sc	NO	M	635414255637	9647161740	Allahabad	Kumarpukur	50482723018		
16	11	Hatath Coloni	Prasanta Das	Lt. Ajit Das	735	Gen	NO	M	754087787665	9093702366	SBI	Taki	35121701498		











Sl No.	Ward No	Slum/Non Slum	Name of the Beneficiary	Father's/ Husband's Name	Holding No. / Address	Category		Minority	Gender	Adhar No.	Mob No.	Bank Name	Branch	Bank Ac. No	Photo
						GENERAL/S.C/S.T./OBC									
17	11	Laskar Nagar	Mazed Goalpahari	Lt. Santosh Golpahari	261/2	Gen	YES	M	528470112776	9732792193	SBI	Taki	32223393658		
18	11	Laskar Nagar	Abdul Mondal	Lt. Aninuddin Mondal	447	Gen	YES	M	198066744942	9800684537	UBI	Hasnabad	0144010391825		
19	11	Rajipur	Abdul Kalam Mondal	Lt. Mansur Mondal	748	Gen	YES	M	201033885049	8001432862	SBI	Taki	31952745054		
20	11	Rajipur	Subrata Das	Lt. Baidyanath Das	832	Gen	NO	M	799712221665	9091655943	SBI	Taki	35089517346		
21	11	Jugla	Maya das Adhikari	Lt. biswajit adhikari	792	Gen	NO	F	915120148061	7548999577	Allahabad	Taki	50182007595		
22	11	Rajipur	Tapan Adhikary	Lt. Sudhanna Adhikary	210	Gen	NO	M	384019797341	9732975890	SBI	Taki	10608730614		
23	11	Rajipur	Animesh Ghosh	Lt. Dhadibushan ghosh	231	Gen	NO	M	587750047147	8515040066	UBI	Hasnabad	0144010529808		
24	11	Rajipur	Chittaranjan Mondal	Lt. Ajit Mondal	527	sc	NO	M	238501765955	7003117311	Allahabad	Taki	59163323621		

Sl No.	Ward No	Slum/Non Slum	Name of the Beneficiary	Father's/ Husband's Name	Holding No. / Address	Category		Minority	Gender	Adhar No.	Mob No.	Bank Name	Branch	Bank Ac. No	Photo
						GENERAL/S.C/S.T./OBC									
25	11	Rajipur	Ashoke Kumar Ghosh	Lt. Nanigopal Ghosh	103	Gen	NO	M	528602498331	9564092539	SBI	Taki	20002354821		
26	11	Rajipur	Arindam Chatterjee	Sunil Chatterjee	163	Gen	NO	M	768203708633	7602307922	SBI	Taki	31676602202		
27	11	Rajipur	Sunil Mondal	Megnath Mondal	761	sc	NO	M	521704701644	9167690933	SBI	Taki	36366577361		
28	11	Rajipur	Gurudas pathak	Lt. Ram Chandra Pathak	636	Gen	NO	M	291647606522	8250298404	Allahabad	Taki	21375550199		
29	11	Rajipur	Anirban Mondal	Lt. Manik Ch. Mondal	434	sc	NO	M	393206311303	8348435739	BOI	Taki	415818210000418		
30	11	Rajipur	Dilip Halidar	Bani Halidar	976	Gen	NO	M	412338774417	9088477176	Allahabad	Taki	59155088288		
31	11	Jugia	Dinabandhu Raptan	Lt. Surendra Raptan	214	sc	NO	M	438479722320	8609234143	SBI	Taki	36411083465		
32	11	Beokati	Sankar Kumar Ghosh	Lt. Ashoke Kumar ghosh	264	sc	NO	M	488586275236	9933448512	UBI	Hasnabad	0122010326861		









Chhatrapati  
Taki Municipality









Sl No.	Ward No	Slum/Non Slum	Name of the Beneficiary	Father's/ Husband's Name	Holding No. / Address	Category		Gender	Adhar No.	Mob No.	Bank Name	Branch	Bank Ac. No	Photo
						GENERAL/S.C/S .T./OBC	Minority							
33	11	Rajipur	Pradip sardar	Lt. Birendra Nath Sardar	851	GEN	NO	M	723883920317	8145382506	SBI	Taki	36289400571	









  
 Chelman  
 Taki Municipality









Sl No.	Ward No	Slum/Non Slum	Name of the Beneficiary	Father's/ Husband's Name	Holding No. / Address	Category		Minority	Gender	Adhar No.	Mob No.	Bank Name	Branch	Bank Ac. No	Photo
						GENeral/S.C/S.T./OBC									
1	12	NIKARI PARA	MACHJURA BIBI	RAFIKUL MONDAL	567	OBC	YES	F	644136313266	8670414511	UBI	HASNABAD	0144010527453		
2	12	KHALPAR PARA	BHARAT CH. BAR	KHIROD BAR	267/288	SC	NO	M	639713316915	7001544231	UBI	HASNABAD	0144010118488		
3	12	KHALPAR PARA	NARAYAN MONDAL	SADHAN MONDAL	277	SC	NO	M	970801527561	9749582443	ALLAHABAD	KUMARPURKUR	59136300729		
4	12	KHALPAR PARA	ANNA BAR	LT. HARIPADA BAR	276	SC	NO	M	684120303103	8509675260	BANGIYA GRAMIN VIKASH BANK	HASNABAD	5217010043616		
5	12	NIKARI PARA	SUMITRA DAS	NIRAPADA DAS	394/399	GEN	NO	F	759024452622	9733569557	UBI	HASNABAD	0144010355629		
6	12	KHALPAR PARA	JASHOPADA BAR	LT. MANMOTA BAR	349	SC	NO	M	761183512602	8172055045	SBI	TAKI	30175474558		
7	12	KHALPAR PARA	MAKHAN CH MONDAL	LT. RAKHAL CH. MONDAL	501	SC	NO	M	643875614281	8116179560	BANGIYA GRAMIN VIKASH BANK	HASNABAD	5217010001204		
8	12	BINODCOLONY	DEBAPROSAD BISWAS	LT. SHIBNATH BISWAS	238	OBC	NO	M	249569225330	8145385236	ALLAHABAD	TAKI	59127599626		

Chairman  
Taki Municipality

Sl No.	Ward No	Slum/Non Slum	Name of the Beneficiary	Father's/ Husband's Name	Holding No. / Address	Category		Gender	Adhar No.	Mob No.	Bank Name	Branch	Bank Ac. No	Photo
						GENERAL/ S.C/S.T./OBC	Minority							
9	12	BINODCOLONY	HEMANTO ROY	KANA LAL ROY	208	SC	NO	M	463996476686	9851123627	UBI	HASNABAD	0144010111595	
10	12	IDGA PARA	SANKAR MONDAL	LT. SATISH CH. MONDAL	158	SC	NO	M	767413627051	7584089060	ALLAHABAD	KUMARPUKUR	59140469076	
11	12	IDGA PARA	ANJALI NATH	CHITTARANJAN NATH	26/27	OBC	NO	F	724108384177	9832267888	UBI	HASNABAD	0144010118601	
12	12	BINODCOLONY	BHASKAR MONDAL	LT. KHUDIRAM MONDAL	184	SC	NO	M	227095340722	9851188544	UBI	HASNABAD	0144010241977	
13	12	BINODCOLONY	PARITOSH MONDAL	LT. BHUSAN MONDAL	212	SC	NO	M	851849905647	8945823244	ALLAHABAD	KUMARPUKUR	22258532314	
14	12	BINODCOLONY	NINAI BISWAS	LT. BISHNUPADA MONDAL	70/66	SC	NO	M	773867455756	9593437355	UBI	HASNABAD	0144010410137	
15	12	BINODCOLONY	AMIYA BISWAS	LT. HARIPADA BISWAS	318	SC	NO	M	315332714424	9775565265	UBI	HASNABAD	0144010245968	
16	12	BINODCOLONY	ABHASH MONDAL	LT. KHUDIRAM BISWAS	184	SC	NO	M	810213221477	8001430938	ALLAHABAD	KUMARPUKUR	59136376245	









SI No.	Ward No	Slum/Non Slum	Name of the Beneficiary	Father's/ Husband's Name	Holding No. / Address	Category		Gender	Adhar No.	Mob No.	Bank Name	Branch	Bank Ac. No	Photo
						GENERAL/S.C./S.T./OBC	Minority							
17	12	BINODCOLONY	MAYA MONDAL	LT. BISHTUPADA MONDAL	208	SC	NO	F	530534695314	8670566772	ALLAHABAD	KUMARPUKUR	22258637656	
18	12	BINODCOLONY	KALIDASHI MONDAL	LT. PARAN MONDAL	218	SC	NO	F	497916841057	8670196384	ALLAHABAD	KUMARPUKUR	22258637894	
19	12	BINODCOLONY	KANAILAL SARKAR	LT. BISHTUPADA SARKAR	179	SC	NO	M	666526359671	9732787557	UBI	HASNABAD	0144010104392	
20	12	KHALPAR PARA	CHANDRA KUMAR DAS	LT. ASHOKE DAS	256	OBC	NO	M	710882735530	9083588591	UBI	HASNABAD	0144010390439	
21	12	KHALPAR PARA	BASANTI MAKHAL	SHANKAR MAKHAL	236	SC	NO	F	917004093487	8609860004	SBI	TAKI	36138613062	
22	12	BINODCOLONY	SUDIP RAY	LT. RAMDAS RAY	205	SC	NO	M	393515111067	6295958859	SBI	TAKI	31613867309	
23	12	IDGA PARA	BHASKAR NATH	RANJAN KR. NATH	75	OBC	NO	M	450257974145	8145280411	SBI	TAKI	34491840107	
24	12	BINODCOLONY	MAHADEB DAS	MADHUSUDAN DAS	647	SC	NO	M	292855068907	8768863018	SBI	TAKI	30046406611	









Sl No.	Ward No	Slum/Non Slum	Name of the Beneficiary	Father's/ Husband's Name	Holding No. / Address	Category		Minority	Gender	Adhar No.	Mob No.	Bank Name	Branch	Bank Ac. No	Photo
						General/S.C/S.T./OBC									
25	12	KHALPAR PARA	SURYA KR. MONDAL	SURENDRANATH MONDAL	578	SC		NO	M	798884436959	9134274763	SBI	TAKI	34707031194	
26	12	KHALPAR PARA	SHANU BIBI	MIRAN GAZI	524	OBC		YES	F	552186928265	9609079639	UBI	HASNABAD	0144010589147	
27	12	IDGA PARA	MAMATA BISWAS	ADIP BISWAS	35	OBC		NO	F	619032894745	8343877343	SBI	TAKI	35661734804	
28	12	KHALPAR PARA	RANJIT MONDAL	LT. SARAT MONDAL	272	SC		NO	M	568597439697	9134345051	SBI	TAKI	32710894431	
29	12	BINODCOLONY	SANTA MONDAL	LT. HARIDAS MONDAL	169	SC		NO	F	767602127694	8768708238	ALLAHABAD	KUMARPUKUR	22258582366	
30	12	IDGA PARA	NURAN GAZI	LT. KANAI GAZI	82	OBC		YES	F	737381595390	9845825622	ALLAHABAD	KUMARPUKUR	22258637861	
31	12	IDGA PARA	SHIBANI NATH	BIJAY KRISHNA NATH	14/15	OBC		NO	F	976712725353	8768732847	ALLAHABAD	TAKI	21375576059	
32	12	NIKARI PARA	RAMJAN MONDAL	LT. DEENMAHAMMAD MONDAL	387	OBC		YES	M	749078974638	9609390251	ALLAHABAD	KUMARPUKUR	50099212486	









Sl No.	Ward No	Slum/Non Slum	Name of the Beneficiary	Father's/ Husband's Name	Holding No. / Address	Category		Gender	Adhar No.	Mob No.	Bank Name	Branch	Bank Ac. No	Photo
						General/S.C/S.T./OBC	Minority							
1	13	NIKARI PARA	MALEK MOLLA	MURAD MOLLA	83	OBC	YES	M	849482261318	7384183445	S.B.I	TAKI	33013888123	
2	13	NIKARI PARA	MOKBUL AHAMED GAZI	ANOWAR HOSSAIN	108	OBC	YES	M	570491245116	8514062268	S.B.I	TAKI	34733416731	
3	13	MUSZID PARA	MOKCHED SARDAR	KESAM SARDAR	52	OBC	YES	M	452045287364	7908897770	ALLAHABAD	KUMARPUKUR	50327804216	
4	13	NATH PARA	ATIYAR MONDAL	ROMJAN MONDAL	189	OBC	YES	M	974992623095	8145123776	U.B.I	HASNABAD	14401036006	
5	13	NIKARI PARA	LAILI MONDAL	LT. ICHHAQUE MONDAL	42	OBC	YES	F	543363413478	7679981123	ALLAHABAD	KUMARPUKUR	50175284434	
6	13	MUSZID PARA	TASLIMA LASKAR	ABDUL MANNAN	505	OBC	NO	F	340691880570	7908897770	ALLAHABAD	KUMARPUKUR	22258631155	
7	13	KHRAN PARA	KRIPA NATH	NARYAN CHANDRA	336	OBC	NO	M	977394695348	7699050158	U.B.I	HASNABAD	0144010419765	
8	13	MUSZID PARA	MAJEDA BIBI	LT KARIM MONDAL	209	OBC	YES	F	376171093588	7384183445	U.B.I	HASNABAD	0144010336451	

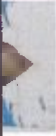







Chairman  
Taki Mahila



















Sl No.	Ward No	Slum/Non Slum	Name of the Beneficiary	Father's/ Husband's Name	Holding No. / Address	Category		Gender	Adhar No.	Mob No.	Bank Name	Branch	Bank Ac. No	Photo
						General/S.C/S.T./OBC	Minority							
9	13	NIKARI PARA	LUTFAR GAZI	DADUD GAZI	156	OBC	YES	M	297567997236	8609263627	S.B.I	TAKI	31149415597	
10	13	NIKARI PARA	NURUL GAZI	ROMJAN GAZI	82	OBC	YES	M	471504398461	6295965660	S.B.I	TAKI	34060758744	
11	13	NIKARI PARA	HAYAT ALI GAZI	NAZRUL HAQUE	196	OBC	YES	M	601464215948	7384183445	B.O.I	TAKI	415810110001919	
12	13	NIKARI PARA	ACHHIYA GAZI	AMIR ABDULLA	48	GEN	YES	F	470675875316	7689981123	S.B.I	TAKI	30044483120	
13	13	MUSZID PARA	SWARUP DAS	LT.SUNIL DAS	203	GEN	NO	M	605993405578	9732707149	S.B.I	TAKI	31085992405	
14	13	MUSZID PARA	PRABHATI DALAL	TAPAN DALAL	206	OBC	NO	F	335839961628	9593071390	S.B.I	TAKI	32635721854	
15	13	KHARAN PARA	SANCHIYA NATH	GANESH CH. NATH	105	OBC	NO	F	51466217640	9733549197	U.B.I	HASNABAD	0144010351720	
16	13	DALAL PARA	TAPAN DALAL	SUKUMAR DALAL	307	OBC	NO	M	956309585431	7684184532	S.B.I	TAKI	34491823307	

Sl No.	Ward No	Slum/Non Slum	Name of the Beneficiary	Father's/ Husband's Name	Holding No. / Address	Category		Minority	Gender	Adhar No.	Mob No.	Bank Name	Branch	Bank Ac. No	Photo
						General/S.C/S.T./OBC									
17	13	MUSZID PARA	ROKEYA BIBI	ABU HOSEN MONDAL	92	GEN	YES	F	623372910750	9965845124	S.B.I	TAKI	20436470675		
18	13	NATH PARA	SUJIT NATH	PURNASASHI NATH	242	OBC	NO	M	358623286325	9932526542	S.B.I	TAKI	30244258982		
19	13	NIKARI PARA	MAYAMANA GAZI	SAHIDAR RAHAMAN	188	OBC	YES	F	340351278640	9932526522	ALLAHABAD	KUMARPUKUR	50176266388		
20	13	NIKARI PARA	MIRA BIBI MONDAL	MD ANICHAH ROHAMAN	193	OBC	YES	F	535259859570	7395864751	ALLAHABAD	KUMARPUKUR	50176278456		
21	13	NIKARI PARA	ALTAP SARDAR	HANIF SARDAR	185	OBC	YES	M	467702552029	9933114572	U.B.I	HASNABAD	0144010216722		
22	13	NIKARI PARA	MASUD ALI GAZI	MADU ALI	49	OBC	YES	M	706605055961	9932625621	ALLAHABAD	KUMARPUKUR	50176288456		
23	13	DALAL PARA	RANUBALA DALAL	MANIK DALAL	387	OBC	NO	F	944047083639	9564192527	U.B.I	HASNABAD	0144010395700		
24	13	DALAL PARA	SARBAMANGAL A NATH	BISWAJIT	76	OBC	NO	F	702159059299	9855214621	S.B.I	TAKI	34733417349		

Sl No.	Ward No	Slum/Non Slum	Name of the Beneficiary	Father's/ Husband's Name	Holding No. / Address	Category		Gender	Adhar No.	Mob No.	Bank Name	Branch	Bank Ac. No	Photo
						General/S.C/S.T./OBC	Minority							
1	14	HASNABAD STATION PARA	DURGA SARKAR	MAHADEB SARKAR	821	SC	NO	F	314010610603	8001429635	ALLAHABAD	KUMARPUKUR	50482039650	
2	14	HASNABAD STATION PARA	KHOKAN RAY	SADHUCHARAN RAY	752	SC	NO	M	648757086076	7719292242	S.B.I	TAKI	35356132057	
3	14	HASNABAD STATION PARA	NILA SIL	RANJIT SIL	756	OBC	NO	F	447461682231	9681386537	ALLAHABAD	KUMARPUKUR	22258639529	
4	14	LASKAR NAGAR	DILIP MONDAL	LT. THAKUR CH. MONDAL	178	SC	NO	M	753025897791	9679121427	S.B.I	TAKI	34001768559	
5	14	BURMA PARA	BISWAJIT MONDAL	JAMINI MONDAL	626	SC	NO	M	849809165847	8317872828	S.B.I	TAKI	38341330892	
6	14	BADAM TALA	MOKTAR GAZI	LT. SYED GAZI	340	OBC	YES	M	854933371860	8327489633	U.B.I	HASNABAD	0144010434256	
7	14	HASNABAD STATION PARA	ANIL GAYEN	LT. PACHU RAM GAYEN	327	SC	NO	M	765665495458	9732959503	S.B.I	TAKI	30865954449	
8	14	MURIHAT	RANJAN BISWAS	LT. PURANDAR BISWAS	609	SC	NO	M	700113445210	9609569334	S.B.I	TAKI	35059898347	

Sl No.	Ward No	Slum/Non Slum	Name of the Beneficiary	Father's/ Husband's Name	Holding No. / Address	Category		Gender	Adhar No.	Mob No.	Bank Name	Branch	Bank Ac. No	Photo
						GENERAL/S.C/S.T./OBC	Minority							
9	14	BADAM TALA	SAFIUL MONDAL	LT.GOLAM MONDAL	580	OBC	YES	M	962030645569	9593303698	U.B.I	HASNABAD	0144010622769	
10	14	LASKAR NAGAR	KALPANA MONDAL	LT. BIMOL MONDAL	485	SC	NO	F	503139571136	9800874419	S.B.I	TAKI	32774709687	
11	14	LASKAR NAGAR	HARIDAS ADHIKARY	LT. TARAK CH. ADHIKARY	268	GEN	NO	M	608941646347	9733274192	ALLAHABAD	KUMARPUKUR	50440187201	
12	14	HASNABAD STATION PARA	HARENDRA MONDAL	LT. MADER CH.MONDAL	127	SC	NO	M	907662934499	9735287805	S.B.I	TAKI	32104218695	
13	14	HASNABAD STATION PARA	SANKAR MONDAL	PARES MONDAL	625	SC	NO	M	994134696456	8104481739	B. G. V. B	HASNABAD	5217010008301	
14	14	HASNABAD STATION PARA	SARASWATI SARDAR	DEBI SARDAR	610	SC	NO	F	785442970581	8345952255	U.B.I	HASNABAD	0144010434904	
15	14	BADAM TALA	AJGAR GAZI	LT. SAIED GAZI	341	OBC	YES	M	552005127797	8388051928	S.B.I	TAKI	10608726234	
16	14	BURMA PARA	KIRAN DEY	BABUL DEY	623	OBC	NO	F	234799178258	9635229740	ALLAHABAD	KUMARPUKUR	22258637667	









Sl No.	Ward No	Slum/Non Slum	Name of the Beneficiary	Father's/ Husband's Name	Holding No. / Address	Category		Gender	Adhar No.	Mob No.	Bank Name	Branch	Bank Ac. No	Photo
						GENERAL/S.C/S.T./OBC	Minority							
17	14	HASNABAD STATION PARA	CHABI MALLIK	LT. NIRAN MALLIK	840	SC	NO	F	909870188818	8906685371	ALLAHABAD	KUMARPUKUR	22258639518	
18	14	GHOSH PARA	SHAMBHU NATH GHOSH	LT. HAZARI LAL GHOSH	88	OBC	NO	M	738687798905	9564633265	S.B.I	TAKI	11000605175	
19	14	BADAM TALA	NURUL GAZI	LT. ABDUR RAHAMAN GAZI	418	OBC	YES	M	656065630828		U.B.I	HASNABAD	0144010115252	
20	14	HASNABAD STATION PARA	SHEELA BAWALI	CHITTARANJAN BAWALI	926	SC	NO	F	432320435237	7074532738	U.B.I	HASNABAD	0144010539524	
21	14	GHOSH PARA	RAMESHWAR GHOSH	LT. PURNA CH. GHOSH	80	OBC	NO	M	940239834075	9647430268	S.B.I	TAKI	32143230503	
22	14	HASNABAD STATION PARA	NILKAMAL RAY	LT. SADHU CH. RAY	963	SC	NO	M	605241960200	9851373585	U.B.I	HASNABAD	0144010144698	
23	14	RAMKRISHNA PALLY	SUBODH DUTTA	RASHBIHARI DUTTA	694	GEN	NO	M	264752769078	9775254069	ALLAHABAD	KUMARPUKUR	50490688492	
24	14	SHANTI COLONY	SANKAR MONDAL	LT. BHUPESH MONDAL	580	SC	NO	M	973265295088	9002269170	S.B.I	TAKI	33428380924	

Sl No.	Ward No	Slum/Non Slum	Name of the Beneficiary	Father's/ Husband's Name	Holding No. / Address	Category		Gender	Adhar No.	Mob No.	Bank Name	Branch	Bank Ac. No	Photo
						GENeral/S.C/S.T./OBC	Minority							
25	14	BURMA PARA	BIBHASH ROY	LT. NIRANJAN ROY	563	SC	NO	M	649178455325	7076445135	B. O. I	TAKI	415818214444176	
26	14	HASNABAD STATION PARA	RIPAN JOTDAR	DURGA PADA JOTDAR	852	SC	NO	M	356812604222	7031803479	S.B.I	TAKI	33128945682	
27	14	PASCHIM PARA	SIRAJUL MONDAL	LT. KABIL MONDAL	7	OBC	NO	M	758151862797	9733884233	ALLAHABAD	KUMARPUKUR	59112909772	
28	14	HASNABAD STATION PARA	NURALI GAZI	LT. MANIRUDDIN GAZI	111	OBC	YES	M	495671805621	7699410790	ALLAHABAD	KUMARPUKUR	22258585334	
29	14	BURMA PARA	BISHU CHOWDHURI	LT. MATIAL CHOWDHURI	989	GEN	NO	M	681154962705	9091907145	B. O. I	TAKI	415818210000390	
30	14	HASNABAD STATION PARA	RAHILA BIBI	RAFIKUL	405	GEN	YES	F	326275143099	9091229925	ALLAHABAD	KUMARPUKUR	50386901526	
31	14	HASNABAD STATION PARA	MAFUJA BIBI	ARIJUL GAZI	636	OBC	YES	F	225284231920	9002711509	ALLAHABAD	KUMARPUKUR	50382368884	
32	14	GHOSH PARA	DOLI GHOSH	KENA PADA GHOSH	98	OBC	NO	F	454431236293	9932728046	S.B.I	TAKI	30230617358	









Chairman  
TAKI MUNICIPALITY







Sl No.	Ward No	Slum/Non Slum	Name of the Beneficiary	Father's/ Husband's Name	Holding No. / Address	Category		Minority	Gender	Adhar No.	Mob No.	Bank Name	Branch	Bank Ac. No	Photo
						General/S.C/S.T./OBC									
33	14	HASNABAD STATION PARA	CHITTARANJAN MONDAL	LT. PANCHANAN MONDAL	743	SC	NO	M	777997263341	9733004716	U.B.I	HASNABAD	0144010158930		







*Chairman*  
TAKI MUNICIPALITY







Sl No.	Ward No	Slum/Non Slum	Name of the Beneficiary	Father's/ Husband's Name	Holding No. / Address	Category		Gender	Adhar No.	Mob No.	Bank Name	Branch	Bank Ac. No	Photo
						GENERAL/S.C/S.T./OBC	Minority							
1	15	Non-Slum	Narayan Chandra Ghosh	Nagendranath Ghosh	140	Gen	NO	M	679439798880	8967620495	SBI	Taki	31849253718	
2	15	Non-Slum	Bandana Ghosh	Nilkamal Ghosh	5	Gen	NO	F	497314150756	9733211130	UBI	Hasnabad	0 144010408578	
3	15	Non-Slum	Mithilesh Gupta	Debiprasad Gupta	185	Gen	NO	M	640479908984	8967161177	SBI	Taki	30488726125	
4	15	Non-Slum	Bhojahari Ghosh	Gokul Ghosh	12	Gen	NO	M	330413489008	8670568379	Allahabad	Kumarpuur	59127214515	
5	15	Non-Slum	Biswanath Adhikary	Netai Adhikary	775	Gen	NO	M	223996173111	8609840614	Allahabad	Kumarpuur	50486275470	
6	15	Non-Slum	Chitta Mondal	Ishani Mondal	113	SC	NO	M	628499506310	7501164188	SBI	Taki	10608719409	
7	15	Non-Slum	Bhola Mondal	Bhupen Mondal	841	SC	NO	M	298222424468	9732619010	UBI	Hasnabad	0 144010237802	
8	15	Non-Slum	Azizul Gazi	Karimbox Gazi	828	Gen	YES	M	750908649472	9732596633	UBI	Hasnabad	0 144010116158	









Sl No.	Ward No	Slum/Non Slum	Name of the Beneficiary	Father's/ Husband's Name	Holding No. / Address	Category		Gender	Adhar No.	Mob No.	Bank Name	Branch	Bank Ac. No	Photo
						GENERAL/S.C/S.T./OBC	Minority							
9	15	Non- Slum	Sagarika Saha	Sadhan Kumar Saha	757	Gen	NO	F	341239448737	9614491671	SBI	Taki	30131720391	
10	15	Non- Slum	Abdul Kader Gazi	Karim Boksh Gazi	731	Gen	YES	M	749666966193	9734400737	Allahabad	Kumarpukur	21375578681	
11	15	Non- Slum	Gopal Biswas	Girish Biswas	195	Gen	NO	M	471209178696	9733640995	Allahabad	Kumarpukur	59153343491	
12	15	Non- Slum	Fajer Ali Gazi	Sultan Gazi	716	Gen	YES	M	568294755248	9093382571	UBI	Hasnabad	0 144010367837	
13	15	Non- Slum	Hiranmoy Das	Kanti Ranjan Das	236	SC	NO	M	835320390589	7602352030	UBI	Hasnabad	0 144010117246	
14	15	Non- Slum	Afsar Ali Gazi	Karim box Gazi	731	Gen	YES	M	288422377139	6297186242	Allahabad	Kumarpukur	50298716033	
15	15	Non- Slum	Santosh Mondal	Abhilash Mondal	205	SC	NO	M	581108370517	95643406651	SBI	Taki	34733418036	
16	15	Non- Slum	Rajib Ghosh	Kamal Ghosh	16	Gen	NO	M	280585103431	7098123981	UBI	Hasnabad	0 144010142588	

Sl No.	Ward No	Slum/Non Slum	Name of the Beneficiary	Father's/ Husband's Name	Holding No. / Address	Category		Gender	Adhar No.	Mob No.	Bank Name	Branch	Bank Ac. No	Photo
						GENERAL/S.C/S.T./OBC	Minority							
1	16	SUBHAS NAGAR	ANIL MONDAL	LT. JOGENDRA MONDAL	935	SC	NO	M	958324480323	8343009070	ALLAHABAD	KUMARPUKUR	22258529979	
2	16	BINOD COLONY	KRISHNAPADA BAINAV	AJIT KUMAR BAINAV	809	SC	NO	M	945123448475	7908950141	S. B. I	TAKI	31944612386	
3	16	BINOD COLONY	KUMUDRANJAN BISWAS	UPENDRA BISWAS	854	SC	NO	M	842706373329	9333464635	U. B. I	HASNABAD	0144010118472	
4	16	BINOD COLONY	AMENA GAZI	SAJAK GAZI	134	OBC	YES	F	774320703552	7602927808	U. B. I	HASNABAD	0144010403597	
5	16	BINOD COLONY	UMA BISWAS	RAJKUMAR BISWAS	862	SC	NO	F	263041206700	8436424479	U. B. I	HASNABAD	0144010435857	
6	16	BINOD COLONY	BABU ROY	NETAI ROY	201	SC	NO	M	584750272063	9735578772	U. B. I	HASNABAD	0144010403313	
7	16	BINOD COLONY	SULATA MONDAL	RAMPRASAD MONDAL	580	SC	NO	F	679719909653	8001605334	BANDHAN	BASIRHAT	50150022341523	



Sl No.	Ward No	Slum/Non Slum	Name of the Beneficiary	Father's/ Husband's Name	Holding No. / Address	Category		Gender	Adhar No.	Mob No.	Bank Name	Branch	Bank Ac. No	Photo
						GENERAL/S.C/S.T./OBC	Minority							
8	16	SUBHAS NAGAR	PURNIMA MONDAL	LT. RAJU MONDAL	907	SC	NO	F	943682846217	8670541063	U. B. I	HASNABAD	0144010431064	
9	16	BINOD COLONY	TAPAN GHOSH	SUKUMAR GHOSH	548	GEN	NO	M	664436994977	9679700444	U. B. I	HASNABAD	0144010433907	
10	16	BINOD COLONY	HARIDAS SARKAR	ANANTA SARKAR	251	SC	NO	M	405457192449	6294633891	U. B. I	HASNABAD	0144010437042	
11	16	SUBHAS NAGAR	JAGADHATRI GHOSH	PRASANTA GHOSH	116	GEN	NO	F	602630818958	8972615023	ALLAHABAD	KUMARPUKUR	222582515	
12	16	HASNABAD	JUGAL ADHIKARY	GYANENDRA NATH ADHIKARY	119	GEN	NO	M	496989507974	7551888980	S. B. I	TAKI	11000659461	
13	16	BINOD COLONY	RANJAN BISWAS	LT. THAKUR CHARAN BISWAS	568/600	SC	NO	M	759786969830	9093126293	U. B. I	HASNABAD	0144010221498	
14	16	BINOD COLONY	SANJAY SARDAR	LT. DADHIRAM SARDAR	833	SC	NO	M	779061387070	8972317844	U. B. I	HASNABAD	0144010109971	





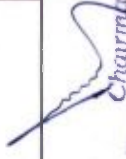



Sl No.	Ward No	Slum/Non Slum	Name of the Beneficiary	Father's/ Husband's Name	Holding No. / Address	Category		Gender	Adhar No.	Mob No.	Bank Name	Branch	Bank Ac. No	Photo
						General/S.C/S.T./OBC	Minority							
15	16	BINOD COLONY	BABURAM SARKAR	KALIPADA SARKAR	518	SC	NO	M	466831956623	8637332758	U. B. I	HASNABAD	0144010238014	
16	16	RAJIPUR HASNABAD	ABDUL MAJED GAZI	PARAN GAZI	54	OBC	YES	M	934047954167	9635531717	ALLAHABAD	KUMARPURKUR	50174324162	
17	16	BINOD COLONY	GOBINDA MONDAL	LT. BIMAL KRISHNA MONDAL	803	SC	NO	M	346114318373	8609293735	U. B. I	HASNABAD	0144010511636	
18	16	SUBHAS NAGAR	NIRMAL GHOSH	LT. SATISH GHOSH	552	GEN	NO	M	738710057827	9333464635	ALLAHABAD	KUMARPURKUR	50244932308	
19	16	SUBHAS NAGAR	PRATIMA DEBNATH	DILIP DEBNATH	108	GEN	NO	F	990782952567	8609293755	U. B. I	HASNABAD	0144010436908	
20	16	BINOD COLONY	SHANTI DAS	LT. HARIPADA DAS	481	GEN	NO	F	465872275695	9333464635	U. B. I	HASNABAD	0144010433402	
21	16	BINOD COLONY	SOMA MONDAL	DIPAK MONDAL	224	SC	NO	F	925209940707	9333464635	U. B. I	HASNABAD	0144010419055	



  
Chairman  
TAKI MUNICIPALITY

Sl No.	Ward No	Slum/Non Slum	Name of the Beneficiary	Father's/ Husband's Name	Holding No. / Address	Category		Gender	Adhar No.	Mob No.	Bank Name	Branch	Bank Ac. No	Photo
						General/S.C/S.T./OBC	Minority							
22	16	BINOD COLONY	MADAN GHOSH	LT. SATYACHARAN GHOSH	480	GEN	NO	M	276516479745	8967368084	U. B. I	HASNABAD	0144010431361	
23	16	SUBHAS NAGAR	SHYAM SUNDAR GHOSH	LT. ANIL GHOSH	967	GEN	NO	M	945999463556	9563172731	U. B. I	HASNABAD	0144010114559	
24	16	BINOD COLONY	PUSPARANI BISWAS	CHANDRA SEKHAR BISWAS	721	SC	NO	F	264140472050	7063046525	ALLAHABAD	KUMARPUKUR	50368272599	
25	16	BINOD COLONY	RABINDRANATH PARAMANYA	LT. GOSTHABIHARI PARAMANYA	37	SC	NO	M	618080240296	9333464635	U. B. I	HASNABAD	0144010104974	
26	16	BINOD COLONY	SAHADEB SARKAR	LT. BAUL CH. SARKAR	886	SC	NO	M	221783929284	8609310571	S. B. I	TAKI	36999413630	
27	16	HASNABAD	ARUN DAS	LT. DHIRENDRA NATH DAS	202	GEN	NO	M	386019003785	9732634996	U. B. I	HASNABAD	0144010112154	
28	16	HASNABAD	SIKHA DAS	KHAGENDRA NATH DAS	56	GEN	NO	F	305815422580	8001247077	U. B. I	HASNABAD	0144010397681	

  
 Chairman  
**TAKI MUNICIPALITY**









Sl No.	Ward No	Slum/Non Slum	Name of the Beneficiary	Father's/Husband's Name	Holding No. / Address	Category		Gender	Adhar No.	Mob No.	Bank Name	Branch	Bank Ac. No	Photo
						General/S.C/S.T./OBC	Minority							
29	16	BINOD COLONY	KARTICK PAL	ANIL PAL	547	GEN	NO	M	501322944210	9333464635	U. B. I	HASNABAD	0144010111687	
30	16	BINOD COLONY	BAISHAKHI NATH ROY	NEMAI CHANDRA ROY	37	SC	NO	F	518627763703	8293488018	B. G. V. B	HASNABAD	5217010020864	
31	16	BINOD COLONY	GOBINDA PARAMANYA	LT. BHAGABAN PARAMANYA	18	SC	NO	M	993080669298	9333464635	ALLAHABAD	KUMARPUKUR	59136942065	
32	16	BINOD COLONY	HARI GHOSH	LT. BISHNUPADA GHOSH	908	GEN	NO	M	270837257364	9609568958	ALLAHABAD	KUMARPUKUR	22258533088	
33	16	Non- Slum	Prosenjit Nath	Jaydeb Nath		Gen	NO	M	399753962157	9732842811	SBI	Taki	36028642689	
34	16	Non- Slum	Basanti Biswas	Gour Biswas	846	Gen	NO	F	632817606073	9733491303	Allahabad	Kumarpukur	59170134612	

Sl No.	Ward No	Slum/Non Slum	Name of the Beneficiary	Father's/ Husband's Name	Holding No. / Address	Category		Gender	Adhar No.	Mob No.	Bank Name	Branch	Bank Ac. No	Photo
						GENERAL/S.C/S.T./OBC	Minority							
25	7	Non Slum	Amit Pal	Lt. Panchanan pal	514	Gen	No	M	560246318987	9851854599	S.B.I	Taki	33009204025	
26	7	Non Slum	Shanti Mondal	Pagol Mondal	102	SC	No	M	361849076722	9562558624	Allahabad Bank	Taki	21375547472	
27	7	Non Slum	Dinabandhu Das	Tarapada Das	141	Gen	No	M	411510788034	9232153490	Allahabad Bank	Taki	50098634533	
28	7	Non Slum	Sadananda Das	Lt. Haricharan Das	136	Gen	No	M	624666571875	9614866365	Allahabad Bank	Taki	39056000024	
29	7	Non Slum	Bijoy Kumar Das	Late Chanchal Das	148	SC	No	M	595974540320	8514023004	U.B.I	Hasnabad	144010107471	
30	7	Non Slum	Kalpana Paul	Late Panchu Gopal Paul		Gen	No	F	640803200894	8573043994	B.O.I	Taki	437510110004646	
31	7	Non Slum	Ramchandra Das	Late Nirmal Kumar Das	758	Gen	No	M	945194679951	8972440154	B.O.I	Taki	41581011000	
32	7	Non Slum	Munmun Ghosh	Gurudas Ghosh	931	SC	No	F	319645015285	9800281870	Allahabad Bank	Taki	21375548523	









Sl No.	Ward No	Slum/Non Slum	Name of the Beneficiary	Father's/ Husband's Name	Holding No. / Address	Category		Gender	Adhar No.	Mob No.	Bank Name	Branch	Bank Ac. No	Photo
						GENERAL/S.C/S .T./OBC	Minority							
33	7	Non Slum	Narayan Mondal	Netai Mondal		Sc	No	M	432850462133	6296173272	Allahabad Bank	Taki	21375572179	
34	7	Non- Slum	Bijali Das	Gour Das	805	Gen	NO	F	585926180434	7501685232	UBI	Hasnabad	0 144010347044	









  
Chairman  
Taki Municipality











Sl No.	Ward No	Slum/Non Slum	Name of the Beneficiary	Father's/ Husband's Name	Holding No. / Address	Category		Gender	Adhar No.	Mob No.	Bank Name	Branch	Bank Ac. No	Photo
						GENERAL/S.C/S.T./OBC	Minority							
1	8	Slum	Nirmal Rishidas	Saheb Rishidas	59	SC	No	M	525185916240	9932275994	Allahabad Bank	Taki	50098364235	
2	8	Slum	Kalinarayan Das	Lt. Radhanath Das	58	SC	No	M	334113382296	8585007720	U.B.I	Hasnabad	144010110647	
3	8	Slum	Aparna Bhattacharyya	Kalipada Bhattacharyya	63/3493	Gen	No	F	229631387468	7384066239	Allahabad Bank	Taki	50178528231	
4	8	Slum	Ujjwal Mondal	Krishnapada Mondal	507	SC	No	M	947722162518	6296996622	Allahabad Bank	Taki	59136759126	
5	8	Slum	Rupa Banerjee	Netai banerjee	655	Gen	No	F	318402151176	9932465785	Allahabad Bank	Taki	50223772879	
6	8	Slum	Gour Rishidas	Lt. Kanai Rishidas	172	SC	No	M	429923762058	8145100776	Allahabad Bank	Taki	59147990143	
7	8	Slum	Mahesweta Chakraborty	Subhashish Chakraborty		Gen	No	F	284542923880	8371850056	Indian Bank	Itinda Road	6570439602	
8	8	Slum	Sankar Rishidas	Lt. Kalipada Rishidas	28	SC	No	M	231209414255	9083371339	Allahabad Bank	Taki	50209371568	

Chakraborty  
Taki Municipality

Sl No.	Ward No	Slum/Non Slum	Name of the Beneficiary	Father's/ Husband's Name	Holding No. / Address	Category		Gender	Adhar No.	Mob No.	Bank Name	Branch	Bank Ac. No	Photo
						GENERAL/S.C/S.T./OBC	Minority							
9	8	Slum	Banka Rishidas	Lt. kenaram Rishidas	7	SC	No	M	980908862257	9547350206	S.B.I	Taki	31425743284	
10	8	Slum	Joydeb Rishidas	Lt. Mongol Rishidas	695	SC	No	M	492640636515	9563747994	Allahabad Bank	Taki	59056274708	
11	8	Slum	Dulal Rishidas	Lt. kenaram Rishidas	7	SC	No	M	367246914445	9064186330	Allahabad Bank	Taki	59056500278	
12	8	Slum	Phanibhusan Rishidas	Lt. Haripada Rishidas		SC	No	M	750834878408	9932465785	Allahabad Bank	Taki	50049816985	
13	8	Slum	Nirupam Das	Lt. Tarapada Das	119	SC	No	M	89980031795	9932465785	S.B.I	Taki	87272422482	
14	8	Slum	Goutam Rishidas	Shaktipada Rishidas	800	SC	No	M	332002333685	9647073616	Allahabad Bank	Taki	50099451661	
15	8	Slum	Chandan mitra	Lt. kalipada Mitra	190	Gen	No	M	741253663766	9932465785	Allahabad Bank	Taki	50137405580	
16	8	Slum	Sanat Rishidas	Lt. Haripada Rishidas	63	SC	No	M	038846823681	9932465785	S.B.I	Taki	88267102743	









Sl No.	Ward No	Slum/Non Slum	Name of the Beneficiary	Father's/Husband's Name	Holding No. / Address	Category		Minority	Gender	Adhar No.	Mob No.	Bank Name	Branch	Bank Ac. No	Photo
						GENERAL/S.C/S.T./OBC									
17	8	Slum	Debasish Das	Lt. Jiban Das	4174/250	Gen	No	M	219028318815	9932465785	Allahabad Bank	Taki	59139097269		
18	8	Slum	Barun Kumar Rishidas	Lt. Panchu Rishidas	481	SC	No	M	825561955637	8293674749	S.B.I	Taki	32438593891		
19	8	Slum	Rupi Rishidas	Lt. Lakshman Rishidas	88/188	SC	No	F	220582469409	7318636779	Allahabad Bank	Taki	21375593825		
20	8	Slum	Ranjit Rishidas	Panchuram rishidas	520/4266	SC	No	M	414901737032	9933485603	S.B.I	Taki	33182168030		
21	8	Slum	Chinta Pal	Lt. Asutosh Pal	460	OBC	No	F	470461025327	9874536276	Allahabad Bank	Taki	21375593417		
22	8	Slum	Siddhartha Biswas	Lt. Partha Biswas	884	OBC	No	M	48154489111	9064141920	Allahabad Bank	Taki	50343448359		
23	8	Slum	Sanjit Majumdar	Subol Majumdar	153	Gen	No	M	719756129872	9748153434	U.B.I	Hasnabad	0 144010233798		
24	8	Slum	Ananda Rishidas	Lt. Putram Rishidas	504	SC	No	M	508375821874	7430931798	Allahabad Bank	Taki	59037693143		









Sl No.	Ward No	Slum/Non Slum	Name of the Beneficiary	Father's/ Husband's Name	Holding No. / Address	Category		Minority	Gender	Adhar No.	Mob No.	Bank Name	Branch	Bank Ac. No	Photo
						General/S.C/S.T./OBC									
25	8	Slum	Rina Biswas	Ramani Biswas	395	SC	No	F	782706785345	9932465785	U.B.I	Hasnabad	0 144010115031		
26	8	Slum	Namita Dhali	Bishnupada Dhali	682	SC	No	F	586535327930	7679991218	Allahabad Bank	Taki	50098380734		
27	8	Slum	Subhas Dhali	Lt. Harendranath Dhali		SC	No	M	608536719249	8167433254	Allahabad Bank	Kumarpukur	22258612745		
28	8	Slum	Dipa Biswas	Lt. Kumud ranjan Biswas	113	Gen	No	F	295734896900	9732707765	Allahabad Bank	Taki	50372929923		
29	8	Slum	Somenath Sarkar	Kalidas Sarkar	82	Gen	No	M	619139065358	9332689338	Allahabad Bank	Taki	59005028978		
30	8	Slum	Ranjit Rishidas	Lt. Sudhir Rishidas	18	SC	No	M	419686513629	9609063743	S.B.I	Taki	34875795566		
31	8	Slum	Prabir Biswas	Pulin Biswas	60	OBC	No	M	687235120587	9932833394	Allahabad Bank	Taki	59113641600		
32	8	Slum	ujjal pal	KANAILAL PAL	73	OBC	No	M	733947951884	9832438703	Allahabad Bank	Taki	50098679736		









Chairman  
Taki Municipality

Sl No.	Ward No	Slum/Non Slum	Name of the Beneficiary	Father's/ Husband's Name	Holding No. / Address	Category		Gender	Adhar No.	Mob No.	Bank Name	Branch	Bank Ac. No	Photo
						GENERAL/S.C/S.T./OBC	Minority							
33	8	Slum	DIPAK PAUL	LATE KRISHNA PADA PAUL	172	OBC	No	M	621632958296	9932865785	Allahabad Bank	Taki	59068429478	









  
Chairman  
Taki Municipality









Sl No.	Ward No	Slum/Non Slum	Name of the Beneficiary	Father's/ Husband's Name	Holding No. / Address	Category		Gender	Adhar No.	Mob No.	Bank Name	Branch	Bank Ac. No	Photo
						GENERAL/S.C/S.T./OBC	Minority							
1	9	Slum	Kakali Das	Gobinda Das	919	Gen	No	F	412944563771	9635811696	Allahabad Bank	Taki	21375559001	
2	9	Slum	Amal Kumar Kundu	Lt. Netal Kundu	230	Gen	No	M	399522898365	9563912089	Allahabad Bank	Taki	50266279022	
3	9	Slum	Ranjit Das	Lt. Balai Ch. Das	248	Gen	No	M	988337348703	7679868667	Allahabad Bank	Taki	59060876376	
4	9	Slum	Chittaranjan Pal	Lt. Harendranath Pai		Gen	No	M	747931357635	9932955530	Allahabad Bank	Taki	59060562745	
5	9	Slum	Sambhunath Kundu	Lt. Netal Kundu	230	Gen	No	M	752143840558	8101548119	S.B.I	Taki	30088311160	
6	9	Slum	Goutam Pal	Lt. Paramananda Pal	237	Gen	No	M	589361360631	9547380891	S.B.I	Taki	35256989455	
7	9	Slum	Ananta Chakraborty	Lt. kartick Chakraborty		Gen	No	M	787736539703	9932027068	Allahabad Bank	Taki	50354685251	
8	9	Slum	Madhabi Pal	Swapan pal		Gen	No	F	719957737776	9126119260	Allahabad Bank	Taki	5008252579	









Sl No.	Ward No	Slum/Non Slum	Name of the Beneficiary	Father's/ Husband's Name	Holding No. / Address	Category		Minority	Gender	Adhar No.	Mob No.	Bank Name	Branch	Bank Ac. No	Photo
						GENERAL/S.C/S.T./OBC	Gen								
9	9	Slum	Aparna Das	Basudeb Das		Gen	No	F	620639724848	9002543140	Allahabad Bank	Taki	21375593927		
10	9	Slum	Ramu Das	Arun Das		Gen	No	M	438894301775	7319527992	Allahabad Bank	Taki	21375560163		
11	9	Slum	Rajesh Das	Kaildas Das	505	Gen	No	M	863082035225	9800913006	S.B.I	Taki	33586900588		
12	9	Slum	Goutam Rishidas	Lt. Khitish Rishidas	436	SC	No	M	722503094964	7908752882	Allahabad Bank	Taki	59134892922		
13	9	Slum	Nemal Rishidas	Lt. Tarak Rishidas		SC	No	M	900593580588	9593763057	Allahabad Bank	Taki	50346818205		
14	9	Slum	Saraswati Rishidas	Lt. Dukhiram Rishidas		SC	No	F	481740907541	7029176595	Allahabad Bank	Taki	59151427136		
15	9	Slum	Arun Das	Lt. Debiprasad Das	139	Gen	No	M	794395813712	9635409325	Allahabad Bank	Taki	59056500137		
16	9	Slum	Rabin Biswas	Lt. Netral Ch. Biswas		Gen	No	M	643260063361	8145111003	Allahabad Bank	Taki	99345409203		









Sl No.	Ward No	Slum/Non Slum	Name of the Beneficiary	Father's/ Husband's Name	Holding No. / Address	Category		Gender	Adhar No.	Mob No.	Bank Name	Branch	Bank Ac. No	Photo
						GENERAL/S.C/S.T./OBC	Minority							
17	9	Slum	Jhantu Das	Sunil Das		Gen	No	M	499859794040	9002977800	Allahabad Bank	Taki	59099310942	
18	9	Slum	Basudeb Rishidas	Lt. Shanti Rishidas		SC	No	M	775099080373	6290972366	Allahabad Bank	Taki	59151427746	
19	9	Slum	Prasanta Nath	Sudhir Nath	1120	Gen	No	M	894110752127	7074008315	Allahabad Bank	Taki	50109700600	
20	9	Slum	Tapan Rishidas	Lt. Kamal Rishidas	868	SC	No	M	297637040921	8509948640	Allahabad Bank	Taki	59070144089	
21	9	Slum	Bhupal Rishidas	Partosh Rishidas	1109	SC	No	M	438824897989	9735713801	Allahabad Bank	Taki	22258637022	
22	9	Slum	Khudiram Das	Lt. Shatrughna Das		Gen	No	M	503682698309	8101236070	Allahabad Bank	Taki	21375557635	
23	9	Slum	Kalidas Rishidas	Lt. Kena Rishidas		SC	No	F	893102697963	7699882134	Allahabad Bank	Taki	21375547904	
24	9	Slum	Dipu Mistri	Bakul Mistri	1025	Gen	No	M	614244828445	8972527022	BOI	Taki	41101010001694	



















Sl No.	Ward No	Slum/Non Slum	Name of the Beneficiary	Father's/ Husband's Name	Holding No. / Address	Category		Gender	Adhar No.	Mob No.	Bank Name	Branch	Bank Ac. No	Photo
						GENERAL/S.C/S.T./OBC	Minority							
25	9	Slum	Blkash Das	Rangalal Das	866	Gen	No	M	467127936811	7501650469	Allahabad Bank	Taki	59071298868	
26	9	Slum	Ujjwal Guha Sarkar	Tripti Guha Sarkar		Gen	No	M	700087508502	9932742046	Allahabad Bank	Taki	21375571222	
27	9	Slum	Aloke Chatterjee	Gopal Chatterjee	296	Gen	No	F	847112848328	9732463217	Allahabad Bank	Taki	59170327398	
28	9	Slum	Bina Das	Lt. Hazari Das		Gen	No	F	791340155292	9679650814	Allahabad Bank	Taki	50098686718	
29	9	Slum	Sudeb Rishidas	Bhim Chandra Rishidas		SC	No	M	874011460902	8016611312	S.B.I	Taki	20034395783	
30	9	Slum	Krishna Pal	Aloke Pal		Gen	No	F	719529196123	8145371953	S.B.I	Taki	36539286956	
31	9	SLUM	KABITA MONDAL	BHOLANATH MONDAL	875	SC	No	F	845096373307	8641058444	Allahabad Bank	Taki	59055254171	
32	9	S	SHIBUPADA NATH	LATE NITAI NATH	168	GEN	No	M	932803931997		Allahabad Bank	Taki	24375583839	







Sl No.	Ward No	Slum/Non Slum	Name of the Beneficiary	Father's/ Husband's Name	Holding No. / Address	Category		Minority	Gender	Adhar No.	Mob No.	Bank Name	Branch	Bank Ac. No	Photo
						General/S.C/S.T./OBC	GEN								
33	9	Non-Slum	Kaipana Das	Narayan Das		Gen	No	F	722702867028			BGVB	Hasnabad	5217010001086	
34	9	Non-Slum	SAMPA DAS	BABU KUMAR DAS		GEN	No	F	466340197298			Allahabad	Taki	59170217422	
35	9	Non-Slum	GOUR BISWAS	DHANANJOY BISWAS		GEN	No	M	415416963444			Allahabad	Taki	59148389783	
36	9	Non-Slum	BUAY PRODHAN	MADAN PRADHAN		GEN	No	M	826501488527			Allahabad	Taki	21375578240	
37	9	Non-Slum	TAPAS HALDER	LATE ANANDA HALDER		GEN	No	M	449066535174			SBI	Taki	37831982862	
38	9	Non-Slum	ANJALI RISHIDAS	MURARI RISHI DAS		SC	No	F	967687651458			Allahabad	Taki	50360207526	
39	9	Non-Slum	ALOKA DAS	BASUDEB DAS		GEN	No	F				UBI	Hasnabad	0144010133920	
40	9	Non-Slum	BASANTI DAS	BUDDADEB DAS		GEN	No	F				Allahabad Bank	Taki	30099190929	

Sl No.	Ward No	Slum/Non Slum	Name of the Beneficiary	Father's/ Husband's Name	Holding No. / Address	Category		Gender	Adhar No.	Mob No.	Bank Name	Branch	Bank Ac. No	Photo
						General/S.C/S.T./OBC	Minority							
1	10	Martin Barn Road	Arun Ghosh	Asutosh Ghosh	338	OBC	No	M	438864566089	8293177198	U. B. I	Hasnabad	0144010111001	
2	10	Rajipur	Balaram Sen	Manimohan Sen	533	GEN	No	M	537529832680	9614267663	S. B. I	Taki	34547256517	
3	10	Dhopa Para	Moksed Ali Gazi	Johar Ali Gazi	302	GEN	YES	M	687445233187	8653514491	S. B. I	Taki	32030496118	
4	10	Rajipur Das Para	Rabindranath Das	Lalbihari Das	441	GEN	NO	M	413480614560	8967032211	Allahabad	Taki	21375539233	
5	10	Rajak Para	Biswajit Das	Dulal Chandra Das	87	OBC	NO	M	567111780426	8101985166	S. B. I	Taki	30439999017	
6	10	Chowrangee	Baishaki Ghosh	Rabindra Nath Ghosh	533	OBC	NO	F	888999641375	9614267663	Allahabad	Taki	50419704400	
7	10	Dhopa Para	Uday Rajak	Totan Rajak	81	GEN	NO	M	933314032174	8145016752	S. B. I	Taki	33403717233	
8	10	Rajipur idgah Para	Anarul Gazi	Abdul Jalil Gazi	93	OBC	YES	M	345182396066	9547157376	Allahabad	K. P.	50434748439	









Sl No.	Ward No	Slum/Non Slum	Name of the Beneficiary	Father's/ Husband's Name	Holding No. / Address	Category		Minority	Gender	Adhar No.	Mob No.	Bank Name	Branch	Bank Ac. No	Photo
						GENERAL/S.C/S.T./OBC									
9	10	Rajipur	Md.Abusalam Gazi	Md. Anarali Gazi	84	OBC		YES	M	321466758958	9647788857	S. B. I	Taki	10608726198	
10	10	Rajipur Kolu Para	Abdul Rasid Mondal	Lt. Sariyat Mondal	285	OBC		YES	M	959940455209	7584966777	Allahabad	K. P.	50333314417	
11	10	Rajipur Kolu Para	Arshad Ali Mondal	Niyamat Ali Mondal	160	Gen		YES	M	413763048692	9083792431	U. B. I	Hasnabad	0144010221634	
12	10	Binod Colony	Sunil Roy	Benoy Roy	314	GEN		No	M	897874232528	9732621819	U. B. I	Hasnabad	0144010113368	
13	10	Ghosh Para	Subhabrata Ghosh	Narayan Ch. Ghosh	365	OBC		No	M	432447250927	9775220975	S. B. I	Taki	33567419807	
14	10	Taki Road	Chandra Basu	Pulak	145	GEN		No	F	775363629681	7602910701	Allahabad	Taki	50159134577	
15	10	Rajipur	Anoyara Gazi	Soukat Gazi	209	Gen		YES	F	386041635474	7897523543	U. B. I	Hasnabad	0144010283343	
16	10	Idgah Para	Taumina Gazi	Abul Basar Gazi	667	Gen		YES	F	372934516405	8534419364	Allahabad	K. P.	59139897131	

Sl No.	Ward No	Slum/Non Slum	Name of the Beneficiary	Father's/ Husband's Name	Holding No. / Address	Category		Minority	Gender	Adhar No.	Mob No.	Bank Name	Branch	Bank Ac. No	Photo
						General/S.C/S.T./OBC	GEN								
17	10	Rajipur	Jahar Hossain Mondal	Didar Box Mondal	62	OBC	YES	M	851484142180	7864868098	Allahabad	Taki	59153913316		
18	10	Kolu Para	Nazma Bibi	Afchar Gazi	82	Gen	YES	F	944028443985	7557026418	U. B. I	Hashnabad	0144010582865		
19	10	Rajipur	Iman Ali Gazi	Akkaj Gazi	90	OBC	YES	M	304788598331	9091335572	S. B. I	Taki	35655796838		
20	10	Rajipur	Nari Bibi	Sukchand Gazi	399	Gen	YES	F	943467226103	9933626190	Allahabad	K. P.	22258637747		
21	10	Rajipur	Asmaul Husna	Rafikul Islam Mallick	103	Gen	YES	F	456618312796	9732521741	Allahabad	Taki	59169860116		
22	10	Rajipur Das Para	Kenaram Mistri	Ratikanta Mistri	194	OBC	YES	M	821899506740	9936525241	U. B. I	Hashnabad	0144010227117		
23	10	Kolu Para	Roup Ali Gazi	Deen Ali Gazi	207	OBC	YES	M	847438081450	8373817893	Allahabad	Taki	59161924067		
24	10	Rajipur	Chaira Bibi	Hossain Sardar	511	OBC	YES	F	548783241481	7865213940	S. B. I	Taki	36714215091		









Sl No.	Ward No	Slum/Non Slum	Name of the Beneficiary	Father's/ Husband's Name	Holding No. / Address	Category		Minority	Gender	Adhar No.	Mob No.	Bank Name	Branch	Bank Ac. No	Photo
						GENeral/S.C/S.T./OBC									
25	10	Kolu Para	Meherunnesha Bibi	Abul Kaseem Mondal	603	OBC	YES	F	511039397599	9933732160	Allahabad	K. P.	511039397599		
26	10	Kolu Para	Iunus Sardar	Fajar Sardar	710	OBC	YES	M	603560442108	8927785394	S. B. I	Taki	30863403925		
27	10	Rajipur	Jagannath Mondal	Annada Mondal	49	SC	No	M	446301938995	9732621819	S. B. I	Taki	36297323083		
28	10	Rajipur	Hafizul Gazi	Majibar Gazi	560	OBC	YES	M	211020577252	9733486278	Allahabad	Taki	50452001847		
29	10	Rajipur	Prasenjit Das	Ramesh Das	542	GEN	NO	M	707958735607	9733486278	U. B. I	Hasnabad	0144010407991		
30	10	Martin Barn Road	Swapan Bhattacharya	Bholanath Bhattacharya	123	GEN	NO	M	958794961942	9932526525	Allahabad	K. P.	22258531445		
31	10	Hasnabad Das Par	Jahanara Alam	A K M Tarikul Alam	720	OBC	YES	F	397486593692	9733486278	U. B. I	Hasnabad	0144010352420		
32	10	Rajipur Martin Road	Dinesh Chandra Mondal	Sachindra Nath Mondal	316	SC	NO	M	473951269874	7864888042	U. B. I	Hasnabad	0144010109871		









Sl No.	Ward No	Slum/Non Slum	Name of the Beneficiary	Father's/ Husband's Name	Holding No. / Address	Category		Minority	Gender	Adhar No.	Mob No.	Bank Name	Branch	Bank Ac. No	Photo
						GENeral/S.C/S.T./OBC	Gen								
33	10	Rajipur	Sabita Sharma	Dharmendra Sharma		Gen	NO	F	624280973878			S. B. I	Taki	32076354943	
34	10	Rajipur	Pijush Paik	subol Paik	142	Gen	NO	M	243551807614			Allahabad	Taki	59060688689	
35	10	Rajipur	Tayebur Rahaman Gazi	Abdul Kader Gazi		Gen	YES	M	721845358656			Allahabad	K. P.	50040114510	
36	10	Rajipur	Sirajul Gazi	Nur Moslem Gazi		Gen	YES	M	859911899596			Uco Bank	Basirhat	06750110041994	
37	10	Rajipur	Rejia Begam	Azizul Islam Gazi		Gen	YES	F	618659185914			S. B. I	Taki	20033330168	
38	10	Non-Slum	Aju Mondal	Maula Box Mondal		Gen	YES	M	379411458830			UBI	Hasnabad	0 144010239240	
39	10	SLUM	RANJIT MONDAL	SARAT MONDAL	272	SC	No	M	568597439697			SBI	Taki	34710894431	

  
Chairman  
TAKI MUNICIPALITY









Sl No.	Ward No	Slum/Non Slum	Name of the Beneficiary	Father's/ Husband's Name	Holding No. / Address	Category		Gender	Adhar No.	Mob No.	Bank Name	Branch	Bank Ac. No	Photo
						GENERA/ S.C/S.T./OBC	Minority							
1	11	Jugia	Niranjan Majumder	Lt. Gangadhar Majumder	217	Gen	NO	M	765954972970	9614490911	Allahabad	Taki	59166485159	
2	11	Ramakrishna Palli	Dipali Mondal	Jogeswar Mondal	706	sc	NO	F	851984921205	9647475162	SBI	Taki	35000396401	
3	11	Jugia	Rammohan Rishidas	Haricharan Rishidas	152	sc	NO	M	812202797645	7548933360	UBI	Hasnabad	0144010520997	
4	11	Jugia	krishna Rishidas	Lt.Satish Rishidas	51	sc	NO	M	587564916652	7699430589	Allahabad	Taki	59093602501	
5	11	Jugia	Hari Rishidas	Lt. Radhapada rishidas	150	sc	NO	M	320633519806	7384001458	Allahabad	Taki	59135922572	
6	11	Jugia	Gurucharan Rishidas	Lt. Radhapada rishidas	150	sc	NO	M	722485279110	8942939837	UBI	Hasnabad	0144010222297	
7	11	Jugia	Anima adhikari	Lt. santkar Adhikari	549	Gen	NO	F	548757546227	8770348499	SBI	Taki	34808091091	
8	11	Jugia	Kamal Mondal	Lt. Tarapada Mondal	447	sc	NO	M	477710287904	8479964332	Allahabad	Taki	59166480230	













Sl No.	Ward No	Slum/Non Slum	Name of the Beneficiary	Father's/ Husband's Name	Holding No. / Address	Category		Gender	Adhar No.	Mob No.	Bank Name	Branch	Bank Ac. No	Photo
						General/s.C/S.T./OBC	Minority							
1	6	AGRADANIPARA	SUDHA BISWAS	W/O- DHRUBA BISWAS	HOLDING-295 TAKI AGRADANIPARA, TAKI N 24 PGS. PIN-743429	SC	NO	F	225810955291	7384193349	ALLAHABAD BANK	TAKI	5014686792-9	
2	6	TAKI DAKSHINRARI PARA	FORIJA BIBI	W/O-KALAM GAZI	TAKI DAKSHINRARI PARA TAKI, N 24 PGS., 743429 HOLDING NO.-431	GEN	YES	F	87450689449	8535992273	ALLAHABAD BANK	TAKI	59098873600	
3	6	TAKI DAKSHINRARI PARA	RATAN MONDAL	Late TARAPADA MONDAL	TAKI DAKSHINRARI PARA; TAKI, NORTH 24 PARGANAS	SC	NO	M	272815789118	9635460447	ALLAHABAD BANK	TAKI	5009273427-1	
4	6	THUBA MOTIJHIL	MUKUNDA GHOSH	Late BIRENDEA NATH GHOSH	THUBA MOTIJHIL, TAKI, HASNABAD, NORTH 24 PGS.HOLDING-	GEN	NO	M	756949935643	9732450612	ALLAHABAD BANK	TAKI	50405576431	
5	6	TAKI AGRADANI PARA TAKI	SHYAMALI DAS	W/O-BADAL DAS	TAKI AGRADANI PARA TAKI, N 24 PGS., PIN-743429	SC	NO	F	953242904239	9733668587	ALLAHABAD BANK	TAKI	59106503225	
6	6	RAJIPUR DAS PARA HASNABA	KALIPADA BISWAS	LATE LALIT BISWAS	RAJIPUR DAS PARA HASNABA, N 24 PGS., 743426 HOLDING-499	OBC	NO	M	628023287550	9332334683	UBI, HASNABAD	HASNABAD	144010104319	
7	6	THUBA MOTIJHIL TAKI	KOUSAR KHALIFA	MD ISMAIL KHALIFA	THUBA MOTIJHIL, TAKI, N 24 PGS. HOLDING-884	GEN	YES	M	899219972031	9635344189	ALLAHABAD BANK	TAKI	21375579866	
8	6	RAJIPUR DAS PARA HASNABA	GOURIBALA BISWAS	W/O-DULAL CH. BISWAS	RAJIPUR DAS PARA HASNABA, N 24 PGS., 743426 HOLDING-477	OBC	NO	F	407761518300	7063046514	ALLAHABAD BANK	TAKI	59099860497	

Sl No.	Ward No	Slum/Non Slum	Name of the Beneficiary	Father's/ Husband's Name	Holding No. / Address	Category		Gender	Adhar No.	Mob No.	Bank Name	Branch	Bank Ac. No	Photo
						General/S.C/S.T./OBC	Minority							
9	6	RAJIPUR DAS PARA HASNABAD	SUDHANGSU BISWAS	GOBINDA BISWAS	RAJIPUR DAS PARA HASNABAD, N 24 PGS, 743426 HOLDING NO- 1669/441	OBC	NO	M	599210935169	9614298054	9800955566	TAKI	5015887117-0	
10	6	TAKI AGRADANI PARA TAKI	KAKALI BISWAS	D/O- LATE SMARAJIT BISWAS	TAKI AGRADANI PARA TAKI, N 24 PGS, PIN- 743429	OBC	NO	F	605283536771	8420068685	ALLAHABAD BANK	TAKI	20572230727	
11	6	TAKI AGRADANI PARA TAKI	BHAKTA MONDAL	RAMPADA MONDAL	HOLDING NO- 777 TAKI, N 24 PARGANAS	SC	NO	M	318924216507	7679227192	ALLAHABAD BANK	TAKI	5009821964-1	
12	6	TAKI PURATAN BAZAR	SUMANGAL DEBNATH	MANIK DEBNATH	TAKI PURATAN BAZAR TAKI, N 24 PARGANAS	OBC	NO	M	559998656713	7063032023	ALLAHABAD BANK	TAKI	59055252027	
13	6	TAKI KALIBARI PARA	SUJATA PAL	W/O- MAHENDRA PAL	TAKI KALIBARI PARA	GEN	NO	F	298881429733	8016511466	ALLAHABAD BANK	TAKI	21375579389	
14	6	RAJIPUR DALAL PARA	SUPARNA ROY	D/O- NILKAMAL ROY	RAJIPUR DALAL PARA	OBC	NO	F	814796872381	8617562692	UNITED BANK OF INDIA	HASNABAD	144010117830	
15	6	RAJIPUR DALAL PARA	JADHUNATH DAS	LATE BHUDHAR DAS	HOLDING No- 516	GEN	NO	M	616500929418	8350071393	DO	HASNABAD	144010109142	
16	6	TAKI KALIBARI PARA	DAYAL CHANDRA BISWAS	LATE SUKLAL BISWAS	TAKI KALIBARI PARA HOLDING-399	GEN	NO	M	694614690765	7679495909	HARIPUR S K U S LTD.	BASIRHAT IFSC-UTIB0CCCH274	208620130008477	









Chairman  
Taki Municipality









Sl No.	Ward No	Slum/Non Slum	Name of the Beneficiary	Father's/ Husband's Name	Holding No. / Address	Category		Gender	Adhar No.	Mob No.	Bank Name	Branch	Bank Ac. No	Photo
						GENERAL/S.C/S.T./OBC	Minority							
17	6	RAJIPUR CHAR PARA HASNABAD	PULAK BISWAS	LATE TRIPURARI BISWAS	RAJIPUR CHAR PARA HASNABAD, N 24 PGS.	GEN	NO	M	686611096839	7384662884	ALLAHABAD BANK	TAKI	59058730067	
18	6	RAJIPUR CHAR PARA	PRA TAP BISWAS	LATE KISHORI MOHAN BISWAS	RAJIPUR CHAR PARA Holdings-475	GEN	NO	M	891825012340	9733901097	ALLAHABAD BANK	TAKI	31845769735	
19	6	RAJIPUR CHAR PARA	BISWAJIT DAS	LATE BIREN DAS	RAJIPUR CHAR PARA	GEN	NO	M	505104493496	7477546272	AXIS BANK	HASNABAD	59170274388	
20	6	RAJIPUR CHAR PARA	SUKUMAR DAS	LATE SASADHAR DAS	HOLDING NO 482	GEN	NO	M	991099679533	8001877800	ALLAHABAD BANK	TAKI	5004069470-3	
21	6	RAJIPUR CHAR PARA	MOHANTA DAS	LATE GOUR CHANDRA DAS	HOLDING-452	GEN	NO	M	682783387613	9564171929	ALLAHABAD BANK	TAKI	21375596815	
22	6	THUBA MOTIZHIL	MD REZAUL MONDAL	HATEM MONDAL	THUBA MOTIZHIL, TAKI, NORTH 24 PGS., PIN-743429	GEN	YES	F	214907319923`	7679981123	BANK OF INDIA	TAKI	415810110000444	
23	6	TAKI DAKSHIRARI PARA	SISIR MAJUMDER	LATE AMULYA MAJUMDER	TAKI DAKSHIRARI PARA, TAKI, N 24 PGS. HOLDING NO.. 274	GEN	NO	M	517741347736	6297696516	BANK OF INDIA	TAKI	4158101100001922	
24	6	TAKI DAKSHIRARI PARA	SIMA GHOSH	LATE BINDY RANJAN GHOSH	TAKI DAKSHIRARI PARA TAKI, NORTH 24 PGS.,	GEN	NO	F	986295655566	9775988658	ALLAHABAD BANK	TAKI	5008479147-8	









Sl No.	Ward No	Slum/Non Slum	Name of the Beneficiary	Father's/ Husband's Name	Holding No. / Address	Category		Gender	Adhar No.	Mob No.	Bank Name	Branch	Bank Ac. No	Photo
						GENERA./S.C/S.T./OBC	Minority							
25	6	DAKSHIRARI PARA	RASID GAZI	LATE BATUL GAZI	HOLDING NO.-264 DAKSHIRARI PARA TAKI, N 24 PGS.	GEN	YES	M	791175534320	8967679169	ALLAHABAD BANK	TAKI	9813	
26	6	TAKI AGRADANI PARA	GAUTAM MONDAL	LATE KINURAM MONDAL	TAKI AGRADANI PARA HOLDING NO.-286 TAKI, NORTH	SC	NO	M	211390488330	9564553058	ALLAHABAD BANK	TAKI	50182613937	
27	6	TAKI AGRADANI PARA	SIBNATH MONDAL	LATE SUNIL MONDAL	HOLDING-287 TAKI AGRADANI PARA TAKI, N 24	SC	NO	M	207666180602	8145111103	ALLAHABAD BANK	TAKI	59037693030	
28	6	DALALPARA	ANJUARA BIBI	MD AJIFAR RAHAMAN GAZI	DALALPARA, T AK(M) HASNABAD, N 24 PGS. PIN743426	GEN	YES	F	354859468259	7001994562	STATE BANK OFINDIA	TAKI	35268350927	
29	6	KALIBARI PARA	SANTOSH MONDAL	LATE PANCHANAN MONDAL	HOLDING-684 TAKI KALIBARI PARA TAKI, N 24	SC	NO	M	926203982417	8972579828	BANK OF INDIA	TAKI	415810110000119	
30	6	MATUJIL	MANU MONDAL	W/O- NIUR MOHAMMAD MONDAL	MATUJIL, TAKI NORTH 24 PGS.	GEN	YES	F	676779010404	9093929186	ALLAHABAD BANK	TAKI	21375592844	
31	6	TAKI DAKSHINRARI PARA	SWAPAN MONDAL	Late TARAPADA MONDAL	TAKI DAKSHINRARI PARA TAKI, NORTH 24 PGS., HOLDING NO.-534	SC	NO	M	754759200706	9332147890	ALLAHABAD BANK	TAKI	5009081504-0	
32	6	TAKI DAKSHINRARI	BISWANATH MONDAL	SANTOSH MONDAL	TAKI DAKSHINRARI PARA TAKI, N 24 PGS., 743429	SC	NO	M	878010789495	9088056743	ALLAHABAD BANK	TAKI	50223482091	

Sl No.	Ward No	Slum/Non Slum	Name of the Beneficiary	Father's/ Husband's Name	Holding No. / Address	Category		Gender	Adhar No.	Mob No.	Bank Name	Branch	Bank Ac. No	Photo
						GENERAL/S.C/S.T./OBC	Minority							
33	6	Non- Slum	Sabita Mondal	Ratan Mondal	507	SC	NO	F	944364815056	8101362165	Allahabad	Kumarpukur	21375561791	
34	6	Non- Slum	Robin Biswas	Ranajit Biswas		Gen	NO	M	354425145068	933624434	UBI	Hasnabad	0 144010114330	









  
 Chairman  
 Taki Municipality









Sl No.	Ward No	Slum/Non Slum	Name of the Beneficiary	Father's/ Husband's Name	Holding No. / Address	Category		Gender	Adhar No.	Mob No.	Bank Name	Branch	Bank Ac. No	Photo
						GENERAL/S.C/S.T./OBC	Minority							
1	7	Non Slum	Amar Mondal	Gopal Mondal	105	SC	No	M	671168159195	9547699221	Allahabad Bank	Taki	21375572838	
2	7	Non Slum	Dipak Das	Amulya Das	134	Gen	No	M	514554925816	9609212679	Allahabad Bank	Taki	59055170380	
3	7	Non Slum	Nitu Mondal	Anukul Mondal	685	SC	No	M	655845191074	7908285646	Allahabad Bank	Taki	50191353476	
4	7	Non Slum	Tirchanakar Das	LATE Dinesh Chandra Das	583	Gen	No	M	586782587393	9827458996	S.B.I	Taki	32039347373	
5	7	Non Slum	Lina Issu Hazra	Haridas Issu	604	SC	No	F	525727061553	7318779346	Allahabad Bank	Taki	50433728898	
6	7	Non Slum	Mirinal Kantti Das	Kartick Das		Gen	No	M	861337251384	6297534069	Allahabad Bank	Taki	21375568527	
7	7	Non Slum	Subir Mondal	Nidhu Mondal	694	SC	No	M	7602186899	#####	Allahabad Bank	Taki	50323042089	
8	7	Non Slum	Subir Das	Lt. Shyamanath Das	113	Gen	No	M	2459985120	9641204726	Allahabad Bank	Taki	50217671461	

Sl No.	Ward No	Slum/Non Slum	Name of the Beneficiary	Father's/ Husband's Name	Holding No. / Address	Category		Gender	Adhar No.	Mob No.	Bank Name	Branch	Bank Ac. No	Photo
						GENERAL/S.C/S.T./OBC	Minority							
9	7	Non Slum	Mohan Mondal	Lt. Gopal Mondal	711	SC	No	M	323070094152	8768409110	Allahabad Bank	Taki	50477501897	
10	7	Non Slum	Bikash Pal	Nripendra Pal	885	Gen	No	M	805872306598	9339556514	Allahabad Bank	Taki	21375566835	
11	7	Non Slum	Lakshmi Rani Mondal	Lt. Hazarilal Mondal		SC	No	F	552626733435	9564484506	S.B.I	Taki	36212036917	
12	7	Non Slum	Prasenjit Mondal	Pradip Mondal		SC	No	M	485297201778	9614116834	Allahabad Bank	Taki	56315493369	
13	7	Non Slum	Sukanta Mondal	Haran Mondal		SC	No	M	474002423921	8167433254	S.B.I	Taki	20002358997	
14	7	Non Slum	Bholanath Rishidas	Kenaram Rishidas	299	SC	No	M	891204082546	8609440537	U.B.I	Hasnabad	0 144010353946	
15	7	Non Slum	Minu Rishidas	Lt. Anath Rishidas	952	SC	No	F	685114717433	6295409247	Allahabad Bank	Taki	50182898332	
16	7	Non Slum	Biswajit Rishidas	Dulal Rishidas	892	SC	No	M	910340429051	9635072036	Allahabad Bank	Taki	59099860533	









Sl No.	Ward No	Slum/Non Slum	Name of the Beneficiary	Father's/Husband's Name	Holding No. / Address	Category		Gender	Adhar No.	Mob No.	Bank Name	Branch	Bank Ac. No	Photo
						GENERAL/S.C/S.T./OBC	Minority							
17	7	Non Slum	Ramkrishna Podder	Lt. Sudhir Kumar Podder	569	Gen	No	M	394683104579	8016326455	Allahabad Bank	Taki	50062008799	
18	7	Non Slum	Anguri Rishidas	Lt. Nagendra Rishidas	689	SC	No	F	233387575198	8250525742	Allahabad Bank	Taki	21375594705	
19	7	Non Slum	Debdas Rishidas	Monoranjan Rishidas	928	SC	No	M	891056992870	8768003182	Allahabad Bank	Taki	59055252210	
20	7	Non Slum	Krishnapada Mondal	Jharu Mondal	818	SC	No	M	921973650614	7872058243	S.B.I	Taki	31025717441	
21	7	Non Slum	Arati Roy Khan	Biswanath Roy Khan	855	Gen	No	F	828075540417	9775227208	Allahabad Bank	Taki	21375596962	
22	7	Non Slum	Pranab Dutta	Panchuram Dutta	271	OBC	No	M	936592707518	6297534252	Allahabad Bank	Taki	50266832900	
23	7	Non Slum	Gouri Adhikary	Lt. Amal Adhikary	580	Gen	No	F	326528542510	9002100574	Allahabad Bank	Taki	59053770313	
24	7	Non Slum	Dulal Das	Lt. Asit Kumar Das		Gen	No	M	91805901724	8369727028	Allahabad Bank	Taki	50299780020	



















Sl No.	Ward No	Slum/Non Slum	Name of the Beneficiary	Father's/ Husband's Name	Holding No. / Address	Category		Gender	Adhar No.	Mob No.	Bank Name	Branch	Bank Ac No	Photo
						General/S.C/S.T./OBC	Minority							
17	3	UTTARPALLY	LATIKA BISWAS	SARSA BISWAS		GEN	NO	F	39949080318	9533071530	ALLA HABAD	TAKI	21375553860	
18	3	JORA MANDIR	MAIJOKA BISWAS	KHATRA MOHAN BISWAS	399	GEN	NO	F	492151727687	9517233241	ALLA HABAD	TAKI	21375541265	
19	3	DAS PARA	MAIHUSADAN BISWAS	HARACHAN BISWAS	27	OBC	NO	M	66858676122	9679277543	ALLA HABAD	TAKI	50213063919	
20	3	UTTARPALLY	BABULAL DAS	SANTI DAS	589	GEN	NO	M	529867991858	9933572649	ALLA HABAD	TAKI	21375557821	
21	3	DEBU BABUR BAGAN	AKBAR GAZI	AJIBAR GAZI	414	GEN	YES	M	871648486403	8031751919	ALLA HABAD	TAKI	50452032377	
22	3	DEBU BABUR BAGAN	AYUB GAZI	MAJIT GAZI		GEN	YES	M	308740762188	9517339620	ALLA HABAD	TAKI	50288203387	
23	3	UTTARPALLY	TRIFTI DAS	UPENDRO DAS	140	GEN	NO	F	968289046378	8670851515	ALLA HABAD	TAKI	50219581367	
24	3	UTTARPALLY	RAMEN BISWAS	BHAMISAL BISWAS	247	OBC	NO	M	638014194916	8317373022	ALLA HABAD	TAKI	21375583408	









Sl No.	Ward No	Slum/Non Slum	Name of the Beneficiary	Father's/ Husband's Name	Holding No. / Address	Category		Gender	Adhar No.	Mob No.	Bank Name	Branch	Bank Ac No	Photo
						GENERAL/S.C/S.T./OBC	Minority							
25	3	UTTARPALLY	SUKJMAR DAS	RATHINDRA NATH DAS		GEN	NO	M	434235526366	8936478593	ALLA HABAD	TAKI	50116703466	
26	3	DAS PARA	SANJTI MONDAL	SANKAR MONDAL		SC	NO	M	297410040042	7334167758	ALLA HABAD	TAKI	50222343218	
27	3	JORA MANDIR	RABIN KARVIKAR	KANAI KARMAKAR	81	GEN	NO	M	230026511299	9874656524	ALLA HABAD	TAKI	59170263689	
28	3	DEBU BABUR BAGAN	RUF A BIBI	KARIM SEEKH	489	GEN	YES	F	861860088894	7332987277	ALLA HABAD	TAKI	50323453544	
29	3	DAS PARA	TAPAN DAS	KAMAL DAS	541	GEN	NO	M	478554899826	9474157741	ALLA HABAD	TAKI	59115163300	
30	3	UTTARATI	BASINA DAS	NARAYAN DAS	344	GEN	NO	F	580443308429	9534701465	ALLA HABAD	TAKI	59170003709	
31	3	DAS PARA	DOLA DAS	DHIREN DAS	227	GEN	NO	F	717457059660	7632210107	ALLA HABAD	TAKI	7602210107	
32	3	RAMKESHNA PALLY LANE	PARAGHA RAY	MAHANDRA RAY	570	SC	NO	M	644215432532	7535837985	S. B. I	TAKI	32915567145	









Chhatrapati  
Taksi Municipality









Sl No.	Ward No	Slum/Non Slum	Name of the Beneficiary	Father's/ Husband's Name	Holding No. / Address	Category		Minority	Gender	Adhar No.	Mob No.	Bank Name	Branch	Bank Ac No	photo
						GENERAL/S.C./S.T./OBC									
1	4	MADAK PARA	AVA MODAK	AVHAY MODAK	732	GEN		NO	F	961133984515		ALLAHABAD	TAKI	21375583249	
2	4	PL RATAN BAZAR	KAUSHIK DAS	AJIT DAS	203	GEN		NO	M	636134514455		ALLAHABAD	TAKI	59051551417	
3	4	DUTTA PARA	SHE'ALI DEY	SUNIL DEY		GEN		NO	F	238623433476		ALLAHABAD	TAKI	21375572963	
4	4	TAIPATA TALA	PAPANI BASU	KOMAL KRISHNA MITRA	689	GEN		NO	F	383850958332		S.B.I	TAKI	32603330088	
5	4	BCSE PARA	PRAVAB DAS	KHIPISHI DAS	729	GEN		NO	M	602548664324		ALLAHABAD	TAKI	50097043968	
6	4	BCSE PARA	PRAJIP ROY CHOWDHURY	PANNA LAL ROY CHOWDHURY		GEN		NO	M	875470961306		ALLAHABAD	TAKI	21375565212	
7	4	PL RATAN BAZAR	BARUN KUMAR DUTTA	LAKHIPADA DUTTA	224	GEN		NO	M	454020780374		ALLAHABAD	TAKI	50147543641	
8	4	CHOWDHURY PARA	NAGEN DAS	CHANDI CHARAN DAS	135	GEN		NO	M	505622140768		ALLAHABAD	TAKI	21375568130	

Sl No.	Ward No	Slum/Non Slum	Name of the Beneficiary	Father's/ Husband's Name	Holding No. / Address	Category		Gender	Adhar No.	Mob No.	Bank Name	Branch	Bank Ac No	Photo
						General/S.C/S.T./OBC	Minority							
9	4	CF-OWDHURY PARA	PRAJIP DAS	KALIPADA DAS	191	GEN	NO	M	442405790179		ALLAHABAD	TAKI	50302293275	
10	4	TAIPATA TALA	TAPAN DEY	BADAL DEY	661	GEN	NO	M	497086219841		ALLAHABAD	TAKI	59055134952	
11	4	CF-OWDHURY PARA	PURNIMA CHANDA	SURESH CH.SAFKAR	575	GEN	NO	F	255491596713		ALLAHABAD	TAKI	21375594455	
12	4	TAIPATA TALA	BASJDEB CHANDA	UPANRA CHANDA	272	SC	NO	M	471013812197		ALLAHABAD	TAKI	21375554728	
13	4	PLRATAN BAZAR	SANDHYA DUTTA	RABINIRANATH DUTTA	639	GEN	NO	F	379725647230		ALLAHABAD	TAKI	50151234955	
14	4	TAIPATA TALA	ANL ROY	AJIT ROY	282	GEN	NO	F	940803891125		ALLAHABAD	TAKI	21375573490	
15	4	KLNDU PARA	RENJKA HALDAR	ASUTOSH HALDAR	96	GEN	NO	F	858883843561		ALLAHABAD	TAKI	21375548432	
16	4	DUTTA PARA	MAIJAN DAS	PAGAL DAS		GEN	NO	M	642110180180		ALLAHABAD	TAKI	59055170878	









Sl No.	Ward No	Slum/Non Slum	Name of the Beneficiary	Father's/ Husband's Name	Holding No. / Address	Category		Minority	Gender	Adhar No.	Mob No.	Bank Name	Branch	Bank Ac No	Photo
						GENERAL/S.C./ T./OBC	GEN								
17	4	PL RATAN BAZAR	SEPIALI DAS	ASHOK DAS	203	GEN	NO	F	67291691255			ALLAHABAD	TAKI	50288027680	
18	4	KL NDU PARA	KAMAL DEY	DIWABANDHU DEY	739	GEN	NO	M	571485507126			ALLAHABAD	TAKI	50099172531	
19	4	CLOWDHURY PARA	GOEINDA DEY	PREM CHAND DEY	157	GEN	NO	M	399766637108			ALLAHABAD	TAKI	21375548737	
20	4	BC SE PARA	BACHHU ADHIKARI	TARAK NATH ADHIKARI		SC	NO	M	271132631532			ALLAHABAD	TAKI	50161489584	
21	4	PL RATAN BAZAR	SHAMBHU MONDAL	DHIREJI MONDAL	276	SC	NO	M	987314770378			ALLAHABAD	TAKI	59055179630	
22	4	PL RATAN BAZAR	KALIDAS BISWAS	NIPENI RA NATH BISWAS		GEN	NO	M	918977916551			ALLAHABAD	TAKI	59136090448	
23	4	PL RATAN BAZAR	PAR MAL DAS	PARIMAL DAS	724	GEN	NO	M	705336046488			ALLAHABAD	TAKI	21375555894	
24	4	DUTTA PARA	NAREN DAS	NAREN DAS	383	GEN	NO	M	356886309290			ALLAHABAD	TAKI	50068809192	









Sl No.	Ward No	Slum/Non Slum	Name of the Beneficiary	Father's/ Husband's Name	Holding No. / Address	Category		Gender	Adhar No.	Mob No.	Bank Name	Branch	Bank Ac No	Photo
						GENERAL/S.C./S.T./OBC	Minority							
25	4	TAIPATA TALA	RATAN MONDAL	KARTICK MONDAL	256	SC	NO	M	641931164215		ALLAHABAD	TAKI	50269990373	
26	4	CFOWDHURY PARA	SAFHALI PATRA	BISTU PADA PATRA	106	SC	NO	F	975382046892		ALLAHABAD	TAKI	50158235077	
27	4	KLNDU PARA	KRISHNA PADA DAS	BIJAN DAS		GEN	NO	M	201259830095		U.B.I	HASNABAD	0144010111596	
28	4	DUTTAPA PARA	IRA DEY	DEBENDRA NATH DAS		GEN	NO	M	471342279449		ALLAHABAD	TAKI	50163547126	
29	4	KLNDU PARA	RANJIA HARI	HARICIRAN		GEN	NO	F	611112896539		ALLAHABAD	TAKI	21375548997	
30	4	KLNDU PARA	PRAJENJIT DAS	LAKSHMIKANTA DAS	777	GEN	NO	M	514088838522		ALLAHABAD	TAKI	50134221357	
31	4	TAKI	RANJIT DAS	BHUBAN MOHANDAS	477	SC	NO	M	865942174805		ALLAHABAD	TAKI	21375548396	
32	4	TEIPATA TALA	SABTRI MONDAL (KAHAR)	LT. DHIREN KAHAR	259	SC	NO	F	800189571613	9332080904	ALLAHABAD	TAKI	59099190850	



Sl No.	Ward No	Slum/Non Slum	Name of the Beneficiary	Father's/ Husband's Name	Holding No. / Address	Category		Gender	Adhar No.	Mob No.	Bank Name	Branch	Bank Ac No	Photo
						GENERAL/S.C/S.T./OBC	Minority							
1	5	DFRGA TALA	SWAKAT GAZI	MEHEF GAZI	10	OBC	YES	M	761215901848	8137783444	ALLAHABAD	TAKI	50097583053	
2	5	CHAR PARA	SUKJRLI GAZI	NURALI GAZI	95	OBC	YES	M	824723443657	7534942711	ALLAHABAD	TAKI	50097587649	
3	5	DFRGA TALA	SAMIR SAHA	ANIL SAHA	760	SC	NO	M	549202234994	8137860747	ALLAHABAD	TAKI	50298623490	
4	5	GHOSH PARA	PRAJOY DAS	SANKAR DAS	775	OBC	NO	M	568112289835	9732638333	ALLAHABAD	TAKI	50127493751	
5	5	DFSKHINARI PARA	AMINUR GAZI	NURUDDIN GAZI	137	OBC	YES	M	549803733297	7334919972	U. B. I	HASNABAD	0144010138282	
6	5	MANSINGHO RCAD	MAITU DAS	KANAI DAS	607	GEN	NO	M	893802577847	7534942711	ALLAHABAD	TAKI	50365291129	
7	5	MANSINGHO RCAD	BISWANATH DEBNATH	AMULYA DEBNATH	808	OBC	NO	M	435207892973	7737583617	ALLAHABAD	TAKI	59097413744	
8	5	MANSINGHO RCAD	SHYAMAL SARJAR	BABULAL SARDAR	765	OBC	NO	M	413484151849	7534942711	ALLAHABAD	TAKI	59095717677	

Sl No.	Ward No	Slum/Non Slum	Name of the Beneficiary	Fither's/ Husband's Name	Holding No. / Address	Category		Gender	Adhar No.	Mob No.	Bank Name	Branch	Bank Ac No	Photo
						General/S.C/S.T./OBC	Minority							
9	5	DLITTA PARA	MRITYUNJAY MOJAK	KALICHARAN MODAK	145	OBC	NO	M	567875436896	8670349826	ALLAHABAD	TAKI	59039713193	
10	5	CHAR PARA	ALHAMID SARJAR	NURALI SARDAR	41B	OBC	YES	M	269870633126	9033524372	ALLAHABAD	TAKI	50442831194	
11	5	DAKSHINARI PARA	DINI MOHAMMA D GAZI	NURUDDIN GAZI	121	OBC	YES	M	570024200151	9712826005	S. B. I	TAKI	31785941387	
12	5	GHOSH PARA	MAJAY DEY	ASHOK DEY	612	GEN	NO	M	336313896085	9517692183	ALLAHABAD	TAKI	59055251855	
13	5	GHOSH PARA	BANI CHATTERJEE	AMIYA MOHAN CHATTERJEE	105	GEN	NO	M	305267860996	9913643436	ALLAHABAD	TAKI	59039713386	
14	5	GHOSH PARA	SOLIMAN GAZI	NURUDDIN GAZI	41	OBC	YES	M	624670760889	7514942711	B. O. I	TAKI	415810110701894	
15	5	CHAR PARA	DIPTI PANJA	MADHIJ SUDA PANJA	575	GEN	NO	F	942434196002	7718579332	ALLAHABAD	TAKI	21375573887	
16	5	MANSINGHO RCAD	CHANDANA GHCSH	TARAPADA DAS	814	GEN	NO	F	330170168290	9712242146	ALLAHABAD	TAKI	59093601476	



















Sl No.	Ward No	Slum/Non Slum	Name of the Beneficiary	Father's/ Husband's Name	Holding No. / Address	Category		Minority	Gender	Adhar No.	Mob No.	Bank Name	Branch	Bank Ac. No	Photo
						General/S.C/S.T./OBC									
17	5	GHOSH PARA	PIJUS DAS	KHUDIRAM DAS	65	GEN		NO	M	454538951645	9033604194	ALLAHABAD	TAKI	50052263295	
18	5	MANSINGHO RCAD	MAIHU MOJDAL	LT. ISWAR CHANDRA MONDAL	37	OBC		NO	M	208225430300	9830297119	ALLAHABAD	TAKI	50492943802	
19	5	GHOSH PARA	SAMAD GAZI	CHATTAR GAZI	95	OBC		YES	M	650287429616	9517938745	ALLAHABAD	KUMARPUKUR	22258583437	
20	5	DUTTA PARA	IBRAHIM GAZI	BELA TALI GAZI	133	OBC		YES	M	899716372477	8539536156	S. B.I	TAKI	899716372477	
21	5	DESKHINARI PARA	SAIFUL GAZI	NOOR SLAM GAZI	442	OBC		YES	M	749818039701	8537903972	ALLAHABAD	TAKI	59056283972	
22	5	DESKHINARI PARA	KUTUBUDDIN GAZI	RAFIK L GAZI	458	OBC		YES	M	703089685336	8937500691	ALLAHABAD	TAKI	50321693349	
23	5	GHOSH PARA	PRAJANTA CHATTERJEE	SAROJ CHATTERJEE	122	GEN		NO	M	939268109748	7534942711	ALLAHABAD	TAKI	21375543715	
24	5	GHOSH PARA	SWA-DESH CHAKRABORTY	AMARINDRA CHAKRABORTY	517	GEN		NO	M	639074282426	8116718871	ALLAHABAD	TAKI	59056273920	









Sl No.	Ward No	Slum/Non Slum	Name of the Beneficiary	Father's/ Husband's Name	Holding No. / Address	Category		Gender	Adhar No.	Mob No.	Bank Name	Branch	Bank Ac. No	Photo
						General/S.C./ T./OBC	Minority							
25	5	GHOSH PARA	MAHADEB GHOSH	NAKUL GHOSH	365	OBC	NO	M	911802014665	7679622525	ALLAHABAD	TAKI	50379553802	
26	5	CHAR PARA	RAHIM SARDAR	NUR ALI SARDAR	623	OBC	YES	M	781861357758	8416285692	ALLAHABAD	TAKI	59136541895	
27	5	CHAR PARA	SUBHAS MALLICK	DHRUVO MALLICK	751	OBC	NO	M	650052743583	9775253075	ALLAHABAD	TAKI	59056271817	
28	5	MASJID PARA	ALEA BIBI	GARIB SAZI	119	OBC	YES	F	880843242493	9609569095	ALLAHABAD	TAKI	21375591466	
29	5	MASJID PARA	MRIDULA GHOSH	LT. GOYAL GHOSH	505	OBC	NO	F	451392219338	8937428506	ALLAHABAD	TAKI	21375553624	
30	5	DULTTA PARA	SUDIPTA MOJDAK	AJIT MOJDAK	645	OBC	NO	M	613096398948	7511722985	ALLAHABAD	TAKI	21375561765	
31	5	GHOSH PARA	MD. SAJAHAN ALI MONDAL	AJGAR ALI MONDAL	121	OBC	YES	M	578197323603	8670555411	ALLAHABAD	TAKI	50172303175	
32	5	DESKHINARI PARA	CHATTAR GAZI	ISMAIL GAZI	120	OBC	YES	M	498407437195	7534942711	ALLAHABAD	TAKI	50099001767	









Sl No.	Ward No	Slum/Non Slum	Name of the Beneficiary	Father's/ Husband's Name	Holding No. / Address	Category		Gender	Adhar No.	Mob No.	Bank Name	Branch	Bank Ac No	Photo
						GENERAL/S.C/S.T./OBC	Minority							
33	5	CF-OWDHURY PARA	SUJIT ACHARYYA	MALAY ACHARYYA	36B	GEN	NO	M	735698093192	9913602453	ALLAHABAD	TAKI	59058953402	
34	5	D/SKHNARI PARA	AJOY GHOSH	AJIT GHOSH	81B	OBC	NO	M	750212248581	9719218707	ALLAHABAD	TAKI	50097583520	
35	5	Non-Slum	Manas Das	Jatinciranath Das	32D	Gen	NO	M	713964871642		Allahabad	Taki	21375588770	

  
Chairman  
TAKI MUNICIPALITY

Sl No.	Ward No	Slum/Non Slum	Name of the Beneficiary	Father's/ Husband's Name	Holding No. / Address	Category		Minority	Gender	Adhar No.	Mob No.	Bank Name	Branch	Bank Ac. No	Photo
						GENERAL/S.C/s .T./OBC									
1	1	JALALPUR	SHIKHA GHOSH	RABINDRAGHOSH		GEN	NO	F	501642472754	9378325437	ALLA HABAD	TAKI	59056274492		
2	1	PASCHIM BEOKATI	SWAPAN SARKAR	DHIRENDRA NATH SARKAR	323	GEN	NO	M	654378468882		ALLA HABAD	TAKI	50102463075		
3	1	BEOKATI	UMA MONDAL	PRASENJIT MONDAL		SC	NO	F	961499794835	7033666399	S. B. I	TAKI	34059495118		
4	1	JALALPUR	SUJATA NATH	RANAJIT NATH		SC	NO	F	589395513746	7797578865	ALLA HABAD	TAKI	59055254240		
5	1	BEOKATI	YAMIUNA NATH	NIMAI NATH	270	OBC	NO	F	209346811755		ALLA HABAD	TAKI	50339421274		
6	1	JALALPUR	KARTIK CHAKRABORTY	BIMAL CHAKRABORTY	238	GEN	NO	M	335196753958		ALLA HABAD	TAKI	2137555960		
7	1	JALALPUR	DULAL GHOSH	SURJA KANTA GHOSH		GEN	NO	M	629181436059		ALLA HABAD	TAKI	21375574472		
8	1	PASCHIM BEOKATI	PRATAP NATH	RAJHYA NATH	267	GEN	NO	M	275814767273		S. B. I	TAKI	33047689659		

Sl No.	Ward No	Slum/Non Slum	Name of the Beneficiary	Father's/ Husband's Name	Holding No. / Address	Category		Minority	Gender	Adhar No.	Mob No.	Bank Name	Branch	Bank Ac. No	Photo
						General/S.C/S.T./OBC									
9	1	PASCHIM BEOKATI	TARUN PAL	KIRON PAL		GEN	NO	M	247967235193			U. B. I	HASNABAD	0144010146456	
10	1	BEOKATI	ACHINTA GHOSH	SUDARSHAN GHOSH	507	OBC	NO	M	523195516163	7548963200		ALLA HABAD	TAKI	50268624035	
11	1	JAJALPUR	GOKUL GHOSH	RANGALAL GHOSH		GEN	NO	M	205615387565	9734706175		ALLA HABAD	TAKI	21375587674	
12	1	PASCHIM BEOKATI	MONOJIT SARKAR	KANEK CHANDRA SARKAR	334	GEN	NO	M	399532503910			ALLA HABAD	TAKI	59099860511	
13	1	JAJALPUR	PABTRA DAS DAFADAR	SAMAFENDRA DAS DAFADAR		OBC	NO	M	893394347459			ALLA HABAD	TAKI	59097625058	
14	1	JAJALPUR	BIRASWAR DUTTA	DEEPAK KUMAR DUTTA	602	GEN	NO	M	781264007830	7872680491		ALLA HABAD	TAKI	59055253202	
15	1	JAJALPUR	SHIESANKAR DAS	AJAY DAS	27	GEN	NO	M	664472627337	9733651792		ALLA HABAD	TAKI	59055253246	
16	1	BEOKATI	NEMAI NATH	MADAN NATH	306	OBC	NO	M	216613015226	9639303830		S. B. I	TAKI	31952745098	









Sl No.	Ward No	Slum/Non Slum	Name of the Beneficiary	Father's/ Husband's Name	Holding No. / Address	Category		Gender	Adhar No.	Mob No.	Bank Name	Branch	Bank Ac. No	Photo
						General/S.C./S.T./OBC	Minority							
17	1	BEOKATI	TARAKNATH GHOSH	LT. GOPAL GHOSH	497	GEN	NO	M	624258863497	8348437707	ALLA HABAD	TAKI	50211933195	
18	1	JALALPUR	BISWANATH GHOSH	KALIPADA GHOSH	5	GEN	NO	M	267157463497	8957821878	ALLA HABAD	TAKI	59134909665	
19	1	JALALPUR	CHANDI DAS	KRISHNAPADA DAS	118	GEN	NO	M	588545890825	7477546340	ALLA HABAD	TAKI	59060052916	
20	1	JALALPUR	SUPARNA GHOSH	DEBRANJAN GHOSH	59	GEN	NO	F	338075416977	7053876185	ALLA HABAD	TAKI	59063225866	
21	1	PASCHIM BEOKATI	SANTU MONDAL	MADHUSUDAN MONDAL		SC	NO	M	595943335936	9333453339	ALLA HABAD	TAKI	59101414909	
22	1	JALALPUR	PARESH CHANDRA GHOSH	TENAPADA GHOSH	33	GEN	NO	M	592100699671		ALLA HABAD	TAKI	50371287919	
23	1	PASCHIM BEOKATI	SADHAN SARCAR	BHAJAHARI SARKAR	321	SC	NO	M	737169721402	8145236042	ALLA HABAD	TAKI	59039467452	
24	1	TAKI	SANTOSH KUMAR GAYEN	ATUL GAYEN	329	OBC	NO	M	465171983914		U. B. I	HASNABAD	0144010103275	









Sl No.	Ward No	Slum/Non Slum	Name of the Beneficiary	Father's/ Husband's Name	Holding No. / Address	Category		Minority	Gender	Adhar No.	Mob No.	Bank Name	Branch	Bank Ac. No	Photo
						GENERAL/S.C/S.T./OBC									
25	1	PASCHIM BEOKATI	SHAMPA SARKAR	AKHILESH SARKAR	333	SC		NO	F	715879150605		ALLA HABAD	TAKI	5905677235	
26	1	JA ALPUR	BIMAL DAS DAFADAR	HARU DAS DAFADAR	583	OBC		NO	M	877142443228	9857072331	ALLA HABAD	TAKI	50097213130	
27	1	JA ALPUR	GOFAL MONDAL	BINOD BIHARI MONDAL	87	SC		NO	M	616945412826	7602092347	ALLA HABAD	TAKI	50429157078	
28	1	JA ALPUR	PRAJIP BISWAS	KALIDAS BISWAS	548	OBC		NO	M	897665256480		ALLA HABAD	TAKI	50052863767	
29	1	HA SNABAD	SAVIT NATH	NAYAN NATH		OBC		NO	M	508972576355	9733720690	U. B. I	HASNABAD	0144010226424	
30	1	BEOKATI	SOBITA PAL	SADANANDA PAL	587	GEN		NO	F	532192367293	8915048834	ALLA HABAD	TAKI	50147981970	
31	1	BEOKATI	TANUSREE NATH	UJJIWA KUMAR NATH		OBC		NO	F	929280863238		B O.I	TAKI	415810110001163	
32	1	BEOKATI	GOFAL NATH	LT. DHIRENDRA NATH	265	OBC		NO	M	799782036863	9033902375	ALLA HABAD	TAKI	59039467509	









Sl No.	Ward No	Slum/Non Slum	Name of the Beneficiary	Father's/ Husband's Name	Holding No. / Address	Category GENERAL/S.C/s .T./OBC	Minority	Gender	Adhar No.	Mob No.	Bank Name	Branch	Bank Ac No	Photo
33	1	BECKATI	SUBRATA NATH	GOPAL NATH		OBC	NO	M	353234432097	9734748625	EOI	TAKI	415810110J01247	









  
Chairman  
TAKI MUNICIPALITY





Sl No.	Ward No	Slum/Non Slum	Name of the Beneficiary	Father's/ Husband's Name	Holding No. / Address	Category		Gender	Adhar No.	Mob No.	Bank Name	Branch	Bank Ac No	Photo
						General/S.C./S.T./OBC	Minority							
1	2	KAHAR PARA	PANCHANAN GHOSH	CHAND ICHARAN GHOSH	512	GEN	NO	M	86885527889	8016226740	B. C. V. B	HASANABAD	521701007647	
2	2	JELE PARA	SUBHASH MONDAL	SANTOSH MONDAL	524/105	SC	NO	M	475636896583	9718329620	ALLA -ABAD	TAKI	50307567298	
3	2	BEDKATI PARA	BISH MANARAYA N D/S	GANESH DAS	555	GEN	NO	M	962109462821	9913318990	ALLA -ABAD	TAKI	50364210693	
4	2	BCSE PARA	DIPANKAR MAHIDAL	AJIT MANDAL	187	SC	NO	M	854018559883	7011131490	ALLA -ABAD	TAKI	21375593098	
5	2	BEDKATI PARA	SANTA SARKAR	HARIKALI SARKAR	433	GEN	NO	M	205258647073	9033400227	ALLA -ABAD	TAKI	50124103558	
6	2	BEDKATI PARA	AMLIKA DAS	RAMKISHNO DAS	204	GEN	NO	F	205451744890	747676606	S. B. I	TAKI	30705331917	
7	2	JELE PARA	AMATYA MONDAL	DHANANJAY MONDAL	234	SC	NO	M	865916528578	8914899726	ALLA -ABAD	TAKI	21375552878	
8	2	BCSE PARA	SANKAR DALAL	HARENDRA NATH DALAL	710	OBC	NO	M	710306779381	9635958816	ALLA -ABAD	TAKI	59145113797	









Sl No.	Ward No	Slum/Non Slum	Name of the Beneficiary	Father's/ Husband's Name	Holding No. / Address	Category		Gender	Adhar No.	Mob No.	Bank Name	Branch	Bank Ac No	Photo
						GENERAL/S.C/S.T./OBC	Minority							
9	2	KAHAR PARA	GANESH MONDAL	ROBI MONDAL	617	SC	NO	M	409203382453	7334199607	ALLA HABAD	TAKI	50217321440	
10	2	JEJE PARA	RANIKRISHNA MONDAL	RATTAN MONDAL	581	SC	NO	M	717628608859	8917262802	ALLA HABAD	TAKI	50088913866	
11	2	BEDKATI PARA	DIPAK DAS	THAKUR CHARAN DAS	531	GEN	NO	M	550674218576	9617369947	ALLA HABAD	TAKI	50044754057	
12	2	JEJE PARA	CHABI MONDAL	AKHIL MONDAL	265	SC	NO	F	504508279430	7612093749	ALLA HABAD	TAKI	21375581203	
13	2	BEDKATI PARA	HIRJI GHOSH	MANIK GHOSH	477	OBC	NO	M	303285410939	8011841713	ALLA HABAD	TAKI	2137558194	
14	2	JEJE PARA	KRISHNA SAMADDER	NARENDRANATH	403	SC	NO	F	687696760886	9517953973	ALLA HABAD	TAKI	21375583025	
15	2	JEJE PARA	SUSMITH MONDAL	DULAL MONDAL	383	SC	NO	M	678046389568	8116645623	U. B. I	HASNABAD	0144010116734	
16	2	JEJE PARA	CHITTO MONDAL	DHANJAY MONDAL	234	SC	NO	M	608680768423	9517233246	ALLA HABAD	TAKI	59109944531	









Sl No.	Ward No	Slum/Non Slum	Name of the Beneficiary	Father's/ Husband's Name	Holding No. / Address	Category		Gender	Adhar No.	Mob No.	Bank Name	Branch	Bank Ac No	Photo
						GENERAL/S.C./S.T./OBC	Minority							
17	2	NI CARI PARA	CHADEK ALI GAZI	KENAT JILLA GAZI	453	GEN	YES	M	287452893273	8937362352	ALLA HABAD	TAKI	59055173119	
18	2	BCSE PARA	SAHADAT GAZI	NUR MAHAMMAD GAZI	391	GEN	YES	M	798842575346	70311764790	ALLA HABAD	TAKI	59140133308	
19	2	BCSE PARA	ABU BAKKAR SARJAR	SHAKAT SARDAR	351	OBC	NO	M	395850947287	7033679906	B. O. I	TAKI	415810110301104	
20	2	NI CARI PARA	MU'LIMA KHATUN BIBI	DIDAR BAKS MOLLA	5	OBC	NO	F	316060960303	9732605522	ALLA HABAD	TAKI	50140703189	
21	2	NI CARI PARA	ABDULLA MONDAL	SUJAUDDIN MONDAL	455	GEN	YES	M	706957398273	7632528139	ALLA HABAD	TAKI	21375563083	
22	2	JELE PARA	BELIAL GAZI	JAYAN/DDI GAZI	283	GEN	YES	M	701988827190	7033893347	ALLA HABAD	TAKI	59055173812	
23	2	JELE PARA	SAIFUL GAZI	BADEL GAZI	585	OBC	NO	M	591909704650	8145525769	ALLA HABAD	TAKI	50192053505	
24	2	BEOKATI PARA	AHAMMAD ALI GAZI	TENTE GAZI	601	GEN	YES	M	695567711774	9133748497	ALLA HABAD	TAKI	21375547541	

Sl No.	Ward No	Slum/Non Slum	Name of the Beneficiary	Father's/ Husband's Name	Holding No. / Address	Category		Gender	Adhar No.	Mob No.	Bank Name	Branch	Bank Ac No	Photo
						GENERAL/S.C./S.T./OBC	Minority							
25	2	NI CARI PARA	ANSAR GAZI	MANCHUR GAZI	960/392	OBC	NO	M	208444028439	8115826933	ALLA HABAD	TAKI	59057303749	
26	2	BEOKATI PARA	MATJUNA BIBI	MOMIN ALI GAZI	471	GEN	YES	F	225848232962	9715914929	ALLA HABAD	TAKI	21375573492	
27	2	BEOKATI PARA	SAN/SER GAZI	JUBBAIR GAZI	522	OBC	NO	M	756631495903	7334803146	ALLA HABAD	TAKI	21375583547	
28	2	NI CARI PARA	AANCHER GAZI	BARAKTULA GAZI	133	OBC	NO	M	701572557232	7332922580	ALLA HABAD	TAKI	50453113448	
29	2	NI CARI PARA	HARUN AL RAS D GAINE	MOBAIRAK GAINE	494	OBC	NO	M	444878213108	9635244046	U. B. I	HASNABAD	0144010225311	
30	2	JELE PARA	GOEIND MONDAL	PASHUPATI MONDAL	573	SC	NO	M	783194546213	8016947555	S. B. I	TAKI	35837553646	
31	2	JELE PARA	SOUMEN MONDAL	GOUTAM MONDAL	627	SC	NO	M	269620450450	8670751615	ALLA HABAD	TAKI	50086113479	
32	2	BEOKATI PARA	KARTICK CHANDRA GHOSH	BALAY CHANDRA GHOSH	603	OBC	NO	M	255099789458	9635254163	ALLA HABAD	TAKI	21375553699	

Sl No.	Ward No	Surn/Non Surn	Name of the Beneficiary	Father's/ Husband's Name	Holding No. / Address	Category		Gender	Adhar No.	Mob No.	Bank Name	Branch	Bank Ac No	Photo
						GENERAL/S.C./S.T./OBC	Minority							
33	2	JELE PARA	MAIJIK GAZI	TAHER ALI GAZI	450	OBC	NO	M	966607112216	8738216476	ALLA HABAD	TAKI	21375592979	
34	2	SAIDPUR	SHYAMA PRAJAD GHOSH	LET BISWANATH GHOSH	323	GEN	NO	M	451817938161	9378021995	ALLA HABAD	TAKI	21375593244	



Sl No.	Ward No	Slum/Non Slum	Name of the Beneficiary	Father's/ Husband's Name	Holding No. / Address	Category		Gender	Adhar No.	Mob No.	Bank Name	Branch	Bank Ac No	Photo
						General/S.C/S.T./OBC	Minority							
1	3	BEWAS PARA	BABUJAL DAS	MONIMOHAN DAS	47	GEN	NO	M	988290137648	9912781988	ALLA HABAD	TAKI	59065893884	
2	3	BEWAS PARA	GOLAM DAS	SAILENDRA NATH DAS	46	GEN	NO	M	210366880077	7832244996	ALLA HABAD	TAKI	21375563313	
3	3	DEBU BABUR BAGAN	MAVUVARA GAZI	CHATTAR GAZI	204	GEN	YES	F	987703306503	8937949773	ALLA HABAD	TAKI	50176393869	
4	3	DEBU BABUR BAGAN	MAJET SEKH	DIDAR SEKH		GEN	YES	M	615669216881	9639416041	ALLA HABAD	TAKI	50090433534	
5	3	UTTARPALLY	KRISHNA CHANDRA PAUL	SACHINDRA NATH PAUL	225	GEN	NO	M	528278922081	9639039748	ALLA HABAD	TAKI	21375573912	
6	3	RAJBANSI PARA	GOFAL MONDAL	KALIPADA MONDAL	210	SC	NO	M	806999223813	8937654551	ALLA HABAD	TAKI	21375553369	
7	3	DEBU BABUR BAGAN	AFSAR ALI GAZI	MOKTAR ALI GAZI		GEN	YES	M	559428062477	9639323890	S. B. I	TAKI	30987443945	
8	3	KLNDU PARA	MAIJHU SUDAN PAUL	LT. SAILANDRA NATH PAUL		OBC	NO	M	701508856638	8116964086	B. O. I	TAKI	415810110300371	

Sl No.	Ward No	Slum/Non Slum	Name of the Beneficiary	Father's/ Husb:nd's Name	Holding No. / Address	Category		Minority	Gender	Adhar No.	Mob No.	Bank Name	Branch	Bank Ac. No	Photo
						General/S.C/S.T./OBC	GEN								
9	3	KLNDU PARA	BHCLANATH DAS	AMULLYA DAS		GEN	NO	M	215258164279	7534818879	ALLA HABAD	TAKI	50099743779		
10	3	DEBU BABUR BAGAN	SAHAJAN GAZI	ATIARE GAZI	444	GEN	YES	M	206946755269	9679221739	ALLA HABAD	TAKI	2137555335		
11	3	UTTARPALLY	SHILILI DAS	BASUDEB DAS		GEN	NO	F	3713938873751	9312512495	ALLA HABAD	TAKI	50182021340		
12	3	BISWAS PARA	KANAI DAS	SANTOSH DAS	61D	GEN	NO	M	266564512957	9414613398	ALLA HABAD	TAKI	59102423364		
13	3	BISWAS PARA	SUBAL NATH	GANESH NATH	485	OBC	NO	M	975958986511	8972224926	ALLA HABAD	TAKI	21375547289		
14	3	KLNDU PARA	SHYAMALI PAUL	BANOMALI PAUL		OBC	NO	F		8116976517	ALLA HABAD	TAKI	50098504536		
15	3	BISWAS PARA	MRIYUNJAY MALLICK	BANKIM MALLICK	85	GEN	NO	M	299803378700	7033877899	U. B. I	HASNABAD	0144010335294		
16	3	DAS PARA	SHAMBU BISWAS	SHANTU BISWAS	21/21	OBC	NO	M	966904420236	9635959946	ALLA HABAD	TAKI	21375563121		

Chairman  
Taki Municipality