

Construction Storm Water Drain at Non slum
Ward No. 02

Length: 31.70 mtr.

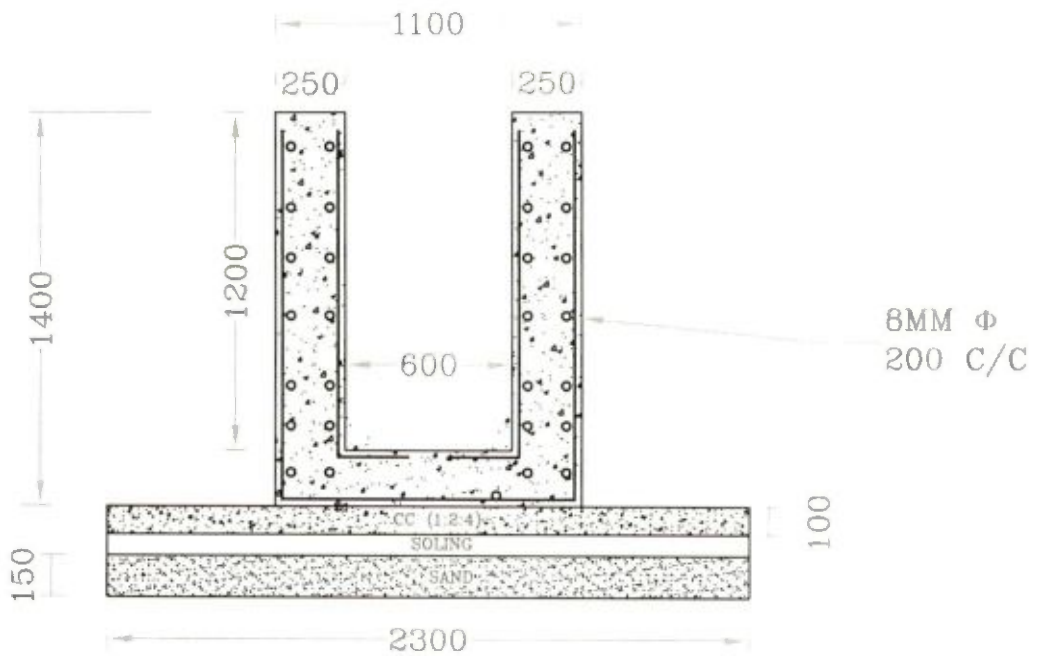

Drawn By:

Kandi Municipality

Chairman
Kandi Municipality

CHAIRMAN
KANDI MUNICIPALITY

Construction Storm Water Drain at Non Slum, at Ward No. 03

As per S. O. R 2015 P. W. D (Building) Schedule Effective From 01.11.2017 & 3rd CORRIGENDA & ADDENDA FOR SCHEDULE OF RATES OF PWD (W.B) wef 01.11.2017 Volume-I: (For Building Works, Materials & Labour)

Sl. NO.	Item	Quantity	unit	Rate Rs.	Amount Rs.
1	Earth work in excavation of foundation trenches or drains, in all sorts of soil (including mixed soil but excluding laterite or sandstone) including removing, spreading or stacking the spoils within a lead of 75 m.... complete. (a) Depth of excavation not exceeding 1,500 mm. { Page NO. - 01 Item NO. - 2 (a) }	3.97	Cum	119.27	473.20
2	Filling in foundation or plinth by silver sand in layers not exceeding 150 mm etc { Page NO. - 02 Item NO. - 4 (A) }	0.35	cum	599.61	206.87
3	Single Brick Flat Soling of picked jhama bricks including ramming and dressing bed to proper level and filling joints with local sand. { Page NO. - 14 Item NO. - 1 }	2.30	sqm	324.00	745.20
	Cement concrete with graded Stone (30mm. Size excluding shuttering) In ground floor A) [Pakur Variety] 1:3:6 Page - 34, It. 22.	0.23	cum	5189	1,193.47
5	Ordinary Cement concrete (mix 1:1.5:3) with graded stone chips (20 mm nominal size) excluding shuttering and reinforcement if any, in ground floor as per relevant IS codes. (Panchami variety) { Page NO.- 26 Item NO. - 10 (iv) }	0.82	cum	6194.77	5,079.71
6	Reinforcement for reinforced concrete work in all sorts of structures including distribution bars, stirrups binders etc. including supply of rods, initial straightening and removal of loose rust (if necessary), cutting to requisite length, hooking and beneding to correct shape, placing in propret position and binding with 16 guage black annealed wire at every inter-section, complete as per drawing and direction. (a) for works in foundation, basement and upto roof of ground floor/upto 4m. (i) tor steel/mild steel. Page - 40 (a) (i) (i) II other than TATA /SAIL/RSNL	0.064	MT	64906.15	4,153.99
7	Plaster (to wall, floor, ceiling etc.) with sand and cement mortar including rounding off or (i) With 1:6 cement mortar (c) 15 mm thick plaster { Page: 189 Item NO. - 1(ii) (c) }	3.50	Sqm	142.00	497.00
	Neat cement punning about 1.5mm thick in wall, dado, window sill, floor etc. NOTE:Cement 0.152 cu.m per100 sq.m. (Page - 192 Item - 15)	3.50	Sqm	34.00	119.00
9	Hire and labour charges for shuttering with centering and necessary staging upto 4 m and striking out after completion of works (upto roof of ground floor) (c) Steel shuttering or 9 to 12 mm. thick approved quality ply board shuttering in any concrete work. { Page NO.- 42 Item NO. - 36 (c) }	5.20	sqm	365.00	1,898.00

Rs. 14366.44

Add GST @ 12 % as applicable Rs. 1723.97

Sub total Rs. 16090.41

Add Labour welfare cess @ 1 % Rs. 160.90

Total Rs. 16251.31

Per Metr. Cost=
11.32 Mtr Drain=

Say Rs. 16251.00
Rs. 183961.00

Prepared By -

S. A. E.
Kandi Municipality
SAE
Kandi Municipality

Chairman
Kandi Municipality
CHAIRMAN
KANDI MUNICIPALITY

Construction Storm Water Drain at Non slum
Ward No. 03

Length: 11.32 mtr.

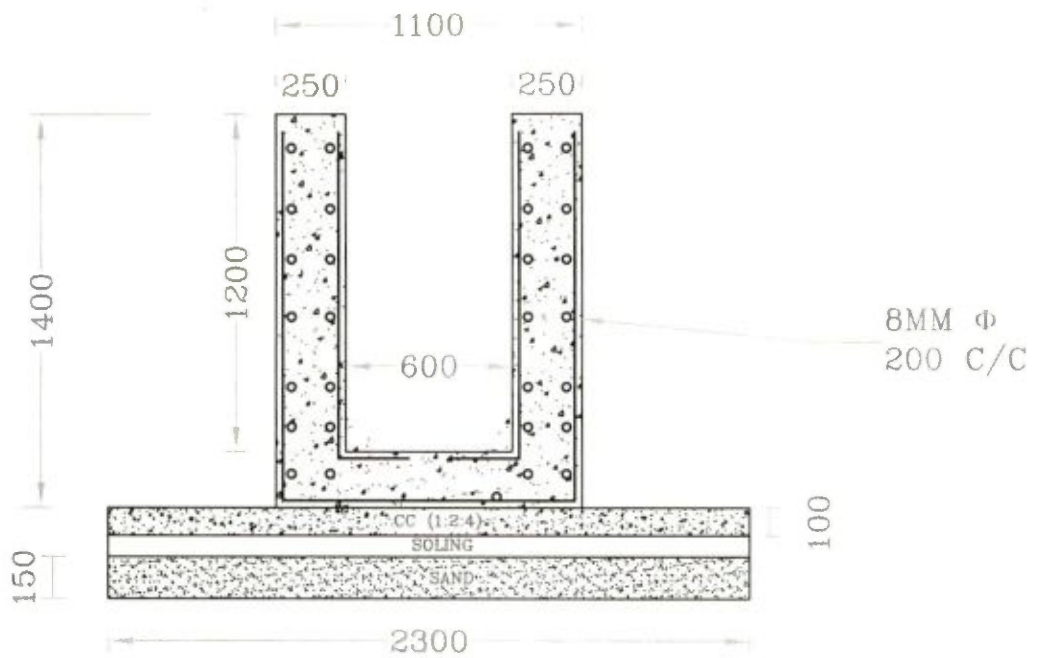

Drawn By:

SAE
Kandi Municipality

Chairman
Kandi Municipality

CHAIRMAN
KANDI MUNICIPALITY

Construction Storm Water Drain at Non Slum, at Ward No. 04

As per S. O. R 2015 P. W. D (Building) Schedule Effective From 01.11.2017 & 3rd CORRIGENDA & ADDENDA FOR SCHEDULE OF RATES OF PWD (W.B) wef 01.11.2017 Volume-I: (For Building Works, Materials & Labour)

SL NO.	Item	Quantity	unit	Rate Rs.	Amount Rs.
1	Earth work in excavation of foundation trenches or drains, in all sorts of soil (including mixed soil but excluding laterite or sandstone) including removing, spreading or stacking the spoils within a lead of 75 m.... complete. (a) Depth of excavation not exceeding 1,500 mm. { Page NO. - 01 Item NO. - 2 (a) }	3.97	Cum	119.27	473.20
2	Filling in foundation or plinth by silver sand in layers not exceeding 150 mm etc { Page NO. - 02 Item NO. - 4 (A) }	0.35	cum	599.61	206.87
3	Single Brick Flat Soling of picked jhama bricks including ramming and dressing bed to proper level and filling joints with local sand. { Page NO. - 14 Item NO. - 1 }	2.30	sqm	324.00	745.20
-	Cement concrete with graded Stone (30mm. Size excluding shuttering) In ground floor A) [Pakur Variety] 1:3:6 Page - 34, It. 22.	0.23	cum	5189	1,193.47
5	Ordinary Cement concrete (mix 1:1.5:3) with graded stone chips (20 mm nominal size) excluding shuttering and reinforcement if any, in ground floor as per relevant IS codes. (Panchami variety) { Page NO.- 26 Item NO. - 10 (iv) }	0.82	cum	6194.77	5,079.71
6	Reinforcement for reinforced concrete work in all sorts of structures including distribution bars, stirrups binders etc. including supply of rods, initial straightening and removal of loose rust (if necessary), cutting to requisite length, hooking and beneding to correct shape, placing in propret position and binding with 16 guage black annealed wire at every inter-section, complete as per drawing and direction. (a) for works in foundation, basement and upto roof of ground floor/upto 4m. (i) tor steel/mild steel. Page - 40 (a) (i) (i) II other than TATA /SAIL/RSNL	0.064	MT	64906.15	4,153.99
7	Plaster (to wall, floor, ceiling etc.) with sand and cement mortar including rounding off or (i) With 1:6 cement mortar (c) 15 mm thick plaster { Page: 189 Item NO. - 1(ii) (c) }	3.50	Sqm	142.00	497.00
	Neat cement punning about 1.5mm thick in wall, dado, window sill, floor etc. NOTE:Cement 0.152 cu.m per 100 sq.m. (Page - 192 Item - 15)	3.50	Sqm	34.00	119.00
9	Hire and labour charges for shuttering with centering and necessary staging upto 4 m and striking out after completion of works (upto roof of ground floor) (c) Steel shuttering or 9 to 12 mm. thick approved quality ply board shuttering in any concrete work. { Page NO.- 42 Item NO. - 36 (c) }	5.20	sqm	365.00	1,898.00

Rs. 14366.44

Add GST @ 12 % as applicable Rs. 1723.97

Sub total Rs. 16090.41

Add Labour welfare cess @ 1 % Rs. 160.90

Total Rs. 16251.31

Per Metr. Cost=
40.76 Mtr Drain=

Say Rs. 16251.00

Rs. 662391.00

Prepar.

S. A. E.
Kandi Municipality
S.A.E.
Kandi Municipality

Chairman
Kandi Municipality
CHAIRMAN
KANDI MUNICIPALITY

Construction Storm Water Drain at Non slum
Ward No. 04

Length: 40.76 mtr.

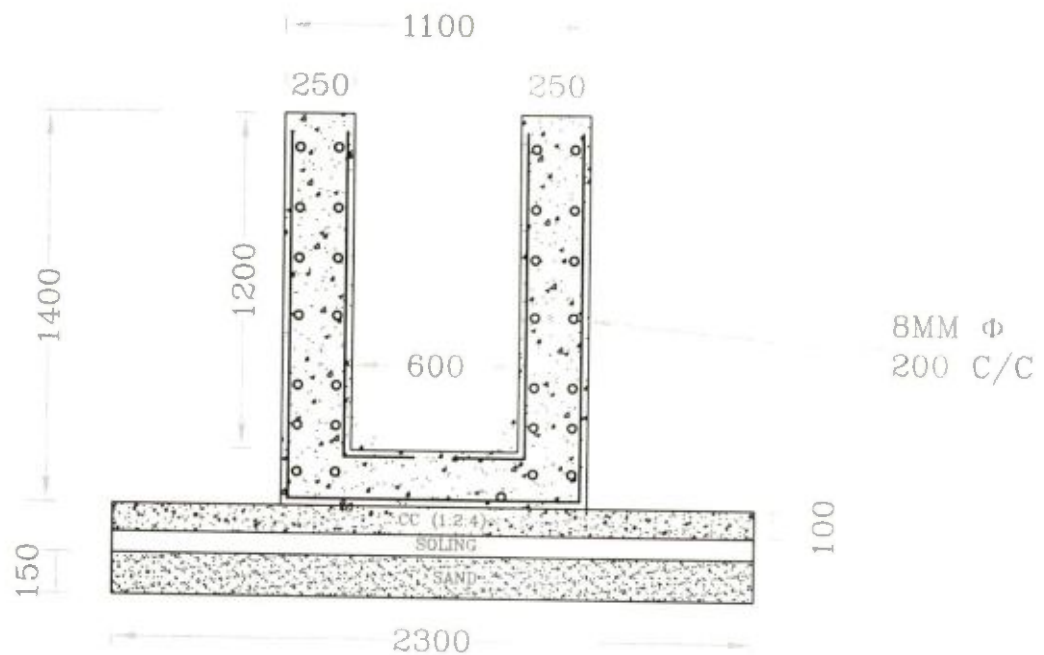

Drawn By:

SAE
Kandi Municipality

Chairman
Kandi Municipality

CHAIRMAN
KANDI MUNICIPALITY

Construction Storm Water Drain at Non Slum, at Ward No. 05

As per S. O. R. 2015 P. W. D (Building) Schedule Effective From 01.11.2017 & 3rd CORRIGENDA & ADDENDA FOR SCHEDULE OF RATES OF PWD (W.B) wef 01.11.2017 Volume-I: (For Building Works, Materials & Labour)

Sl. NO.	Item	Quantity	unit	Rate Rs.	Amount Rs.
1	Earth work in excavation of foundation trenches or drains, in all sorts of soil (including mixed soil but excluding laterite or sandstone) including removing, spreading or stacking the spoils within a lead of 75 m.... complete. (a) Depth of excavation not exceeding 1,500 mm. { Page NO. - 01 Item NO. - 2 (a) }	3.97	Cum	119.27	473.20
2	Filling in foundation or plinth by silver sand in layers not exceeding 150 mm etc { Page NO. - 02 Item NO. - 4 (A) }	0.35	cum	599.61	206.87
3	Single Brick Flat Soling of picked jhama bricks including ramming and dressing bed to proper level and filling joints with local sand. { Page NO. - 14 Item NO. - 1 }	2.30	sqm	324.00	745.20
4	Cement concrete with graded Stone (30mm. Size excluding shuttering) In ground floor A) [Pakur Variety] 1:3:6 Page - 34, It. 22.	0.23	cum	5189	1,193.47
5	Ordinary Cement concrete (mix 1:1.5:3) with graded stone chips (20 mm nominal size) excluding shuttering and reinforcement if any, in ground floor as per relevant IS codes. (Panchami variety) { Page NO.- 26 Item NO. - 10 (iv) }	0.82	cum	6194.77	5,079.71
6	Reinforcement for reinforced concrete work in all sorts of structures including distribution bars, stirrups binders etc. including supply of rods, initial straightening and removal of loose rust (if necessary), cutting to requisite length, hooking and beneding to correct shape, placing in propret position and binding with 16 guage black annealed wire at every inter-section, complete as per drawing and direction. (a) for works in foundation, basement and upto roof of ground floor/upto 4m. (i) tor steel/mild steel. Page - 40 (a) (i) (i) II other than TATA /SAIL/RSNL	0.064	MT	64906.15	4,153.99
7	Plaster (to wall, floor, ceiling etc.) with sand and cement mortar including rounding off or (i) With 1:6 cement mortar (c) 15 mm thick plaster { Page: 189 Item NO. - 1(ii) (c) }	3.50	Sqm	142.00	497.00
8	Neat cement punning about 1.5mm thick in wall, dado, window sill, floor etc. NOTE:Cement 0.152 cu.m per100 sq.m. (Page - 192 Item - 15)	3.50	Sqm	34.00	119.00
9	Hire and labour charges for shuttering with centering and necessary staging upto 4 m and striking out after completion of works (upto roof of ground floor) (c) Steel shuttering or 9 to 12 mm. thick approved quality ply board shuttering in any concrete work. { Page NO.- 42 Item NO. - 36 (c) }	5.20	sqm	365.00	1,898.00

Rs. 14366.44

Add GST @ 12 % as applicable Rs. 1723.97

Sub total Rs. 16090.41

Add Labour welfare cess @ 1 % Rs. 160.90

Total Rs. 16251.31

Per Metr. Cost=
11.34 Mtr Drain=

Say Rs. 16251.00
Rs. 184286.00

Prepared By -

S. A. E.
Kandi Municipality
SAE
Kandi Municipality

Chairman
Kandi Municipality
CHAIRMAN
KANDI MUNICIPALITY

Construction StormWater Drain at Non slum
Ward No. 05

Length: 11.34 mtr.

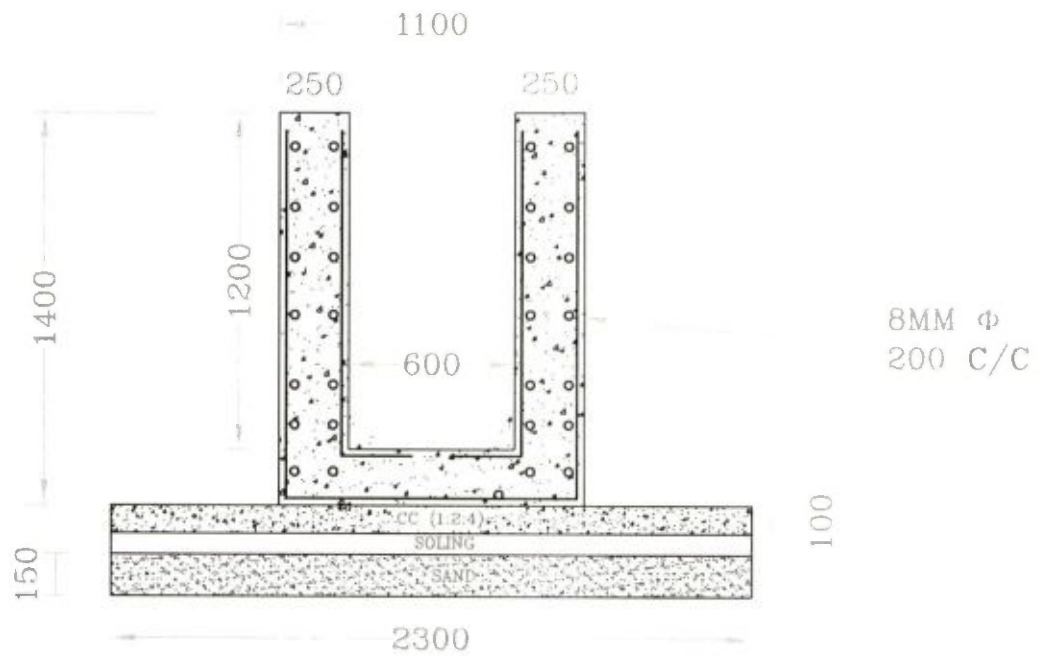

Drawn By:

Kandi Municipality

Chairman
Kandi Municipality

CHAIRMAN
KANDI MUNICIPALITY

Construction Storm Water Drain at Non Slum, at Ward No. 06

As per S. O. R. 2015 P. W. D (Building) Schedule Effective From 01.11.2017 & 3rd CORRIGENDA & ADDENDA FOR SCHEDULE OF RATES OF PWD (W.B) wef 01.11.2017 Volume-I: (For Building Works, Materials & Labour)

Sl. NO.	Item	Quantity	unit	Rate Rs.	Amount Rs.
1	Earth work in excavation of foundation trenches or drains, in all sorts of soil (including mixed soil but excluding laterite or sandstone) including removing, spreading or stacking the spoils within a lead of 75 m.... complete. (a) Depth of excavation not exceeding 1,500 mm. { Page NO. - 01 Item NO. - 2 (a) }	3.97	Cum	119.27	473.20
2	Filling in foundation or plinth by silver sand in layers not exceeding 150 mm etc { Page NO. - 02 Item NO. - 4 (A) }	0.35	cum	599.61	206.87
3	Single Brick Flat Soling of picked jhama bricks including ramming and dressing bed to proper level and filling joints with local sand. { Page NO. - 14 Item NO. - 1 }	2.30	sqm	324.00	745.20
	Cement concrete with graded Stone (30mm. Size excluding shuttering) In ground floor A) [Pakur Variety] 1:3:6 Page - 34, It. 22.	0.23	cum	5189	1,193.47
5	Ordinary Cement concrete (mix 1:1.5:3) with graded stone chips (20 mm nominal size) excluding shuttering and reinforcement if any, in ground floor as per relevant IS codes. (Panchami variety) { Page NO.- 26 Item NO. - 10 (iv) }	0.82	cum	6194.77	5,079.71
6	Reinforcement for reinforced concrete work in all sorts of structures including distribution bars, stirrups binders etc. including supply of rods, initial straightening and removal of loose rust (if necessary), cutting to requisite length, hooking and beneding to correct shape, placing in propret position and binding with 16 guage black annealed wire at every inter-section, complete as per drawing and direction. (a) for works in foundation, basement and upto roof of ground floor/upto 4m. (i) tor steel/mild steel. Page - 40 (a) (i) (i) II other than TATA /SAIL/RSNL	0.064	MT	64906.15	4,153.99
7	Plaster (to wall, floor, ceiling etc.) with sand and cement mortar including rounding off or (i) With 1:6 cement mortar (c) 15 mm thick plaster { Page: 189 Item NO. - 1(ii) (c) }	3.50	Sqm	142.00	497.00
	Neat cement punning about 1.5mm thick in wall, dado, window sill, floor etc. NOTE:Cement 0.152 cu.m per100 sq.m. (Page - 192 Item - 15)	3.50	Sqm	34.00	119.00
9	Hire and labour charges for shuttering with centering and necessary staging upto 4 m and striking out after completion of works (upto roof of ground floor) (c) Steel shuttering or 9 to 12 mm. thick approved quality ply board shuttering in any concrete work. { Page NO.- 42 Item NO. - 36 (c) }	5.20	sqm	365.00	1,898.00

Rs. 14366.44

Add GST @ 12 % as applicable Rs. 1723.97

Sub total Rs. 16090.41

Add Labour welfare cess @ 1 % Rs. 160.90

Total Rs. 16251.31

Per Metr. Cost=
11.34 Mtr Drain=

Say Rs. 16251.00

Rs. 184286.00

Prepared By -

S.A.E.
Kandi Municipality
Kandi Municipality

Chairman
Kandi Municipality
CHAIRMAN
KANDI MUNICIPALITY

Construction Storm Water Drain at Non slum
Ward No. 06

Length: 11.34 mtr.

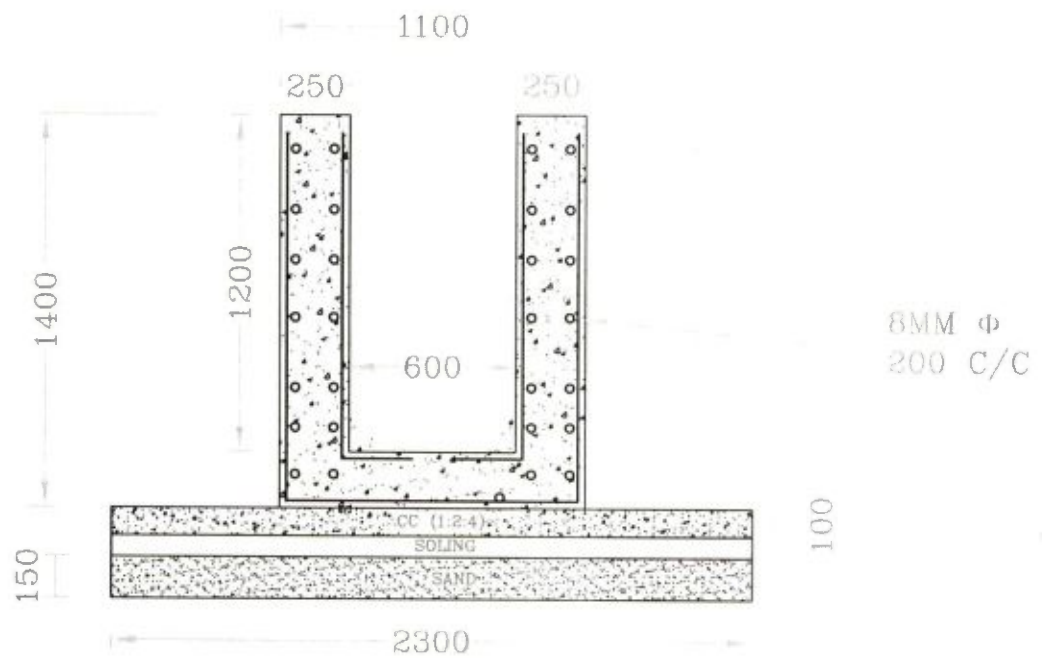

Drawn By:

Kandi Municipality

Chairman
Kandi Municipality
CHAIRMAN
KANDI MUNICIPALITY

Construction Storm Water Drain at Non Slum, at Ward No. 7

As per S. O. R 2015 P. W. D (Building) Schedule Effective From 01.11.2017 & 3rd CORRIGENDA & ADDENDA FOR SCHEDULE OF RATES OF PWD (W.B) wef 01.11.2017 Volume-I: (For Building Works, Materials & Labour)

SL NO.	Item	Quantity	unit	Rate Rs.	Amount Rs.
1	Earth work in excavation of foundation trenches or drains, in all sorts of soil (including mixed soil but excluding laterite or sandstone) including removing, spreading or stacking the spoils within a lead of 75 m.... complete. (a) Depth of excavation not exceeding 1,500 mm. { Page NO. - 01 Item NO. - 2 (a) }	3.97	Cum	119.27	473.20
2	Filling in foundation or plinth by silver sand in layers not exceeding 150 mm etc { Page NO. - 02 Item NO. - 4 (A) }	0.35	cum	599.61	206.87
3	Single Brick Flat Soling of picked jhama bricks including ramming and dressing bed to proper level and filling joints with local sand. { Page NO. - 14 Item NO. - 1 }	2.30	sqm	324.00	745.20
	Cement concrete with graded Stone (30mm. Size excluding shuttering) In ground floor A) [Pakur Variety] 1:3:6 Page - 34, It. 22.	0.23	cum	5189	1,193.47
5	Ordinary Cement concrete (mix 1:1.5:3) with graded stone chips (20 mm nominal size) excluding shuttering and reinforcement if any, in ground floor as per relevant IS codes. (Panchami variety) { Page NO.- 26 Item NO. - 10 (iv) }	0.82	cum	6194.77	5,079.71
6	Reinforcement for reinforced concrete work in all sorts of structures including distribution bars, stirrups binders etc. including supply of rods, initial straightening and removal of loose rust (if necessary), cutting to requisite length, hooking and beneding to correct shape, placing in propret position and binding with 16 guage black annealed wire at every inter-section, complete as per drawing and direction. (a) for works in foundation, basement and upto roof of ground floor/upto 4m. (i) tor steel/mild steel. Page - 40 (a) (i) (i) II other than TATA /SAIL/RSNL	0.064	MT	64906.15	4,153.99
7	Plaster (to wall, floor, ceiling etc.) with sand and cement mortar including rounding off or (i) With 1:6 cement mortar (c) 15 mm thick plaster { Page: 189 Item NO. - 1(ii) (c) }	3.50	Sqm	142.00	497.00
	Neat cement punning about 1.5mm thick in wall, dado, window sill, floor etc. NOTE:Cement 0.152 cu.m per100 sq.m. (Page - 192 Item - 15)	3.50	Sqm	34.00	119.00
9	Hire and labour charges for shuttering with centering and necessary staging upto 4 m and striking out after completion of works (upto roof of ground floor) (c) Steel shuttering or 9 to 12 mm. thick approved quality ply board shuttering in any concrete work. { Page NO.- 42 Item NO. - 36 (c) }	5.20	sqm	365.00	1,898.00

Rs. 14366.44

Add GST @ 12 % as applicable Rs. 1723.97

Sub total Rs. 16090.41

Add Labour welfare cess @ 1 % Rs. 160.90

Total Rs. 16251.31

Per Metr. Cost=
49.82 Mtr Drain=

Say Rs. 16251.00

Rs. 809625.00

Prepared By -

S. A. E.
Kandi Municipality
SAE
Kandi Municipality

Chairman
Kandi Municipality
CHAIRMAN
KANDI MUNICIPALITY

Construction Storm Water Drain at Non slum
Ward No. 07

Length: 49.82 mtr.

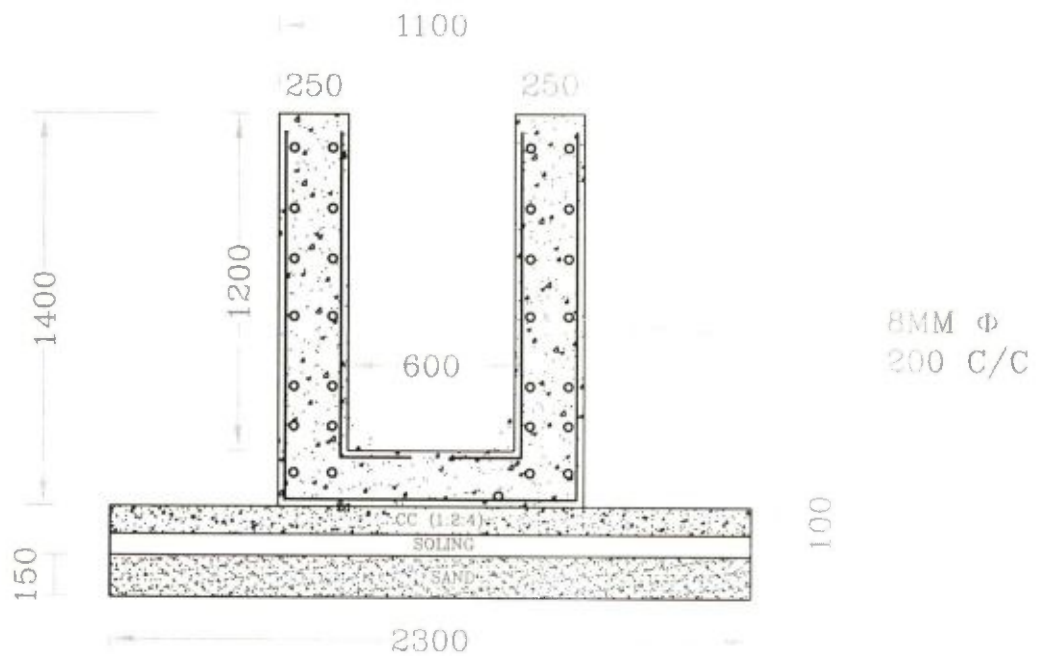

Drawn By:

Kandi Municipality

Chairman
Kandi Municipality

CHAIRMAN
KANDI MUNICIPALITY

Construction Storm Water Drain at Non Slum, at Ward No. 09

As per S. O. R 2015 P. W. D (Building) Schedule Effective From 01.11.2017 & 3rd CORRIGENDA & ADDENDA FOR SCHEDULE OF RATES OF PWD (W.B) wef 01.11.2017 Volume-I: (For Building Works, Materials & Labour)

Sl. NO.	Item	Quantity	unit	Rate Rs.	Amount Rs.
1	Earth work in excavation of foundation trenches or drains, in all sorts of soil (including mixed soil but excluding laterite or sandstone) including removing, spreading or stacking the spoils within a lead of 75 m.... complete. (a) Depth of excavation not exceeding 1,500 mm. { Page NO. - 01 Item NO. - 2 (a) }	3.97	Cum	119.27	473.20
2	Filling in foundation or plinth by silver sand in layers not exceeding 150 mm etc { Page NO. - 02 Item NO. - 4 (A) }	0.35	cum	599.61	206.87
3	Single Brick Flat Soling of picked jhama bricks including ramming and dressing bed to proper level and filling joints with local sand. { Page NO. - 14 Item NO. - 1 }	2.30	sqm	324.00	745.20
	Cement concrete with graded Stone (30mm. Size excluding shuttering) In ground floor A) [Pakur Variety] 1:3:6 Page - 34, It. 22.	0.23	cum	5189	1,193.47
5	Ordinary Cement concrete (mix 1:1.5:3) with graded stone chips (20 mm nominal size) excluding shuttering and reinforcement if any, in ground floor as per relevant IS codes. (Panchami variety) { Page NO.- 26 Item NO. - 10 (iv) }	0.82	cum	6194.77	5,079.71
6	Reinforcement for reinforced concrete work in all sorts of structures including distribution bars, stirrups binders etc. including supply of rods, initial straightening and removal of loose rust (if necessary), cutting to requisite length, hooking and beneding to correct shape, placing in propret position and binding with 16 guage black annealed wire at every inter-section, complete as per drawing and direction. (a) for works in foundation, basement and upto roof of ground floor/upto 4m. (i) tor steel/mild steel. Page - 40 (a) (i) (i) II other than TATA /SAIL/RSNL	0.064	MT	64906.15	4,153.99
7	Plaster (to wall, floor, ceiling etc.) with sand and cement mortar including rounding off or (i) With 1:6 cement mortar (c) 15 mm thick plaster { Page: 189 Item NO. - 1(ii) (c) }	3.50	Sqm	142.00	497.00
	Neat cement punning about 1.5mm thick in wall, dado, window sill, floor etc. NOTE:Cement 0.152 cu.m per100 sq.m. (Page - 192 Item - 15)	3.50	Sqm	34.00	119.00
9	Hire and labour charges for shuttering with centering and necessary staging upto 4 m and striking out after completion of works (upto roof of ground floor) (c) Steel shuttering or 9 to 12 mm. thick approved quality ply board shuttering in any concrete work. { Page NO.- 42 Item NO. - 36 (c) }	5.20	sqm	365.00	1,898.00

Rs. 14366.44

Add GST @ 12 % as applicable Rs. 1723.97

Sub total Rs. 16090.41

Add Labour welfare cess @ 1 % Rs. 160.90

Total Rs. 16251.31

Per Metr. Cost=
31.70 Mtr Drain=

Say Rs. 16251.00

Rs. 515157.00

Prepared By -



S. A. E.
Kandi Municipality
SAE
Kandi Municipality

Chairman

Kandi Municipality
CHAIRMAN
KANDI MUNICIPALITY

Construction Storm Water Drain at Non slum
Ward No. 09

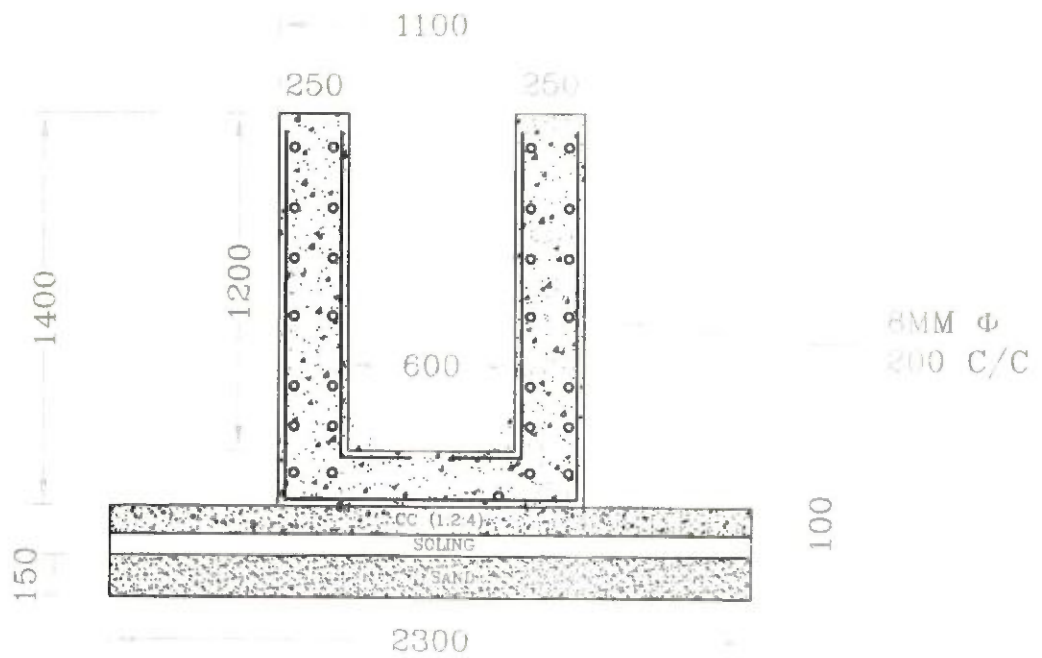
Length: 31.70 mtr.



Drawn By:

SAE
Kandi Municipality

Chairman
Kandi Municipality

CHAIRMAN
KANDI MUNICIPALITY

Construction Storm Water Drain at Non Slum, at Ward No. 11

As per S. O. R 2015 P. W. D (Building) Schedule Effective From 01.11.2017 & 3rd CORRIGENDA & ADDENDA FOR SCHEDULE OF RATES OF PWD (W.B) wef 01.11.2017 Volume-I: (For Building Works, Materials & Labour)

Sl. NO.	Item	Quantity	unit	Rate Rs.	Amount Rs.
1	Earth work in excavation of foundation trenches or drains, in all sorts of soil (including mixed soil but excluding laterite or sandstone) including removing, spreading or stacking the spoils within a lead of 75 m.... complete. (a) Depth of excavation not exceeding 1,500 mm. { Page NO. - 01 Item NO. - 2 (a) }	3.97	Cum	119.27	473.20
2	Filling in foundation or plinth by silver sand in layers not exceeding 150 mm etc { Page NO. - 02 Item NO. - 4 (A) }	0.35	cum	599.61	206.87
3	Single Brick Flat Soling of picked jhama bricks including ramming and dressing bed to proper level and filling joints with local sand. { Page NO. - 14 Item NO. - 1 }	2.30	sqm	324.00	745.20
	Cement concrete with graded Stone (30mm. Size excluding shuttering) In ground floor A) [Pakur Variety] 1:3:6 Page - 34, It. 22.	0.23	cum	5189	1,193.47
5	Ordinary Cement concrete (mix 1:1.5:3) with graded stone chips (20 mm nominal size) excluding shuttering and reinforcement if any, in ground floor as per relevant IS codes. (Panchami variety) { Page NO.- 26 Item NO. - 10 (iv) }	0.82	cum	6194.77	5,079.71
6	Reinforcement for reinforced concrete work in all sorts of structures including distribution bars, stirrups binders etc. including supply of rods, initial straightening and removal of loose rust (if necessary), cutting to requisite length, hooking and beneding to correct shape, placing in propret position and binding with 16 guage black annealed wire at every inter-section, complete as per drawing and direction. (a) for works in foundation, basement and upto roof of ground floor/upto 4m. (i) tor steel/mild steel. Page - 40 (a) (i) (i) II other than TATA /SAIL/RSNL	0.064	MT	64906.15	4,153.99
7	Plaster (to wall, floor, ceiling etc.) with sand and cement mortar including rounding off or (i) With 1:6 cement mortar (c) 15 mm thick plaster { Page: 189 Item NO. - 1(ü) (c) }	3.50	Sqm	142.00	497.00
	Neat cement punning about 1.5mm thick in wall, dado, window sill, floor etc. NOTE:Cement 0.152 cu.m per100 sq.m. (Page - 192 Item - 15)	3.50	Sqm	34.00	119.00
9	Hire and labour charges for shuttering with centering and necessary staging upto 4 m and striking out after completion of works (upto roof of ground floor) (c) Steel shuttering or 9 to 12 mm. thick approved quality ply board shuttering in any concrete work. { Page NO.- 42 Item NO. - 36 (c) }	5.20	sqm	365.00	1,898.00

Rs. 14366.44

Add GST @ 12 % as applicable Rs. 1723.97

Sub total Rs. 16090.41

Add Labour welfare cess @ 1 % Rs. 160.90

Total Rs. 16251.31

Per Metr. Cost=
27.17 Mtr Drain=

Say Rs. 16251.00
Rs. 441540.00

Prepared By -

S.A.E.
Kandi Municipality
Kandi Municipality

Chairman
Kandi Municipality
KANDI MUNICIPALITY

Construction Storm Water Drain at Non slum Ward No. 11

Length: 27.17 mtr.

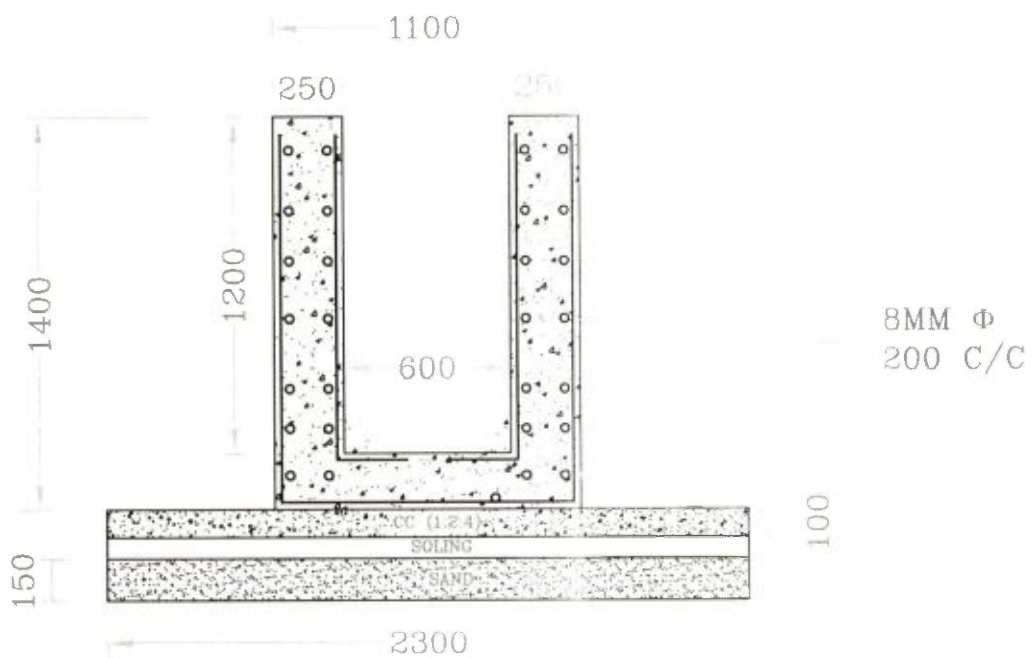

Drawn By:

SAE
Kandi Municipality

Chairman
Kandi Municipality

CHAIRMAN
KANDI MUNICIPALITY

Construction Storm Water Drain at Non Slum, at Ward No. 12

As per S. O. R 2015 P. W. D (Building) Schedule Effective From 01.11.2017 & 3rd CORRIGENDA & ADDENDA FOR SCHEDULE OF RATES OF PWD (W.B) wef 01.11.2017 Volume-I: (For Building Works, Materials & Labour)

Sl. NO.	Item	Quantity	unit	Rate Rs.	Amount Rs.
1	Earth work in excavation of foundation trenches or drains, in all sorts of soil (including mixed soil but excluding laterite or sandstone) including removing, spreading or stacking the spoils within a lead of 75 m.... complete. (a) Depth of excavation not exceeding 1,500 mm. { Page NO. - 01 Item NO. - 2 (a) }	3.97	Cum	119.27	473.20
2	Filling in foundation or plinth by silver sand in layers not exceeding 150 mm etc { Page NO. - 02 Item NO. - 4 (A) }	0.35	cum	599.61	206.87
3	Single Brick Flat Soling of picked jhama bricks including ramming and dressing bed to proper level and filling joints with local sand. { Page NO. - 14 Item NO. - 1 }	2.30	sqm	324.00	745.20
4	Cement concrete with graded Stone (30mm. Size excluding shuttering) In ground floor A) [Pakur Variety] 1:3:6 Page - 34, It. 22.	0.23	cum	5189	1,193.47
5	Ordinary Cement concrete (mix 1:1.5:3) with graded stone chips (20 mm nominal size) excluding shuttering and reinforcement if any, in ground floor as per relevant IS codes. (Panchami variety) { Page NO.- 26 Item NO. - 10 (iv) }	0.82	cum	6194.77	5,079.71
6	Reinforcement for reinforced concrete work in all sorts of structures including distribution bars, stirrups binders etc. including supply of rods, initial straightening and removal of loose rust (if necessary), cutting to requisite length, hooking and beneding to correct shape, placing in propret position and binding with 16 guage black annealed wire at every inter-section, complete as per drawing and direction. (a) for works in foundation, basement and upto roof of ground floor/upto 4m. (i) tor steel/mild steel. Page - 40 (a) (i) (i) II other than TATA /SAIL/RSNL	0.064	MT	64906.15	4,153.99
7	Plaster (to wall, floor, ceiling etc.) with sand and cement mortar including rounding off or (i) With 1:6 cement mortar (c) 15 mm thick plaster { Page: 189 Item NO. - 1 (ii) (c) }	3.50	Sqm	142.00	497.00
8	Neat cement punning about 1.5mm thick in wall, dado, window sill, floor etc. NOTE:Cement 0.152 cu.m per 100 sq.m. (Page - 192 Item - 15)	3.50	Sqm	34.00	119.00
9	Hire and labour charges for shuttering with centering and necessary staging upto 4 m and striking out after completion of works (upto roof of ground floor) (c) Steel shuttering or 9 to 12 mm. thick approved quality ply board shuttering in any concrete work. { Page NO.- 42 Item NO. - 36 (c) }	5.20	sqm	365.00	1,898.00

Rs. 14366.44

Add GST @ 12 % as applicable Rs. 1723.97

Sub total Rs. 16090.41

Add Labour welfare cess @ 1 % Rs. 160.90

Total Rs. 16251.31

Per Metr. Cost=
22.64 Mtr Drain=

Say Rs. 16251.00

Rs. 367923.00

Prepared By -

S. A. E.
Kandi Municipality
Kandi Municipality

Chairman
Kandi Municipality
CHAIRMAN
KANDI MUNICIPALITY

Construction Storm Water Drain at Non slum Ward No. 12

Length: 22.64 mtr.

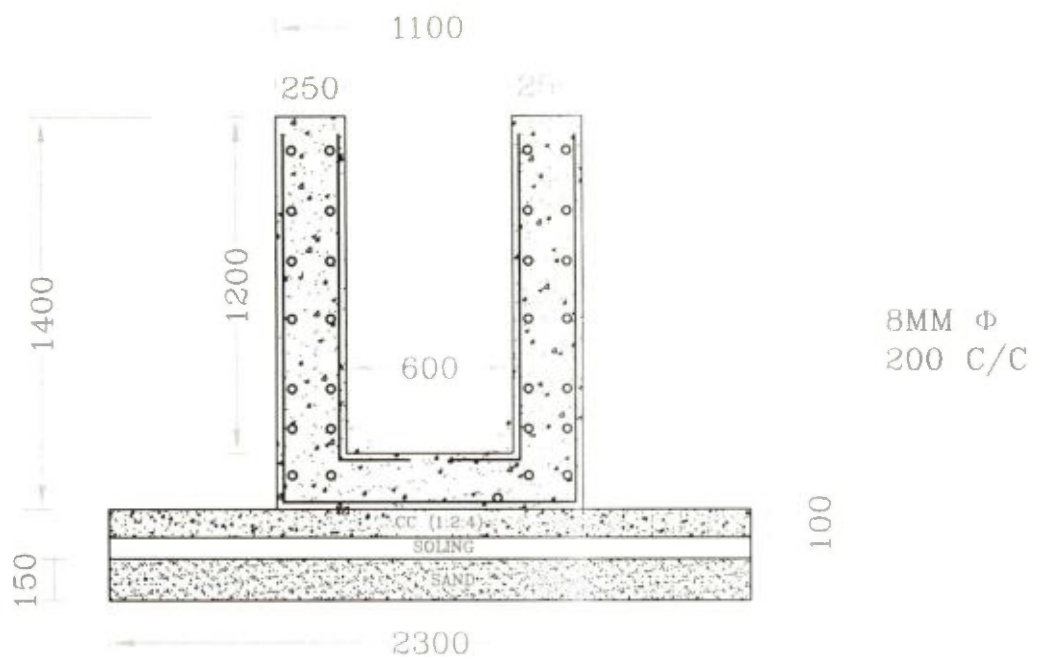

Drawn By:

Kandi Municipality

Chairman
Kandi Municipality

CHAIRMAN
KANDI MUNICIPALITY

Construction Storm Water Drain at Non Slum, at Ward No. 14

As per S. O. R. 2015 P. W. D. (Building) Schedule Effective From 01.11.2017 & 3rd CORRIGENDA & ADDENDA FOR SCHEDULE OF RATES OF PWD (W.B) wef 01.11.2017 Volume-I: (For Building Works, Materials & Labour)

Sl. NO.	Item	Quantity	unit	Rate Rs.	Amount Rs.
1	Earth work in excavation of foundation trenches or drains, in all sorts of soil (including mixed soil but excluding laterite or sandstone) including removing, spreading or stacking the spoils within a lead of 75 m.... complete. (a) Depth of excavation not exceeding 1,500 mm. { Page NO. - 01 Item NO. - 2 (a) }	3.97	Cum	119.27	473.20
2	Filling in foundation or plinth by silver sand in layers not exceeding 150 mm etc { Page NO. - 02 Item NO. - 4 (A) }	0.35	cum	599.61	206.87
3	Single Brick Flat Soling of picked jhama bricks including ramming and dressing bed to proper level and filling joints with local sand. { Page NO. - 14 Item NO. - 1 }	2.30	sqm	324.00	745.20
4	Cement concrete with graded Stone (30mm. Size excluding shuttering) In ground floor A) [Pakur Variety] 1:3:6 Page - 34, It. 22.	0.23	cum	5189	1,193.47
5	Ordinary Cement concrete (mix 1:1.5:3) with graded stone chips (20 mm nominal size) excluding shuttering and reinforcement if any, in ground floor as per relevant IS codes. (Panchami variety) { Page NO.- 26 Item NO. - 10 (iv) }	0.82	cum	6194.77	5,079.71
6	Reinforcement for reinforced concrete work in all sorts of structures including distribution bars, stirrups binders etc. including supply of rods, initial straightening and removal of loose rust (if necessary), cutting to requisite length, hooking and beneding to correct shape, placing in proper position and binding with 16 guage black annealed wire at every inter-section, complete as per drawing and direction. (a) for works in foundation, basement and upto roof of ground floor/upto 4m. (i) tor steel/mild steel. Page - 40 (a) (i) (i) II other than TATA /SAIL/RSNL	0.064	MT	64906.15	4,153.99
7	Plaster (to wall, floor, ceiling etc.) with sand and cement mortar including rounding off or (i) With 1:6 cement mortar (c) 15 mm thick plaster { Page: 189 Item NO. - 1 (ii) (c) }	3.50	Sqm	142.00	497.00
8	Neat cement punning about 1.5mm thick in wall, dado, window sill, floor etc. NOTE:Cement 0.152 cu.m per100 sq.m. (Page - 192 Item - 15)	3.50	Sqm	34.00	119.00
9	Hire and labour charges for shuttering with centering and necessary staging upto 4 m and striking out after completion of works (upto roof of ground floor) (c) Steel shuttering or 9 to 12 mm. thick approved quality ply board shuttering in any concrete work. { Page NO.- 42 Item NO. - 36 (c) }	5.20	sqm	365.00	1,898.00

Rs. 14366.44

Add GST @ 12 % as applicable Rs. 1723.97

Sub total Rs. 16090.41

Add Labour welfare cess @ 1 % Rs. 160.90

Total Rs. 16251.31

Per Metr. Cost=
27.17 Mtr Drain=

Say Rs. 16251.00

Rs. 441540.00

Prepared By -

S. A. E.
Kandi Municipality
SAE
Kandi Municipality

Chairman
Kandi Municipality
CHAIRMAN
KANDI MUNICIPALITY

Construction Storm Water Drain at Non slum
Ward No. 14

Length: 27.17 mtr.

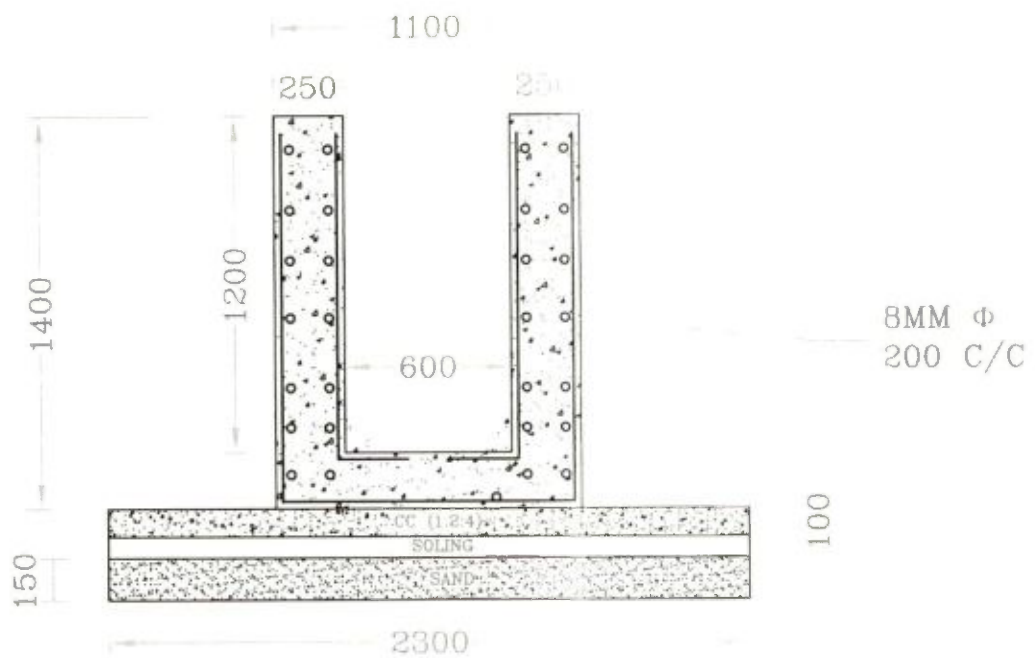

Drawn By:

Chairman
Kandi Municipality

CHAIRMAN
KANDI MUNICIPALITY

Construction Storm Water Drain at Non Slum, at Ward No. 15

As per S. O. R 2015 P. W. D (Building) Schedule Effective From 01.11.2017 & 3rd CORRIGENDA & ADDENDA FOR SCHEDULE OF RATES OF PWD (W.B) wef 01.11.2017 Volume-I: (For Building Works, Materials & Labour)

SL NO.	Item	Quantity	unit	Rate Rs.	Amount Rs.
1	Earth work in excavation of foundation trenches or drains, in all sorts of soil (including mixed soil but excluding laterite or sandstone) including removing, spreading or stacking the spoils within a lead of 75 m.... complete. (a) Depth of excavation not exceeding 1,500 mm. { Page NO. - 01 Item NO. - 2 (a) }	3.97	Cum	119.27	473.20
2	Filling in foundation or plinth by silver sand in layers not exceeding 150 mm etc { Page NO. - 02 Item NO. - 4 (A) }	0.35	cum	599.61	206.87
3	Single Brick Flat Soling of picked jhama bricks including ramming and dressing bed to proper level and filling joints with local sand. { Page NO. - 14 Item NO. - 1 }	2.30	sqm	324.00	745.20
4	Cement concrete with graded Stone (30mm. Size excluding shuttering) In ground floor A) [Pakur Variety] 1:3:6 Page - 34, It. 22.	0.23	cum	5189	1,193.47
5	Ordinary Cement concrete (mix 1:1.5:3) with graded stone chips (20 mm nominal size) excluding shuttering and reinforcement if any, in ground floor as per relevant IS codes. (Panchami variety) { Page NO.- 26 Item NO. - 10 (iv) }	0.82	cum	6194.77	5,079.71
6	Reinforcement for reinforced concrete work in all sorts of structures including distribution bars, stirrups binders etc. including supply of rods, initial straightening and removal of loose rust (if necessary), cutting to requisite length, hooking and beneding to correct shape, placing in propret position and binding with 16 guage black annealed wire at every inter-section, complete as per drawing and direction. (a) for works in foundation, basement and upto roof of ground floor/upto 4m. (i) tor steel/mild steel. Page - 40 (a) (i) (i) II other than TATA /SAIL/RSNL	0.064	MT	64906.15	4,153.99
7	Plaster (to wall, floor, ceiling etc.) with sand and cement mortar including rounding off or (i) With 1:6 cement mortar (c) 15 mm thick plaster { Page: 189 Item NO. - 1 (ii) (c) }	3.50	Sqm	142.00	497.00
8	Neat cement punning about 1.5mm thick in wall, dado, window sill, floor etc. NOTE:Cement 0.152 cu.m per 100 sq.m. (Page - 192 Item - 15)	3.50	Sqm	34.00	119.00
9	Hire and labour charges for shuttering with centering and necessary staging upto 4 m and striking out after completion of works (upto roof of ground floor) (e) Steel shuttering of 9 to 12 mm. thick approved quality ply board shuttering in any concrete work. { Page NO.- 42 Item NO. - 36 (c) }	5.20	sqm	365.00	1,898.00

Rs. 14366.44

Add GST @ 12 % as applicable Rs. 1723.97

Sub total Rs. 16090.41

Add Labour welfare cess @ 1 % Rs. 160.90

Total Rs. 16251.31

Per Metr. Cost=
43.03 Mtr Drain=

Say Rs. 16251.00

Rs. 699281.00

Prepared By -

S. A. E.
Kandi Municipality
SAE
Kandi Municipality

Chairman
Kandi Municipality
KANDI MUNICIPALITY

Construction Storm Water Drain at Non slum
Ward No. 15
Length: 43.03 mtr.

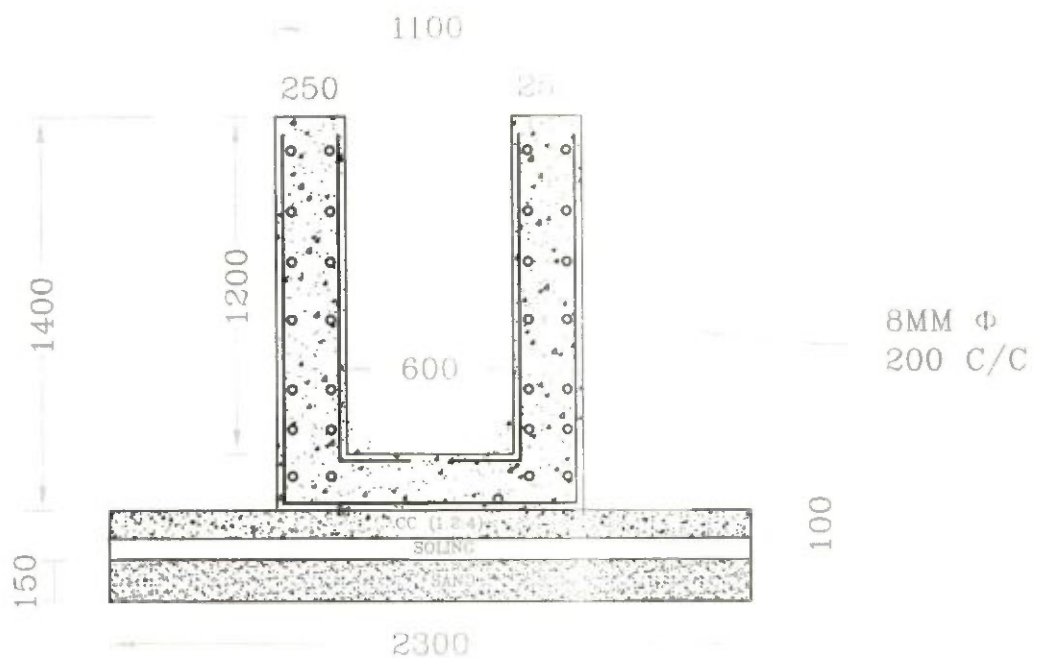

Drawn By:

Kandi Municipality

Chairman
Kandi Municipality

CHAIRMAN
KANDI MUNICIPALITY

Construction Storm Water Drain at Non Slum, at Ward No. 16

As per S. O. R 2015 P. W. D (Building) Schedule Effective From 01.11.2017 & 3rd CORRIGENDA & ADDENDA FOR SCHEDULE OF RATES OF PWD (W.B) wef 01.11.2017 Volume-I: (For Building Works, Materials & Labour)

Sl. NO.	Item	Quantity	unit	Rate Rs.	Amount Rs.
1	Earth work in excavation of foundation trenches or drains, in all sorts of soil (including mixed soil but excluding laterite or sandstone) including removing, spreading or stacking the spoils within a lead of 75 m.... complete. (a) Depth of excavation not exceeding 1,500 mm. { Page NO. - 01 Item NO. - 2 (a) }	3.97	Cum	119.27	473.20
2	Filling in foundation or plinth by silver sand in layers not exceeding 150 mm etc { Page NO. - 02 Item NO. - 4 (A) }	0.35	cum	599.61	206.87
3	Single Brick Flat Soling of picked jhama bricks including ramming and dressing bed to proper level and filling joints with local sand. { Page NO. - 14 Item NO. - 1 }	2.30	sqm	324.00	745.20
4	Cement concrete with graded Stone (30mm. Size excluding shuttering) In ground floor A) [Pakur Variety] 1:3:6 Page - 34, It. 22.	0.23	cum	5189	1,193.47
5	Ordinary Cement concrete (mix 1:1.5:3) with graded stone chips (20 mm nominal size) excluding shuttering and reinforcement if any, in ground floor as per relevant IS codes. (Panchami variety) { Page NO.- 26 Item NO. - 10 (iv) }	0.82	cum	6194.77	5,079.71
6	Reinforcement for reinforced concrete work in all sorts of structures including distribution bars, stirrups binders etc. including supply of rods, initial straightening and removal of loose rust (if necessary), cutting to requisite length, hooking and beneding to correct shape, placing in propert position and binding with 16 guage black annealed wire at every inter-section, complete as per drawing and direction. (a) for works in foundation, basement and upto roof of ground floor/upto 4m. (i) tor steel/mild steel. Page - 40 (a) (i) (i) II other than TATA /SAIL/RSNL.	0.064	MT	64906.15	4,153.99
7	Plaster (to wall, floor, ceiling etc.) with sand and cement mortar including rounding off or (i) With 1:6 cement mortar (c) 15 mm thick plaster { Page: 189 Item NO. - 1(ii) (c) }	3.50	Sqm	142.00	497.00
8	Neat cement punning about 1.5mm thick in wall, dado, window sill, floor etc. NOTE:Cement 0.152 cu.m per 100 sq.m. (Page - 192 Item - 15)	3.50	Sqm	34.00	119.00
9	Hire and labour charges for shuttering with centering and necessary staging upto 4 m and striking out after completion of works (upto roof of ground floor) (c) Steel shuttering or 9 to 12 mm. thick approved quality ply board shuttering in any concrete work. { Page NO.- 42 Item NO. - 36 (c) }	5.20	sqm	365.00	1,898.00

Rs. 14366.44

Add GST @ 12 % as applicable Rs. 1723.97

Sub total Rs. 16090.41

Add Labour welfare cess @ 1 % Rs. 160.90

Total Rs. 16251.31

Per Metr. Cost=
33.97 Mtr Drain=

Say Rs. 16251.00

Rs. 552046.00

Prepared By -

S. A. E.
Kandi Municipality
SAE
Kandi Municipality

Chairman
Kandi Municipality
CHAIRMAN
KANDI MUNICIPALITY

Construction Storm Water Drain at Non slum
Ward No. 16

Length: 33.97 mtr.

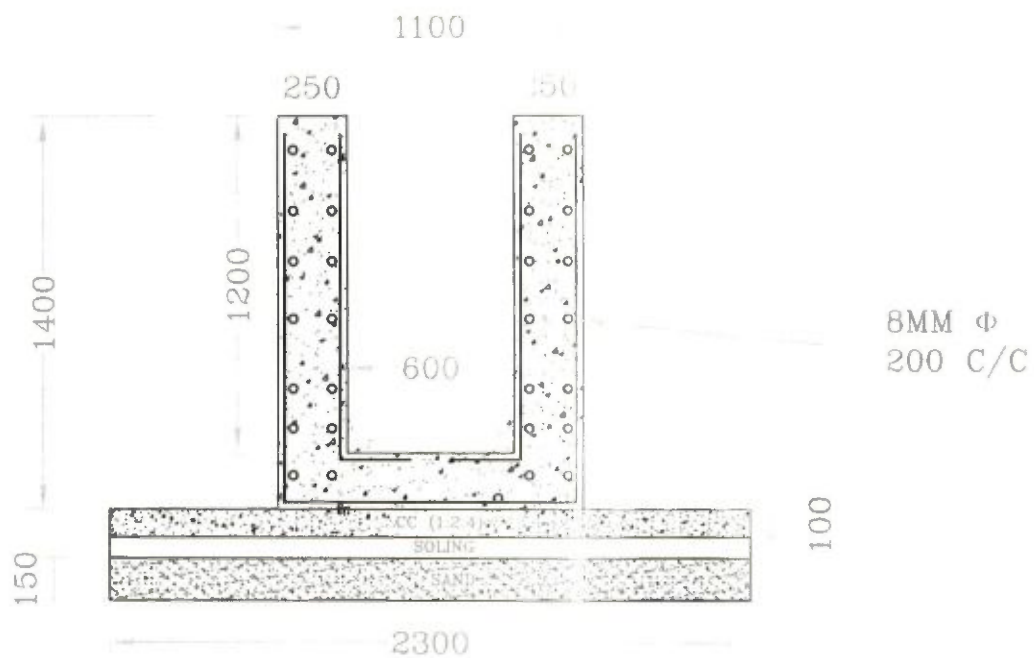

Drawn By:

Kandi Municipality

Chairman
Kandi Municipality

CHAIRMAN
KANDI MUNICIPALITY

Construction Storm Water Drain at Non Slum, at Ward No. 17

As per S. O. R 2015 P. W. D (Building) Schedule Effective From 01.11.2017 & 3rd CORRIGENDA & ADDENDA FOR SCHEDULE OF RATES OF PWD (W.B) wef 01.11.2017 Volume-I: (For Building Works, Materials & Labour)

Sl. NO.	Item	Quantity	unit	Rate Rs.	Amount Rs.
1	Earth work in excavation of foundation trenches or drains, in all sorts of soil (including mixed soil but excluding laterite or sandstone) including removing, spreading or stacking the spoils within a lead of 75 m.... complete. (a) Depth of excavation not exceeding 1,500 mm. { Page NO. - 01 Item NO. - 2 (a) }	3.97	Cum	119.27	473.20
2	Filling in foundation or plinth by silver sand in layers not exceeding 150 mm etc { Page NO. - 02 Item NO. - 4 (A) }	0.35	cum	599.61	206.87
3	Single Brick Flat Soling of picked jhama bricks including ramming and dressing bed to proper level and filling joints with local sand. { Page NO. - 14 Item NO. - 1 }	2.30	sqm	324.00	745.20
4	Cement concrete with graded Stone (30mm. Size excluding shuttering) In ground floor A) [Pakur Variety] 1:3:6 Page - 34, It. 22.	0.23	cum	5189	1,193.47
5	Ordinary Cement concrete (mix 1:1.5:3) with graded stone chips (20 mm nominal size) excluding shuttering and reinforcement if any, in ground floor as per relevant IS codes. (Panchami variety) { Page NO.- 26 Item NO. - 10 (iv) }	0.82	cum	6194.77	5,079.71
6	Reinforcement for reinforced concrete work in all sorts of structures including distribution bars, stirrups binders etc. including supply of rods, initial straightening and removal of loose rust (if necessary), cutting to requisite length, hooking and beneding to correct shape, placing in propret position and binding with 16 guage black annealed wire at every inter-section, complete as per drawing and direction. (a) for works in foundation, basement and upto roof of ground floor/upto 4m. (i) tor steel/mild steel. Page - 40 (a) (i) (i) II other than TATA /SAIL/RSNL	0.064	MT	64906.15	4,153.99
7	Plaster (to wall, floor, ceiling etc.) with sand and cement mortar including rounding off or (i) With 1:6 cement mortar (c) 15 mm thick plaster { Page: 189 Item NO. - 1 (ii) (c) }	3.50	Sqm	142.00	497.00
8	Neat cement punning about 1.5mm thick in wall, dado, window sill, floor etc. NOTE:Cement 0.152 cu.m per100 sq.m. (Page - 192 Item - 15)	3.50	Sqm	34.00	119.00
9	Hire and labour charges for shuttering with centering and necessary staging upto 4 m and striking out after completion of works (upto roof of ground floor) (c) Steel shuttering or 9 to 12 mm. thick approved quality ply board shuttering in any concrete work. { Page NO.- 42 Item NO. - 36 (c) }	5.20	sqm	365.00	1,898.00

Rs. 14366.44

Add GST @ 12 % as applicable Rs. 1723.97

Sub total Rs. 16090.41

Add Labour welfare cess @ 1 % Rs. 160.90

Total Rs. 16251.31

Per Metr. Cost=
15.85 Mtr Drain=

Say Rs. 16251.00

Rs. 257578.00

Prepared By -

S. A. E.
Kandi Municipality
SAE

Kandi Municipality

[Signature]
Chairman

Kandi Municipality
CHAIRMAN
KANDI MUNICIPALITY

Construction Storm Water Drain at Non slum Ward No. 17

Length: 15.85 mtr.

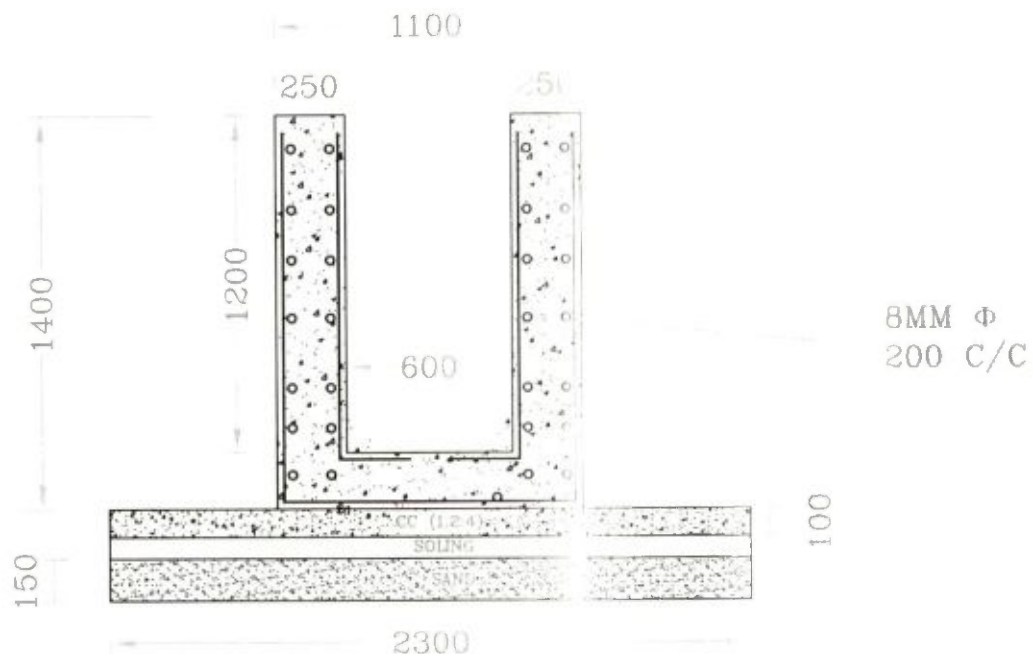

Drawn By:

Kandi Municipality

Chairman
Kandi Municipality

CHAIRMAN
KANDI MUNICIPALITY

Construction Storm Water Drain at Non Slum, at Ward No. 18

As per S. O. R 2015 P. W. D (Building) Schedule Effective From 01.11.2017 & 3rd CORRIGENDA & ADDENDA FOR SCHEDULE OF RATES OF PWD (W.B) wef 01.11.2017 Volume-I: (For Building Works, Materials & Labour)

Sl NO.	Item	Quantity	unit	Rate Rs.	Amount Rs.
1	Earth work in excavation of foundation trenches or drains, in all sorts of soil (including mixed soil but excluding laterite or sandstone) including removing, spreading or stacking the spoils within a lead of 75 m.... complete. (a) Depth of excavation not exceeding 1,500 mm. { Page NO. - 01 Item NO. - 2 (a) }	3.97	Cum	119.27	473.20
2	Filling in foundation or plinth by silver sand in layers not exceeding 150 mm etc { Page NO. - 02 Item NO. - 4 (A) }	0.35	cum	599.61	206.87
3	Single Brick Flat Soling of picked jhama bricks including ramming and dressing bed to proper level and filling joints with local sand. { Page NO. - 14 Item NO. - 1 }	2.30	sqm	324.00	745.20
4	Cement concrete with graded Stone (30mm. Size excluding shuttering) In ground floor A) [Pakur Variety] 1:3:6 Page - 34, It. 22.	0.23	cum	5189	1,193.47
5	Ordinary Cement concrete (mix 1:1.5:3) with graded stone chips (20 mm nominal size) excluding shuttering and reinforcement if any, in ground floor as per relevant IS codes. (Panchami variety) { Page NO.- 26 Item NO. - 10 (iv) }	0.82	cum	6194.77	5,079.71
6	Reinforcement for reinforced concrete work in all sorts of structures including distribution bars, stirrups binders etc. including supply of rods, initial straightening and removal of loose rust (if necessary), cutting to requisite length, hooking and beneding to correct shape, placing in propret position and binding with 16 guage black annealed wire at every inter-section, complete as per drawing and direction. (a) for works in foundation, basement and upto roof of ground floor/upto 4m. (i) tor steel/mild steel. Page - 40 (a) (i) (i) II other than TATA /SAIL/RSNL	0.064	MT	64906.15	4,153.99
7	Plaster (to wall, floor, ceiling etc.) with sand and cement mortar including rounding off or (i) With 1:6 cement mortar (c) 15 mm thick plaster { Page: 189 Item NO. - 1(ii) (c) }	3.50	Sqm	142.00	497.00
8	Neat cement punning about 1.5mm thick in wall, dado, window sill, floor etc. NOTE:Cement 0.152 cu.m per 100 sq.m. (Page - 192 Item - 15)	3.50	Sqm	34.00	119.00
9	Hire and labour charges for shuttering with centering and necessary staging upto 4 m and striking out after completion of works (upto roof of ground floor) (c) Steel shuttering or 9 to 12 mm. thick approved quality ply board shuttering in any concrete work. { Page NO. = 42 Item NO. = 36 (e) }	5.20	sqm	365.00	1,898.00

Rs. 14366.44

Add GST @ 12 % as applicable Rs. 1723.97

Sub total Rs. 16090.41

Add Labour welfare cess @ 1 % Rs. 160.90

Total Rs. 16251.31

Per Metr. Cost=
40.76 Mtr Drain=

Say Rs. 16251.00

Rs. 662391.00

Prepared By -

S. A. E.
Kandi Municipality
SAE
Kandi Municipality

Chairman
Kandi Municipality
CHAIRMAN
KANDI MUNICIPALITY

Construction Storm Water Drain at Non slum Ward No. 18

Length: 40.76 mtr.

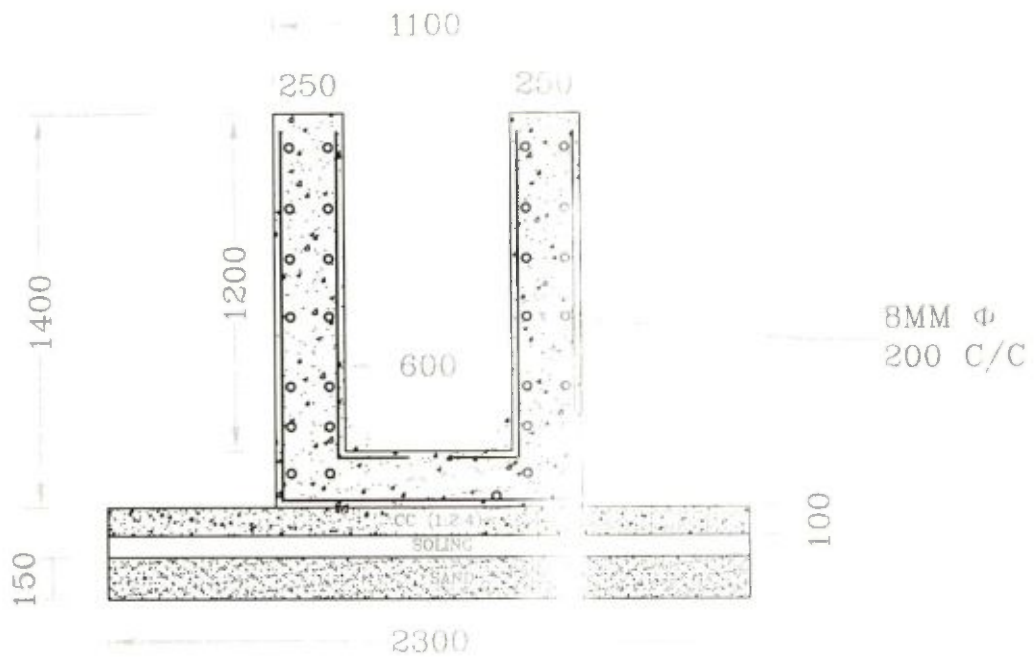

Drawn By:

SAB
Kandi Municipality

Chairman
Kandi Municipality

CHAIRMAN
KANDI MUNICIPALITY

SL. NO	Ward no (Instead of Non-slum name)	DWELLING UNIT	DRAIN (In Meter)		
1	1	15	32.98	16739	552052.2
2	2	14	30.78	16739	515226.4
3	3	5	10.99	16739	183961.6
4	4	18	39.57	16739	662362.2
5	5	5	10.99	16739	183961.6
6	6	5	10.99	16739	183961.6
7	7	22	48.37	16739	809665.4
8	8	0	0.00	16739	0
9	9	14	30.78	16739	515226.4
10	10	0	0.00	16739	0
11	11	12	26.38	16739	441574.8
12	12	10	21.98	16739	367923.2
13	13	0	0.00	16739	0
14	14	12	26.38	16739	441574.8
15	15	19	41.77	16739	699188
16	16	15	32.99	16739	552219.6
17	17	7	15.39	16739	257600
18	18	18	39.57	16739	662362.2
TOTAL=		191	419.91		

CHAIRMAN
KANDI MUNICIPALITY



SLUM & NON SLUM MAP



KANDI MUNICIPALITY
MOHAN BAGAN EAST SLUM NO - SC - 001
WARD NO - 01



LEGEND :-

-  PROPOSED DRAIN (26.38M)
-  EXISTING HOUSE HOLD
-  PROPOSED HFA (12 nos)

SL. NO. 01

S. A. S.
Kandi Municipality

CHAIRMAN
KANDI MUNICIPALITY

SL. NO. 02

KANDI MUNICIPLITY HAJRA PARA SLUM SC - 002 WARD - 01

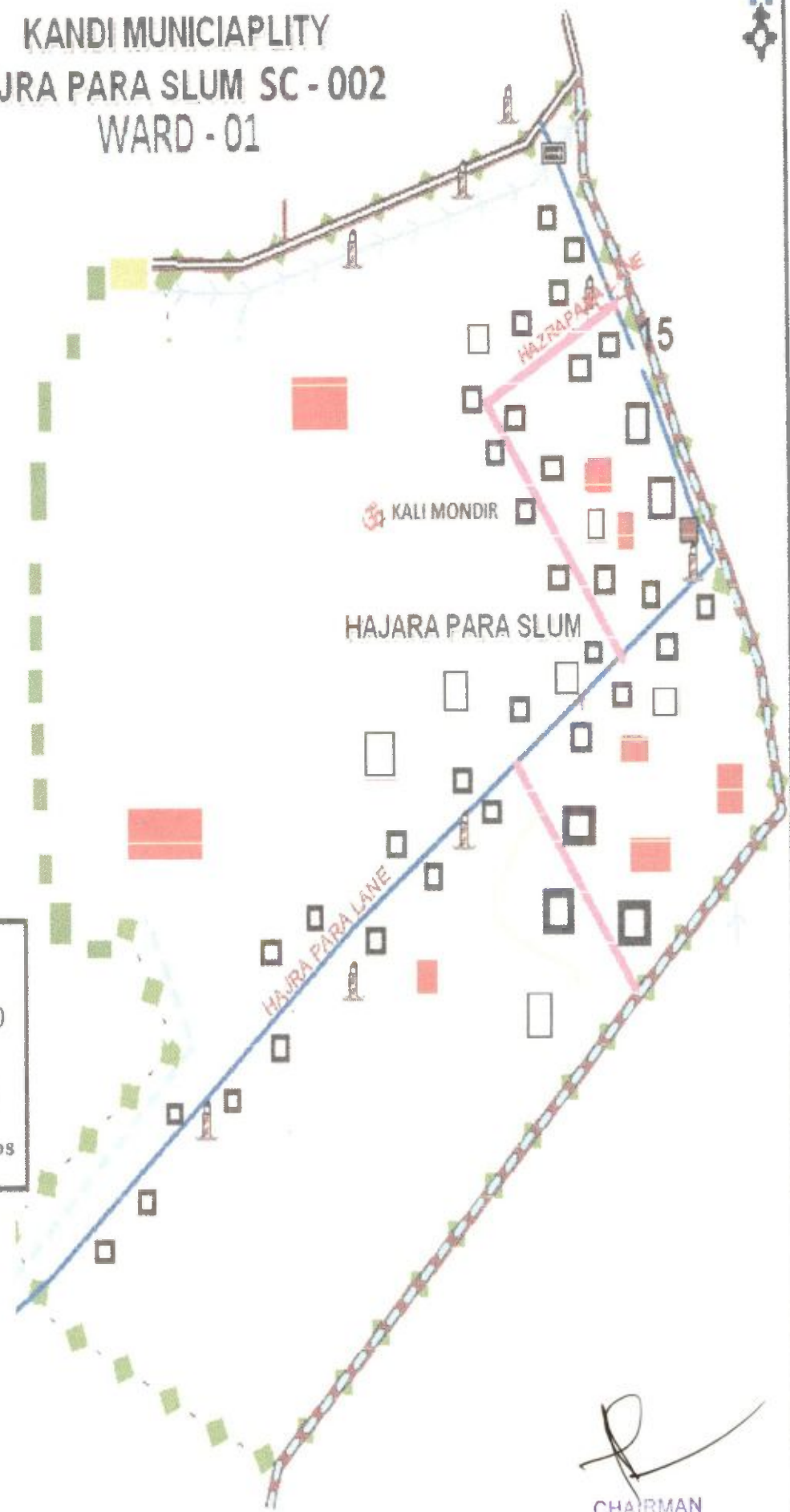

LEGEND :-

- PROPOSED DRAIN (17.58 M)
- EXISTING HOUSE HOLD
- PROPOSED HOUSE HOLD 8 NOS

S. A. E.
Kandi Municipality



CHAIRMAN
KANDI MUNICIPALITY

S. A. E.
Kandi Municipality

KANDI MUNICIPLITY

MOHAN BAGAN WEST SLUM NO - SC - 044

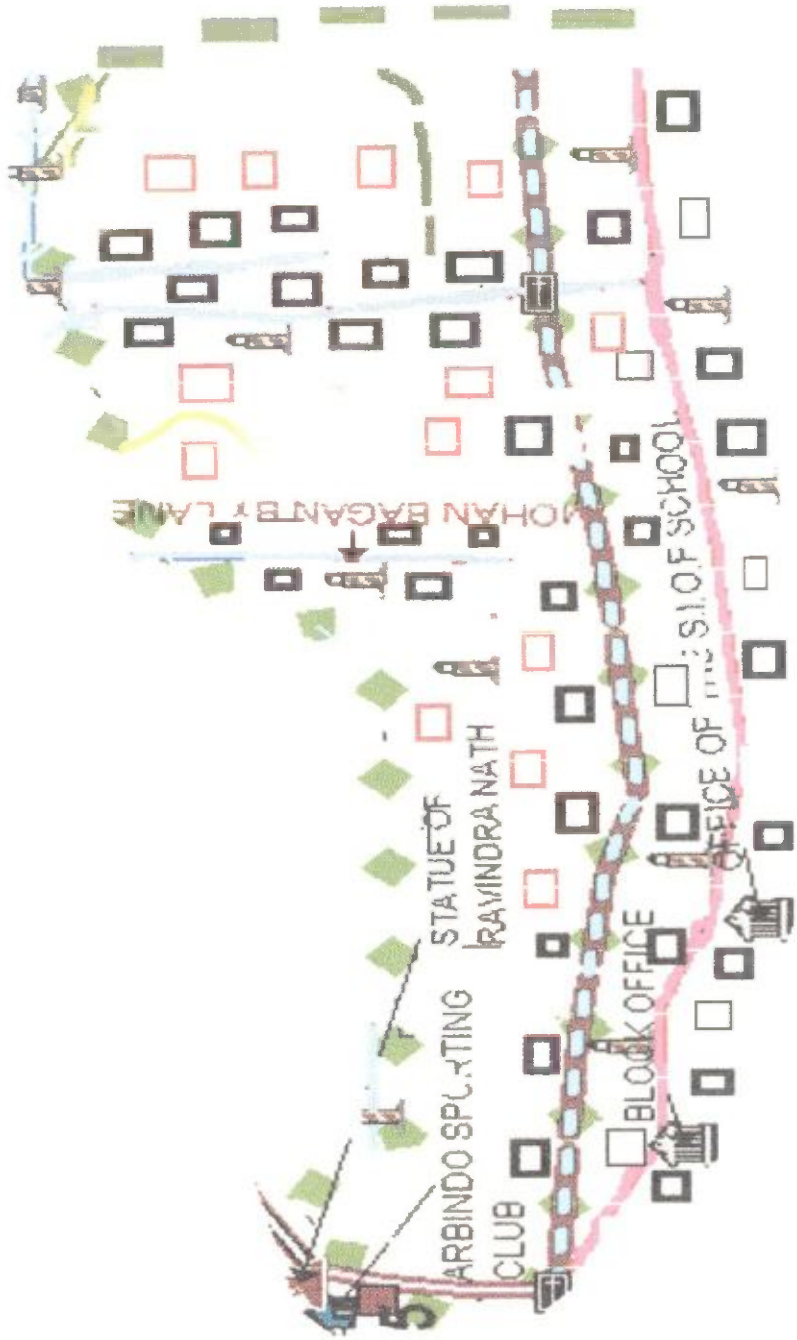
WARD NO - 01



LEGEND :-

PROPOSED DRAIN 26.38 M

EXISTING HOUSE HOLD

PROPOSED HFA (12 NOS)

CHAIRMAN
KANDI MUNICIPALITY



KANDI MUNICIPLITY

Kala bagan sirish tala slum NO-SC-004

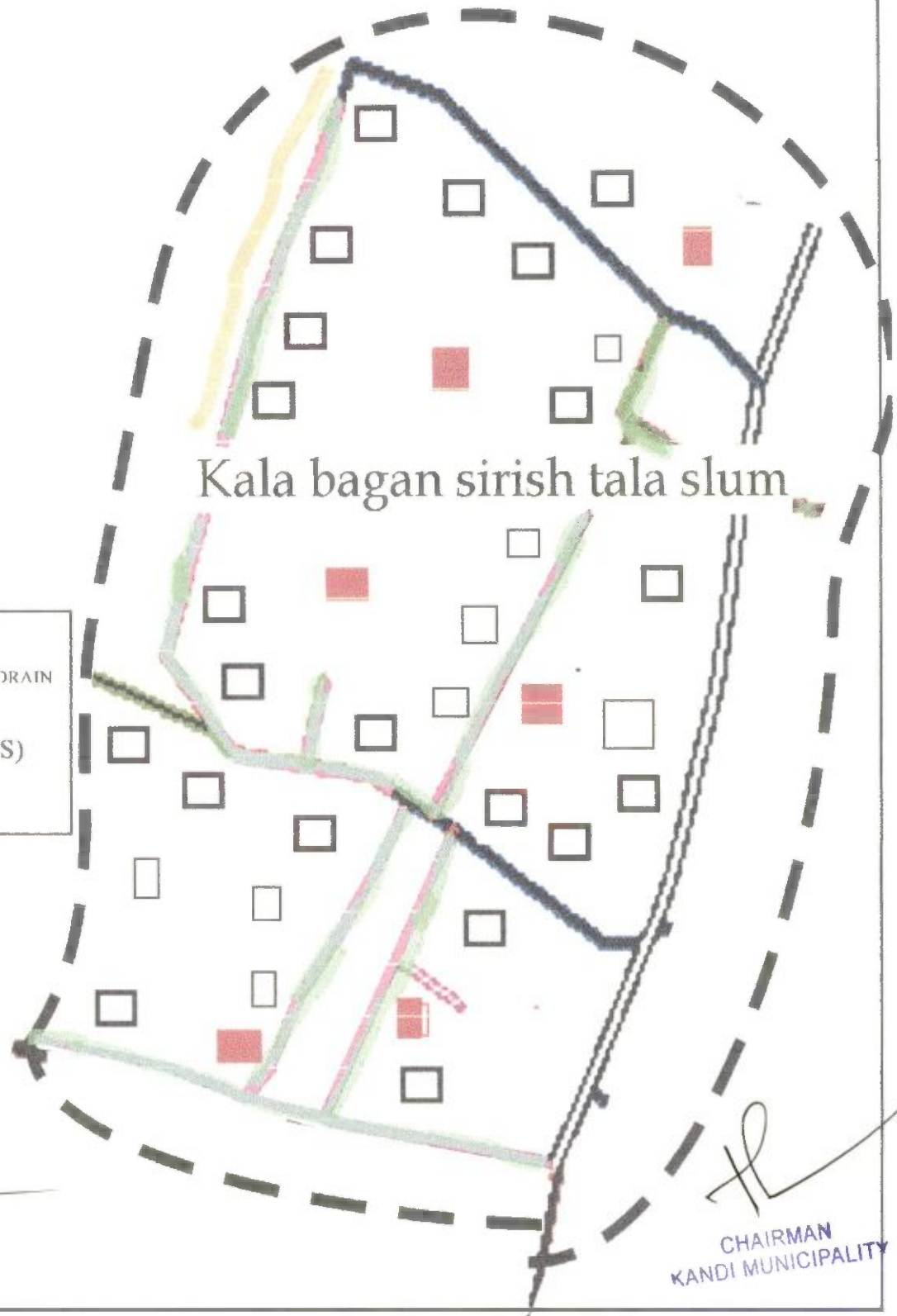
Ward no - 02



LEGEND :-

-  PROPOSED BRICK DRAIN
63.28 M
-  EXISTING HOUSE HOLD
-  PROPOSED HFA (6 NOS)

S. A. E.
Kandi Municipality

CHAIRMAN
KANDI MUNICIPALITY



KANDI MUNICIPLITY

BOLTALA SLUM SC - 005

WARD NO - 03



LEGEND :-

-  PROPOSED DRAIN (0.99 m)
-  EXISTING HOUSE HOLD
-  PROPOSED HFA (5 NOS)

[Signature]
S.A. E.
Kandi Municipality

[Signature]
CHAIRMAN
KANDI MUNICIPALITY



KANDI MUNICIPLITY

Taramatala slum sc - 045

Ward no - 03



LEGEND :-

-  PROPOSED BRICK DRAIN
42.19 M
-  EXISTING HOUSE HOLD
-  PROPOSED HFA (4 NOS)

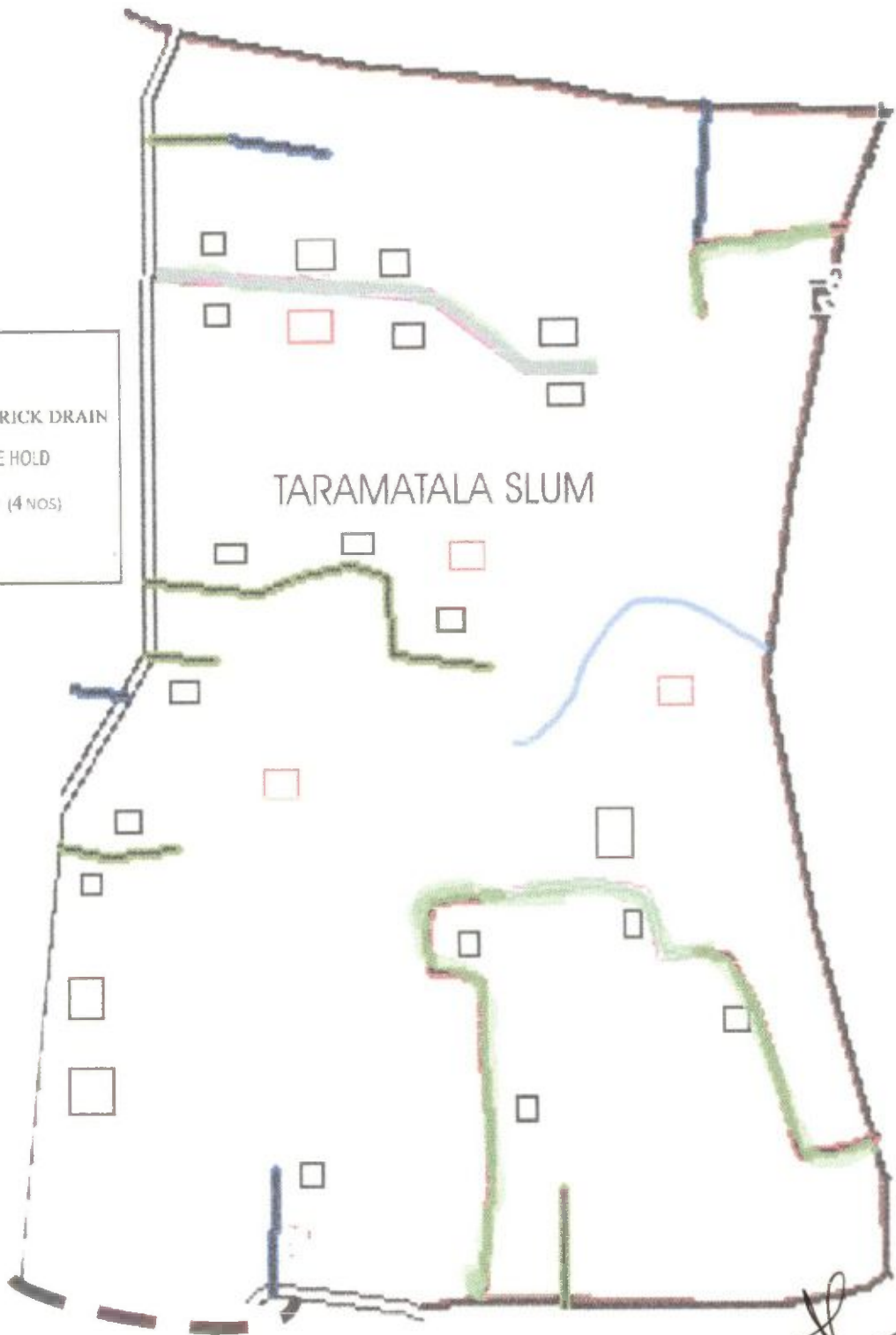

Kandi Municipality

CHAIRMAN
KANDI MUNICIPALITY

SL.NO 08

KANDI MUNICIPLITY

Kurupara slum SC-046

Ward no - 03

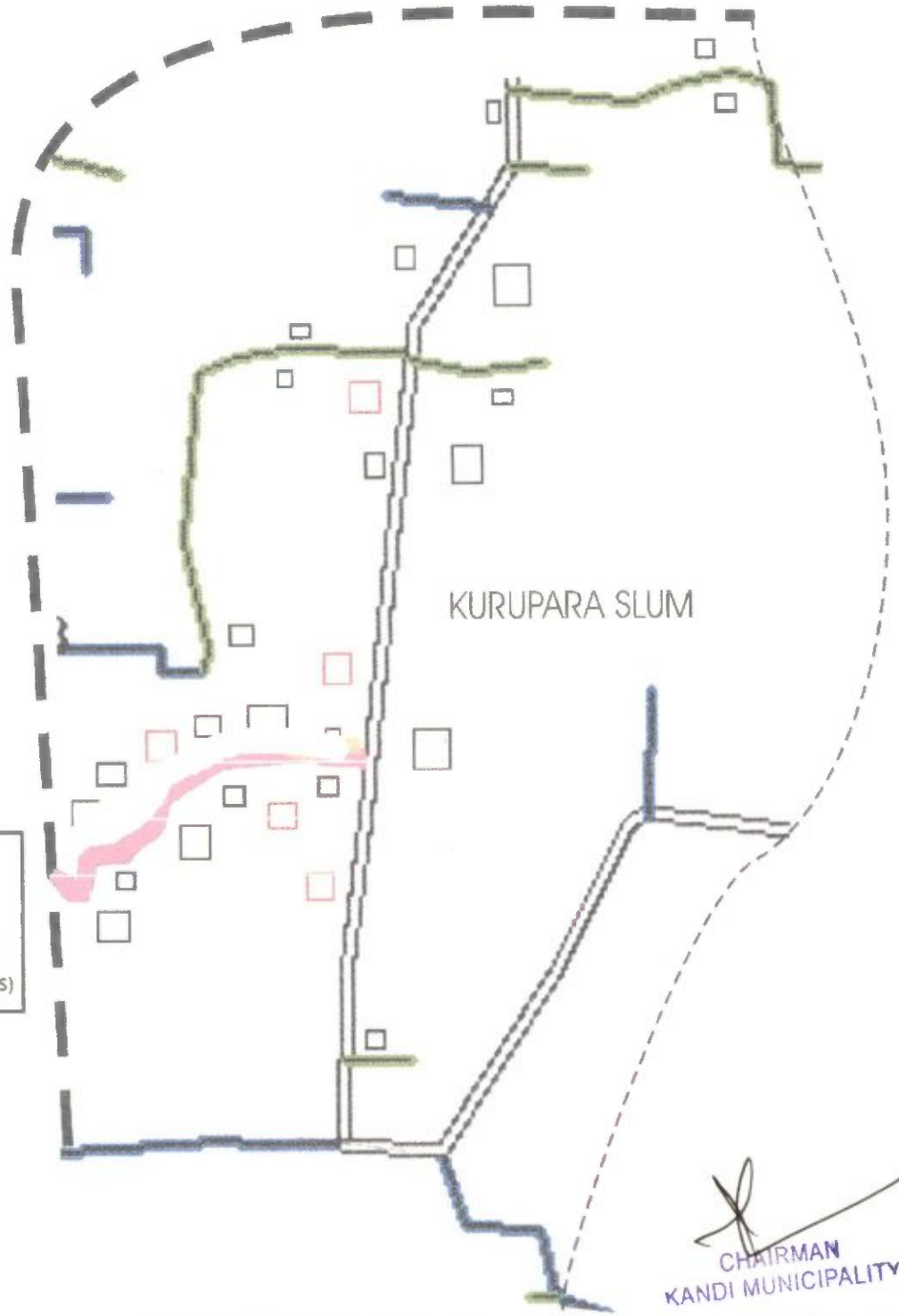

LEGEND :-
[Pink line] PROPOSED BRICK DRAIN 52.74 M
[Black square] EXISTING HOUSE HOLD
[Red square] PROPOSED HFA (5 NOS)

CHAIRMAN
KANDI MUNICIPALITY

S. A. E.
Kandi Municipality



KANDI MUNICIPALITY
NAMO KANDI DOM PARA (MUSLIM PARA) (SC - 006)

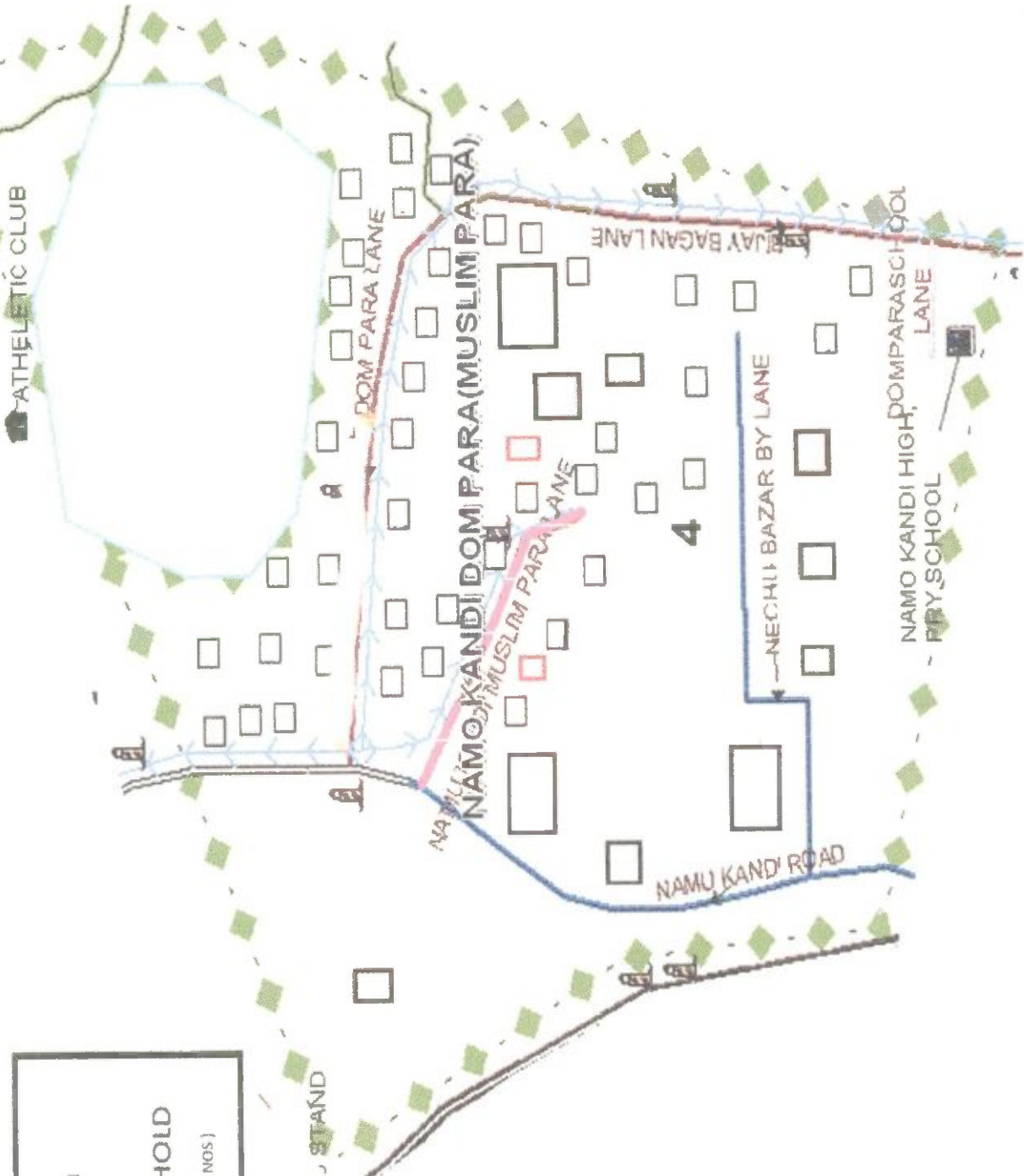

LEGEND :-

-  PROPOSED BRICK DRAIN 21.98 M
-  EXISTING HOUSE HOLD
-  PROPOSED HFA (2 NOS)

SL NO. 09

S. A. E.
 Kandi Municipality

[Signature]
 CHAIRMAN
 KANDI MUNICIPALITY

KANDI MUNICIPLITY

Molla para ramsinghpar slum (SC - 007)

Ward no - 04



LEGEND :-

-  PROPOSED BRICK DRAIN 31.64 M
-  EXISTING HOUSE HOLD
-  PROPOSED HFAI (3 NOS)

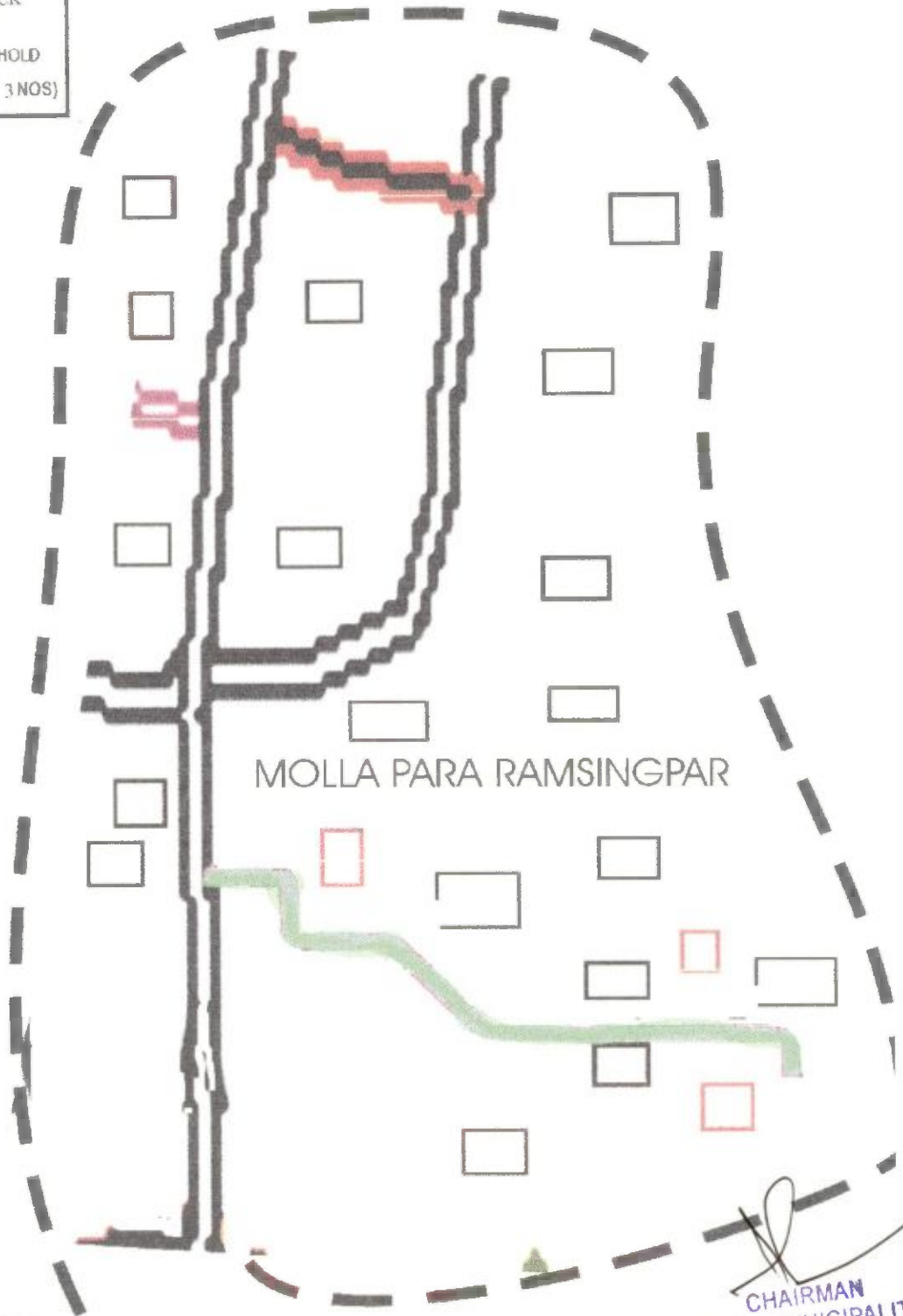

S.A.E.
Kandi Municipality



CHAIRMAN
KANDI MUNICIPALITY

KANDI MUNICIPLITY

Gopinathpur Konaipara sc - 008

Ward no-04

LEGEND :-

-  EXISTING HOUSE HOLD
-  PROPOSED HFA (2 NOS)

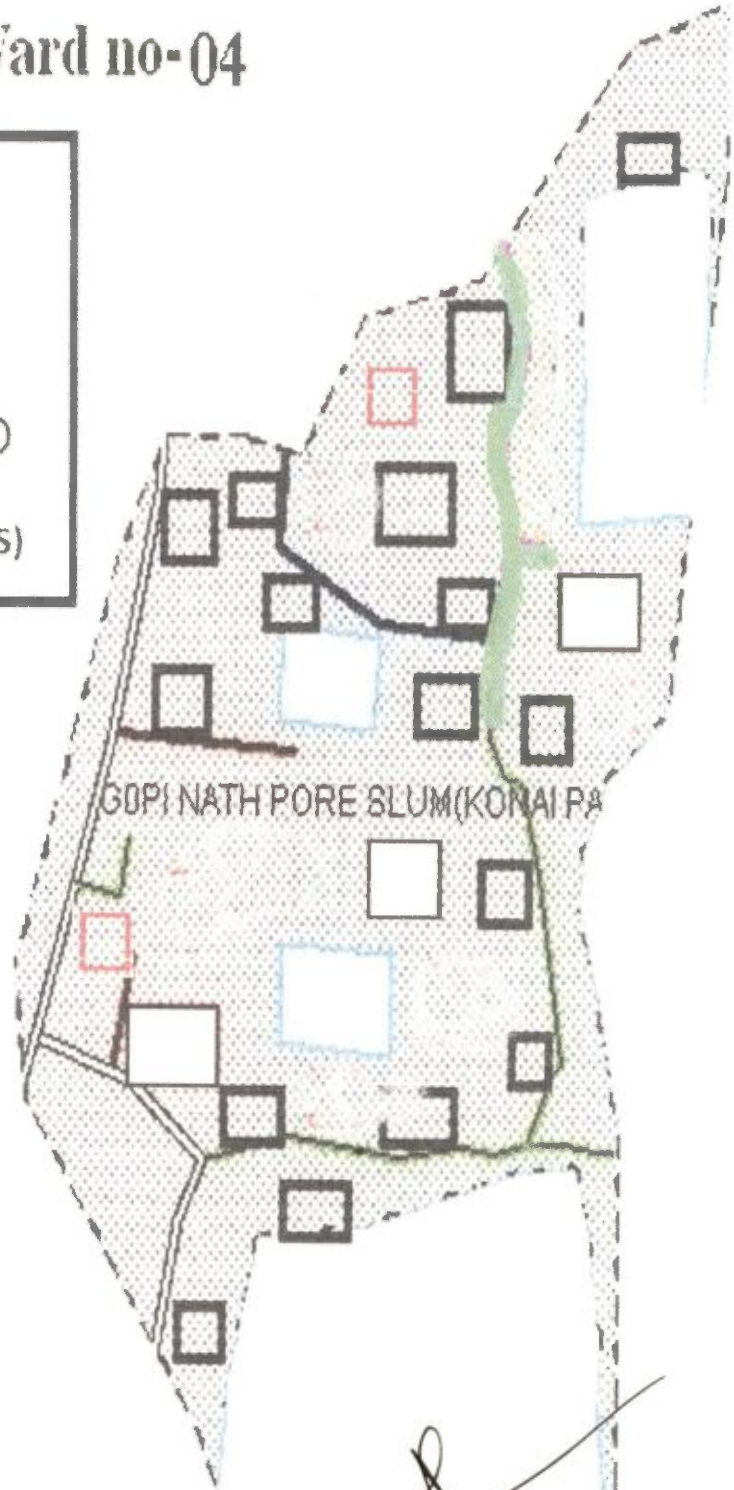

GOPINATH PORE SLUM (KONAI PARE)

S. A. E.
Kandi Municipality

CHAIRMAN
KANDI MUNICIPALITY

KANDI MUNICIAPLITY

Gopinathpur Konaipara sc - 008

Ward no-04

LEGEND :-

 PROPOSED BRICK DRAIN 21.09 M

 EXISTING HOUSE HOLD

 PROPOSED HFA (2 NOS)

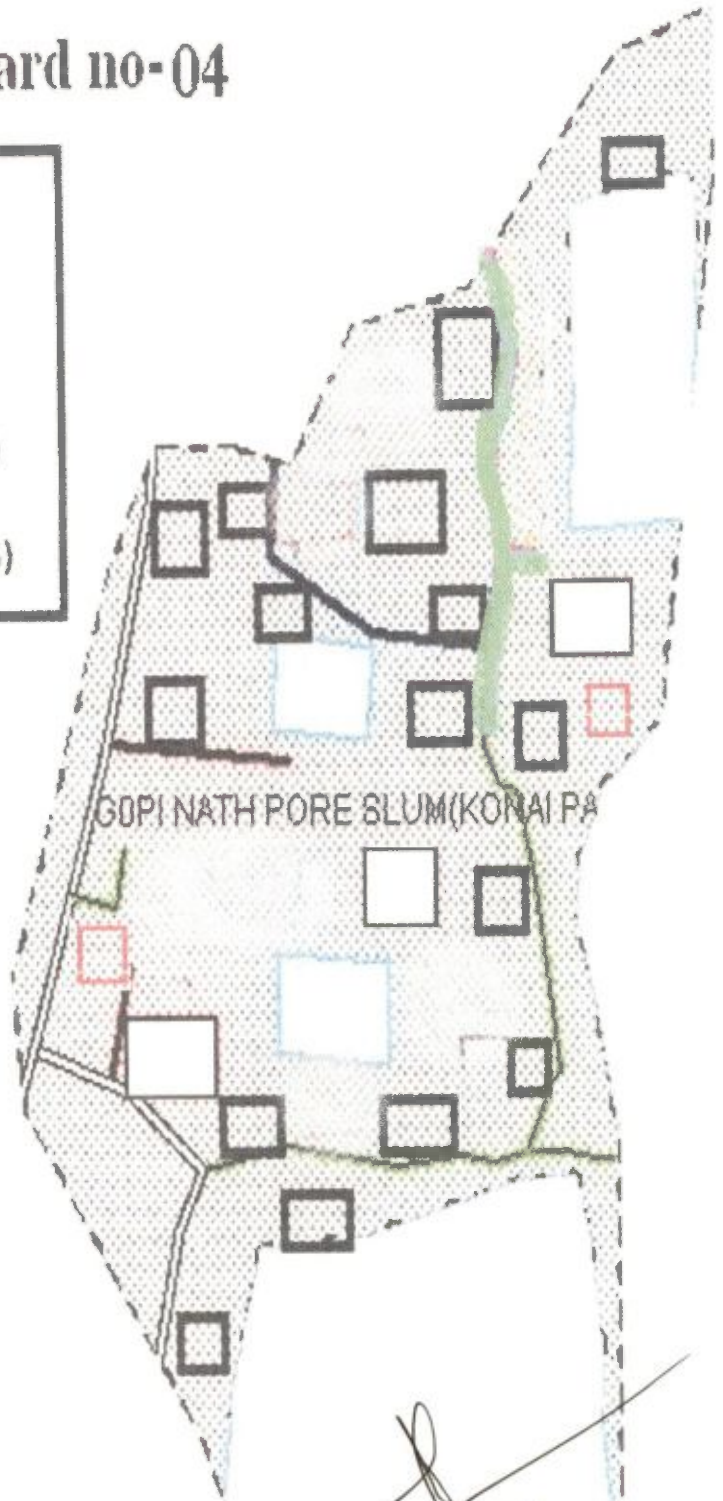

S. A. E.
Kandi Municipality

CHAIRMAN
KANDI MUNICIPALITY



KANDI MUNICIPLITY

Ghosh para slum (SC - 047)

Ward no - 04



LEGEND :-

-  PROPOSED DRAIN (17.59 M)
-  EXISTING HOUSE HOLD
-  PROPOSED HFA (8 NOS)

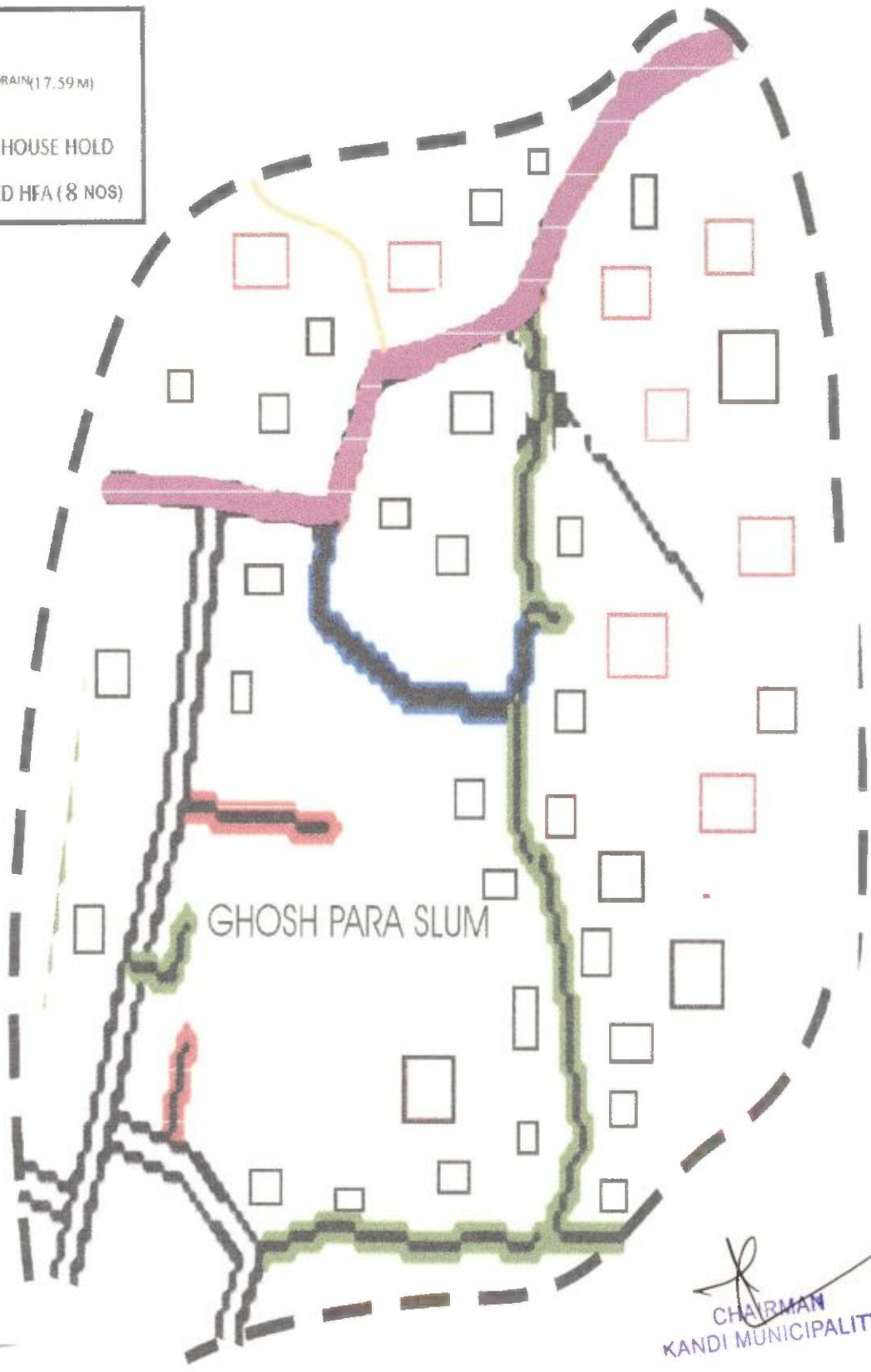

CHAIRMAN
KANDI MUNICIPALITY

S. A. E.
Kandi Municipality

SL. NO. 13

S. A. E.
Kandi Municipality

KANDI MUNICIPALITY

PURATAN HAT BAGAN PARA SLUM SC - 009

WORD - 05

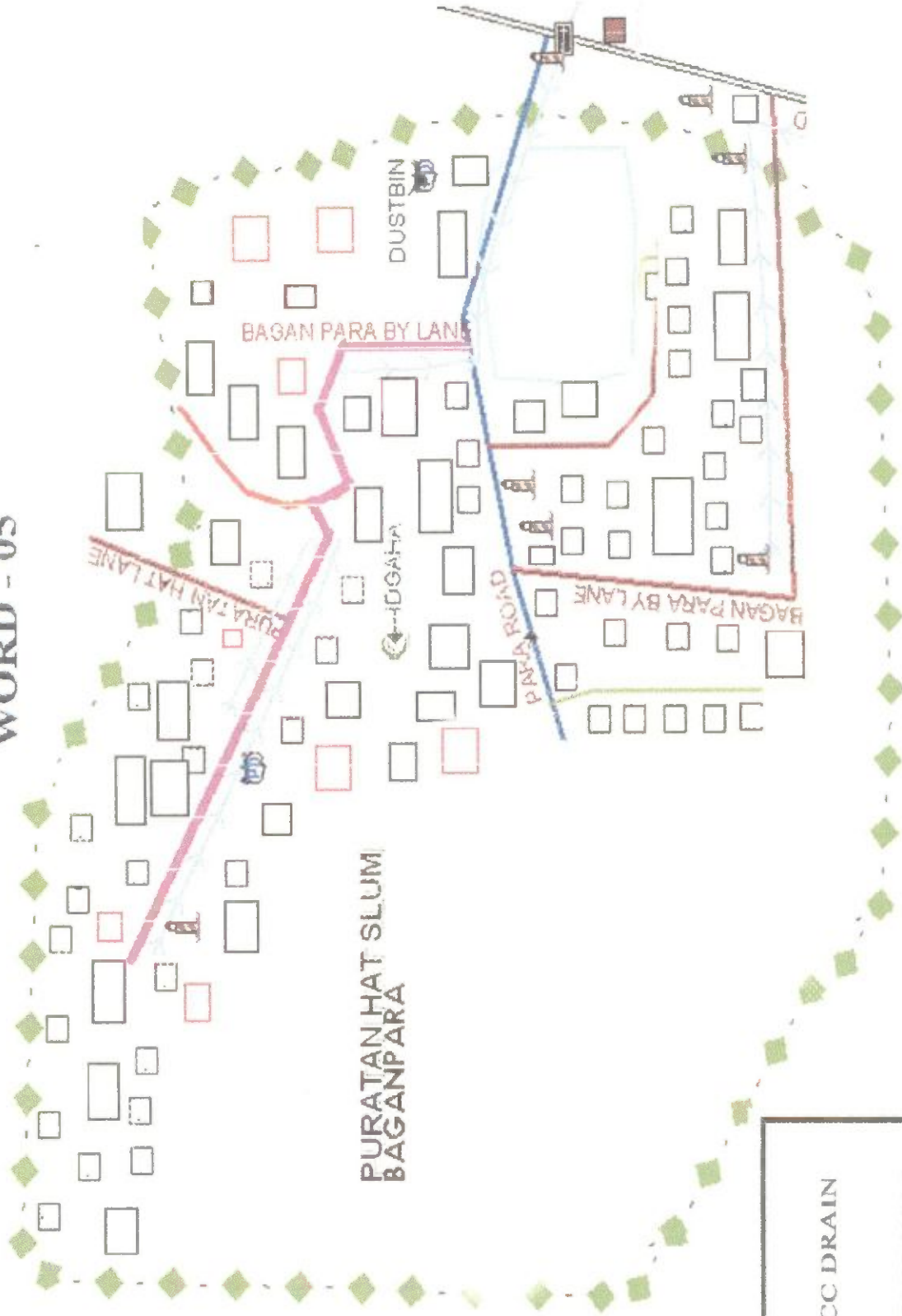

PURATAN HAT SLUM
BAGAN PARA

DUSTBIN

BAGAN PARA BY LANE

PURATAN HAT LANE

PARA ROAD

DUSTBIN

[Signature]
CHAIRMAN
KANDI MUNICIPALITY

LEGEND :-

-  PROPOSED CC DRAIN
17.59 M
-  EXISTING HOUSE HOLD
-  PROPOSED HFA (8'x10')



KANDI MUNICIPALITY
MOHONBAGAN PARA SC - 048
WARD NO - 05

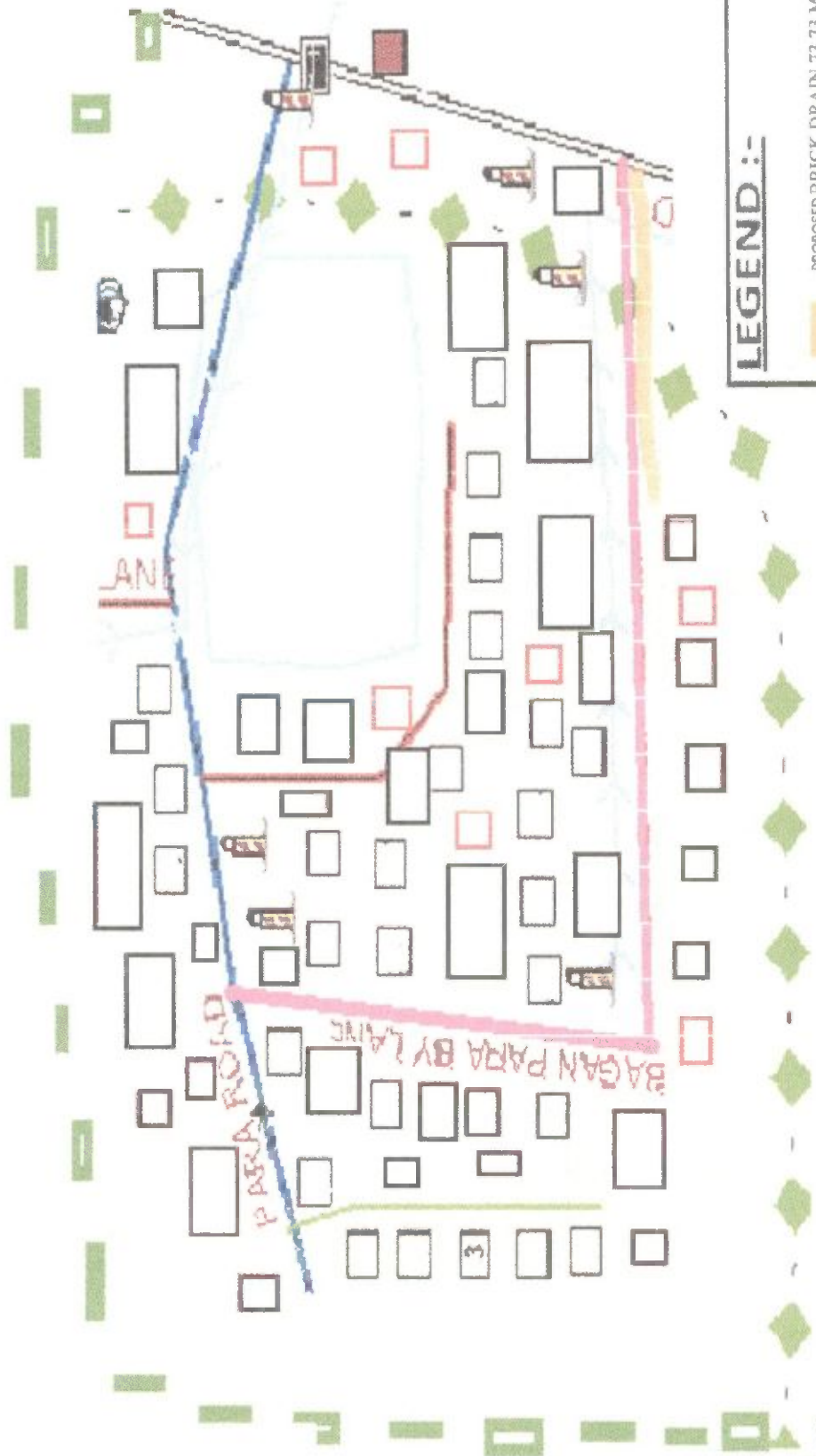

LEGEND :-

- PROPOSED BRICK DRAIN 73.73 M
- EXISTING HOUSE HOLD
- PROPOSED HFA. (7Nos)

SL. NO. 14

S.A.E.
Kandi Municipality

CHAIRMAN
KANDI MUNICIPALITY

KANDI MUNICIPLITY

Rajar dighir par slum SC -010

Ward no - 06



LEGEND :-

- PROPOSED DRAIN (59.36 M)
- EXISTING HOUSE HOLD
- PROPOSED HFA 27 nos

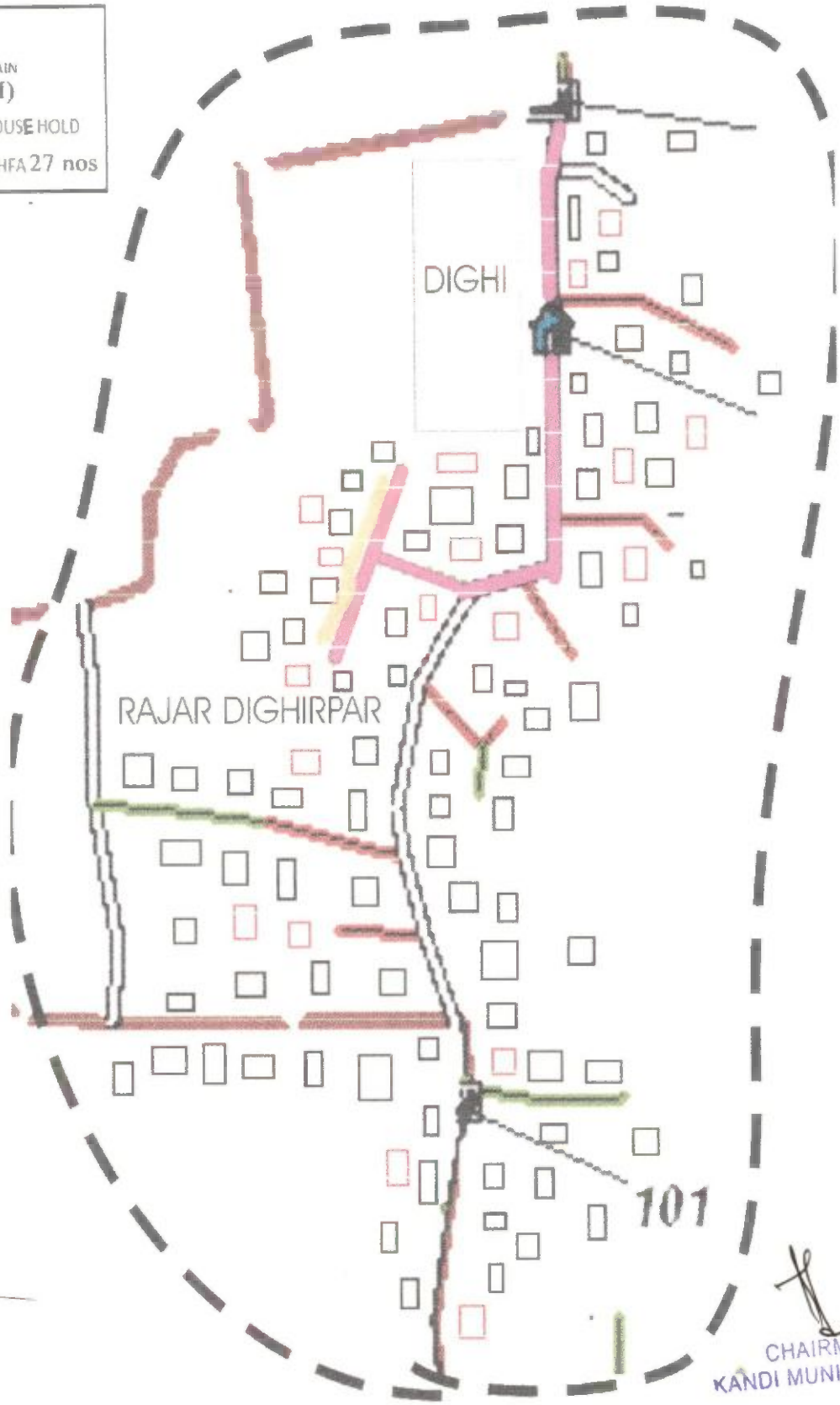

S. A. E.
Kandi Municipality

CHAIRMAN
KANDI MUNICIPALITY





KANDI MUNICIPALITY
CHUKU PARA SLUM (SC - 011)
WORD NO - 06

SL. NO 16

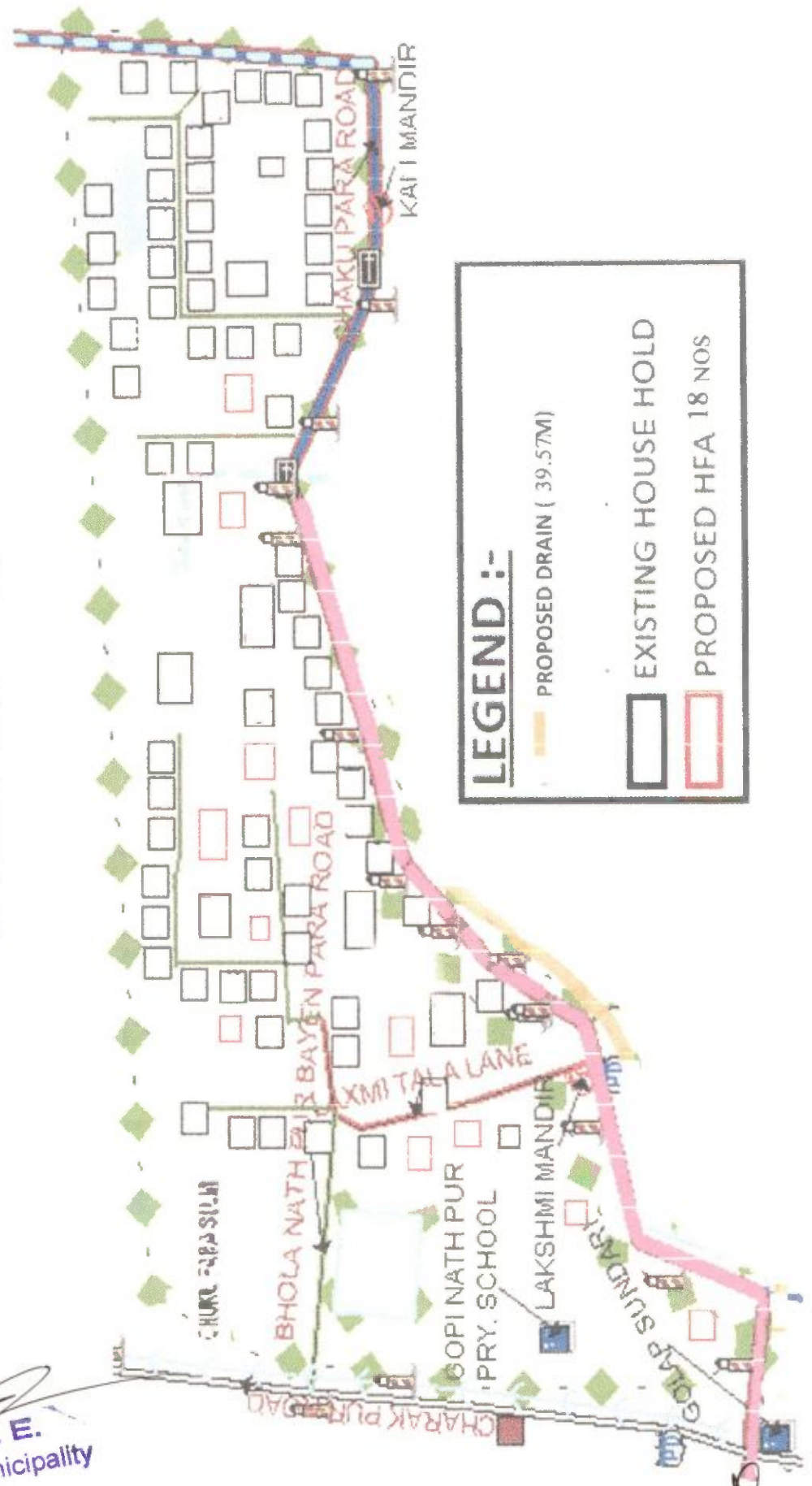
S. A. E.
 Kandi Municipality



LEGEND :-

-  PROPOSED DRAIN (39.57M)
-  EXISTING HOUSE HOLD
-  PROPOSED HFA 18 NOS

CHAIRMAN
 KANDI MUNICIPALITY



KANDI MUNICIPLITY
Adirapara Chhatinakandi (SC - 012)
Ward no- 06

LEGEND :-

-  PROPOSED CC ROAD
267.46
-  EXISTING HOUSE HOLD
-  PROPOSED HFA (39 NOS)

S. A. E.
Kandi Municipality

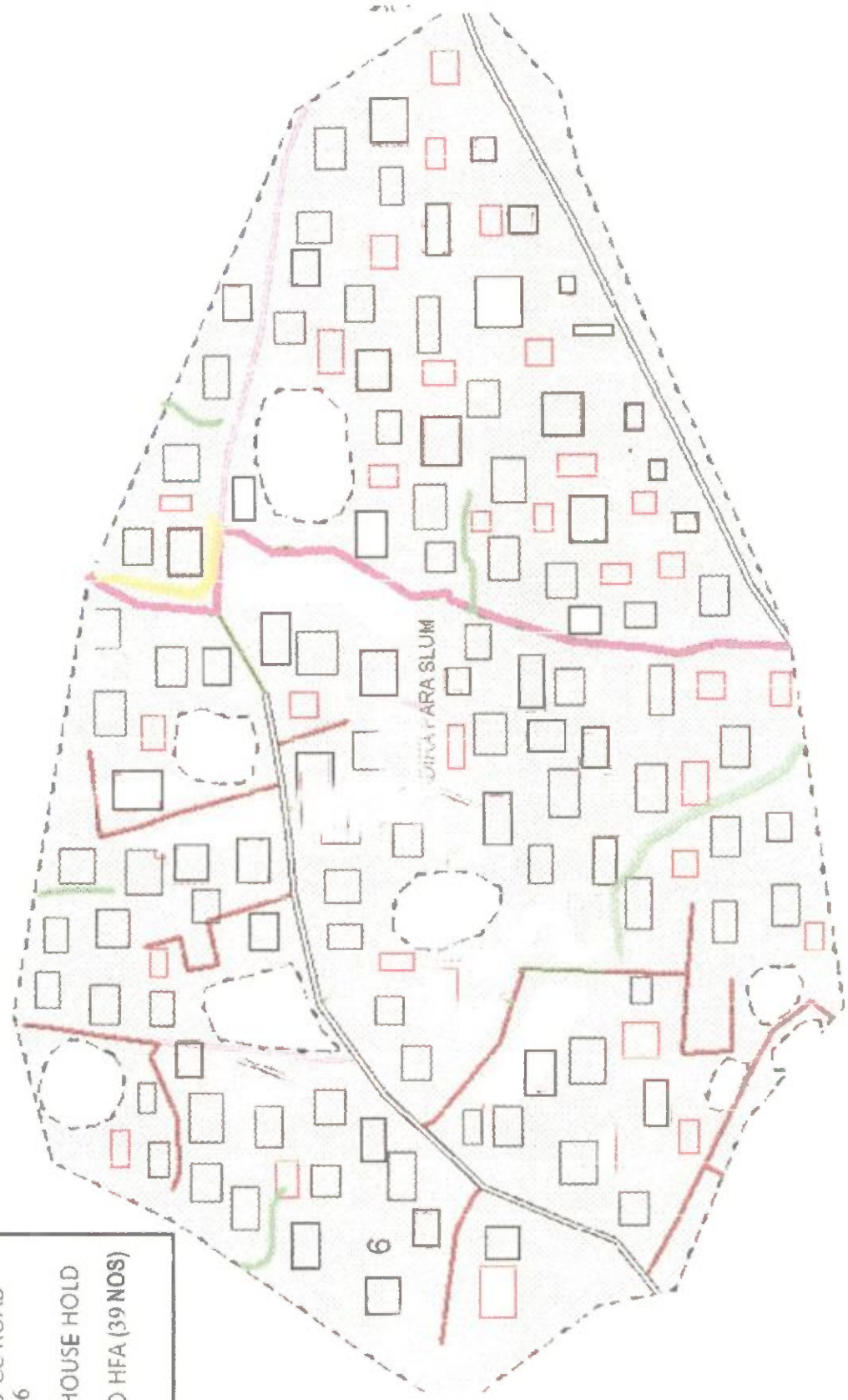



CHAIRMAN
KANDI MUNICIPALITY

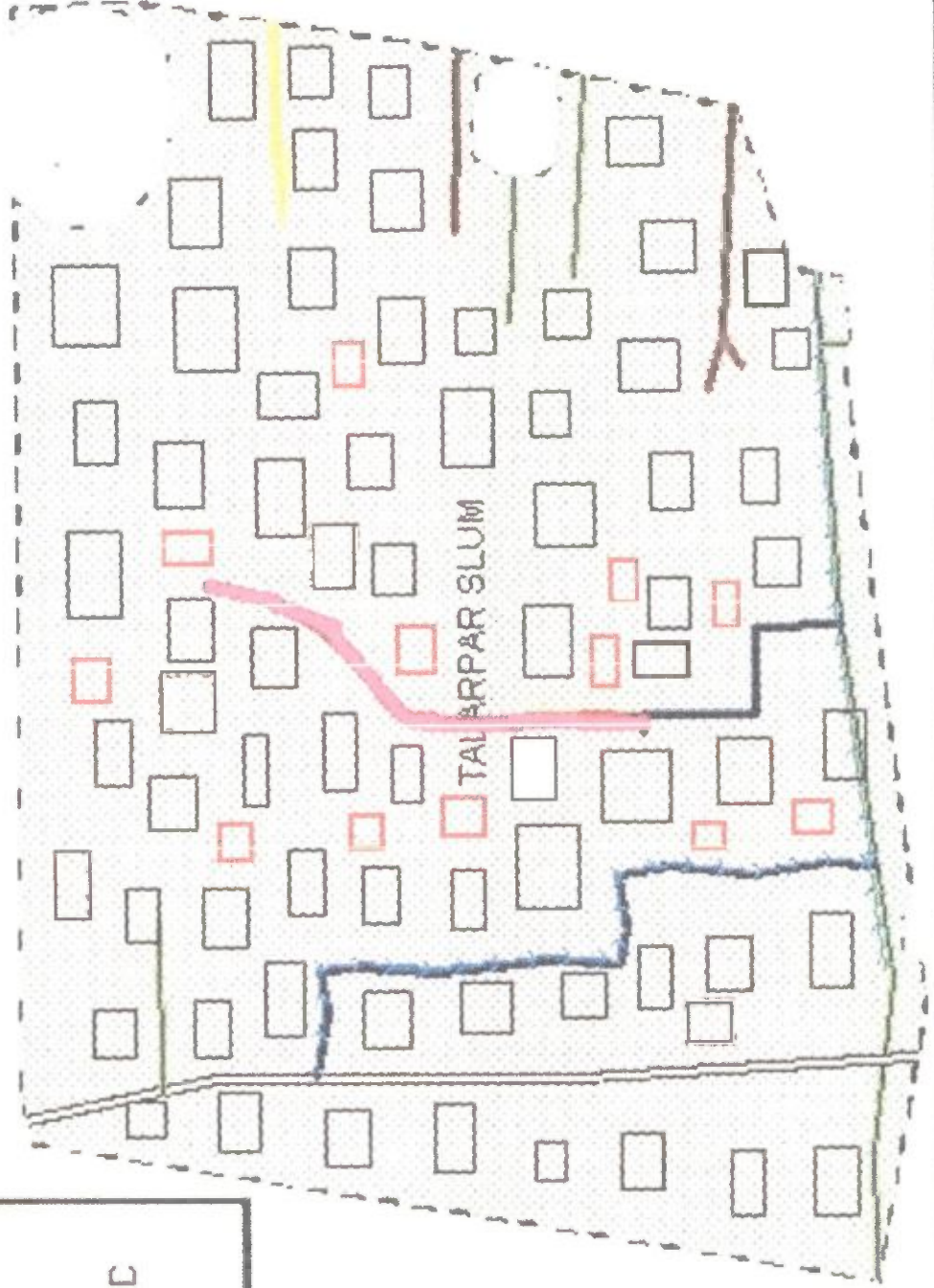

KANDI MUNICIPALITY
Talarpar Slum (SC - 13)

Ward no- 06



SL.NO. 18

S. A. E.
Kandi Municipality

LEGEND :-

— PROPOSED DRAIN (26.38M)

□ EXISTING HOUSE HOLD

□ PROPOSED HFA (12 NOS)

CHAIRMAN
KANDI MUNICIPALITY

KANDI MUNICIPLITY

RASORAH BAGDI PARA SLUM (SC - 014) WORD NO. - 07





LEGEND :-

 PROPOSED CC ROAD (137.16 M

 EXISTING HOUSE HOLD

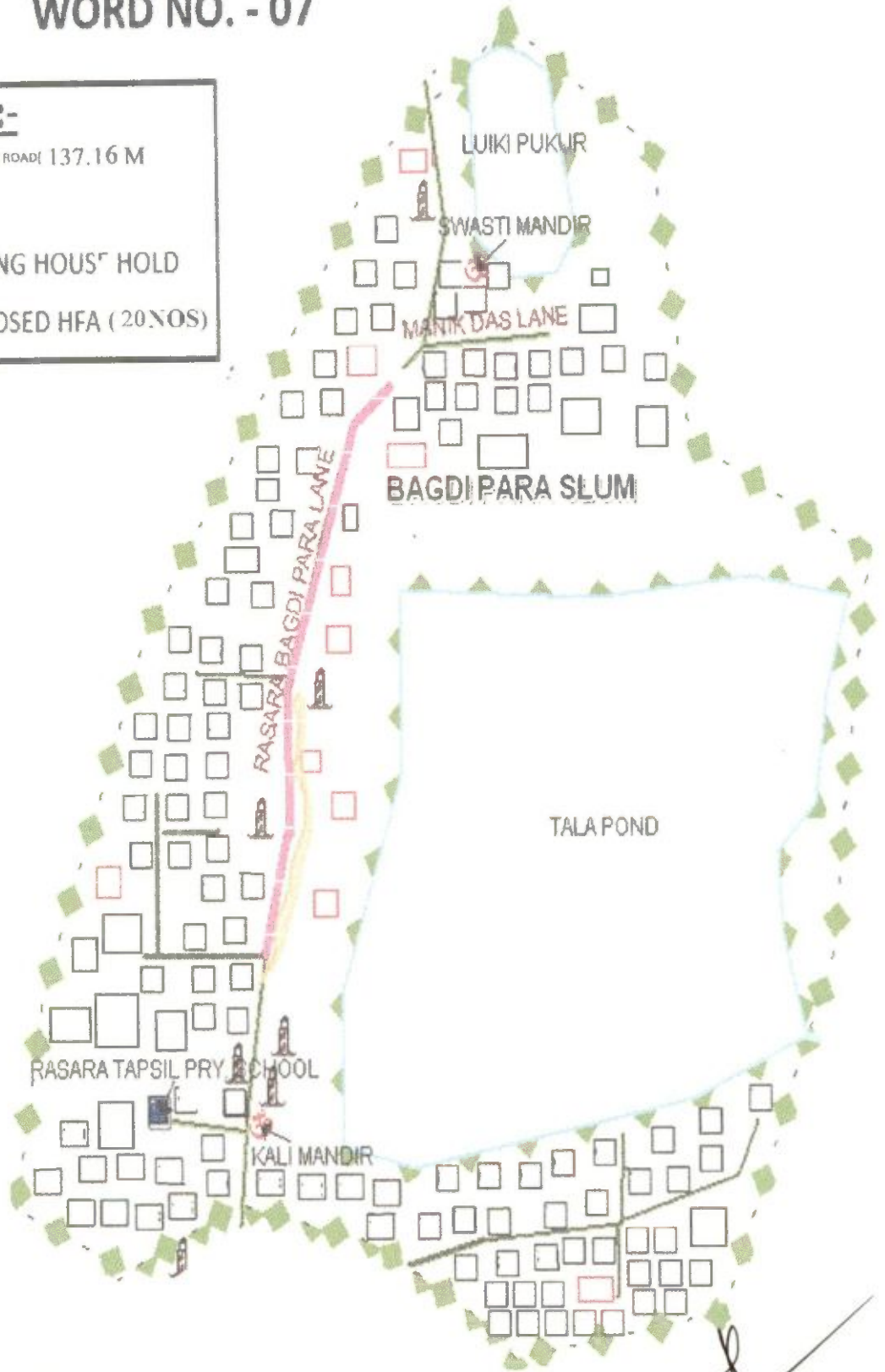
 PROPOSED HFA (20 NOS)



S. A. E.
Kandi Municipality

CHAIRMAN
KANDI MUNICIPALITY

SL. NO. 20



KANDI MUNICIPALITY

RASORAH Ghosh Para Slum (SC - 15)

Ward no- 07



LEGEND :-

-  PROPOSED CC ROAD
102.87 M
-  EXISTING HOUSE HOLD
-  PROPOSED HFA (15 NOS)



S. A. E.
Kandi Municipality

[Signature]
CHAIRMAN
KANDI MUNICIPALITY

KANDI MUNICIPLITY

Rasora paschim para slum (SC - 16)

Ward no-07



LEGEND :-

 PROPOSED CC ROAD 205.75 M

 EXISTING HOUSE HOLD

 PROPOSED HFA (30 NOS)



S. A. E.
Kandi Municipality



CHAIRMAN
KANDI MUNICIPALITY

KANDI MUNICIPLITY
Rasorah Muchipara slum (sc - 49)
Ward no - 07

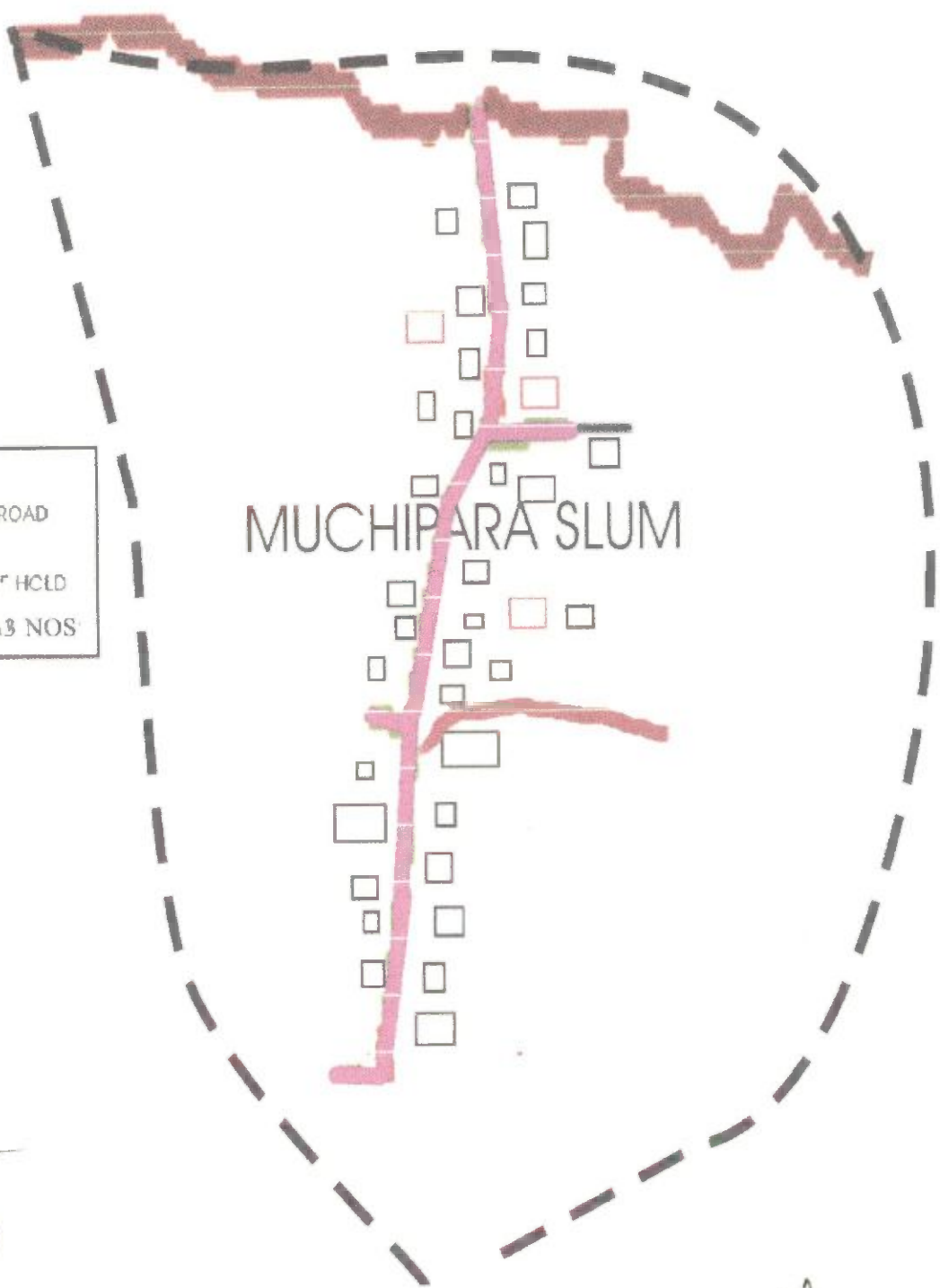

LEGEND :-

- PROPOSED CC ROAD
20.57 M
- EXISTING HOUSE HOLD
- PROPOSED HFA# NOS



S. A. E.
Kandi Municipality

CHAIRMAN
KANDI MUNICIPALITY



KALDI MUNICIPALITY
GHASI PARA SLUM (SC - 17)
WORD NO - 08

SL. NO. 23

(Signature)
 W. A. E.
 Kandi Municipality

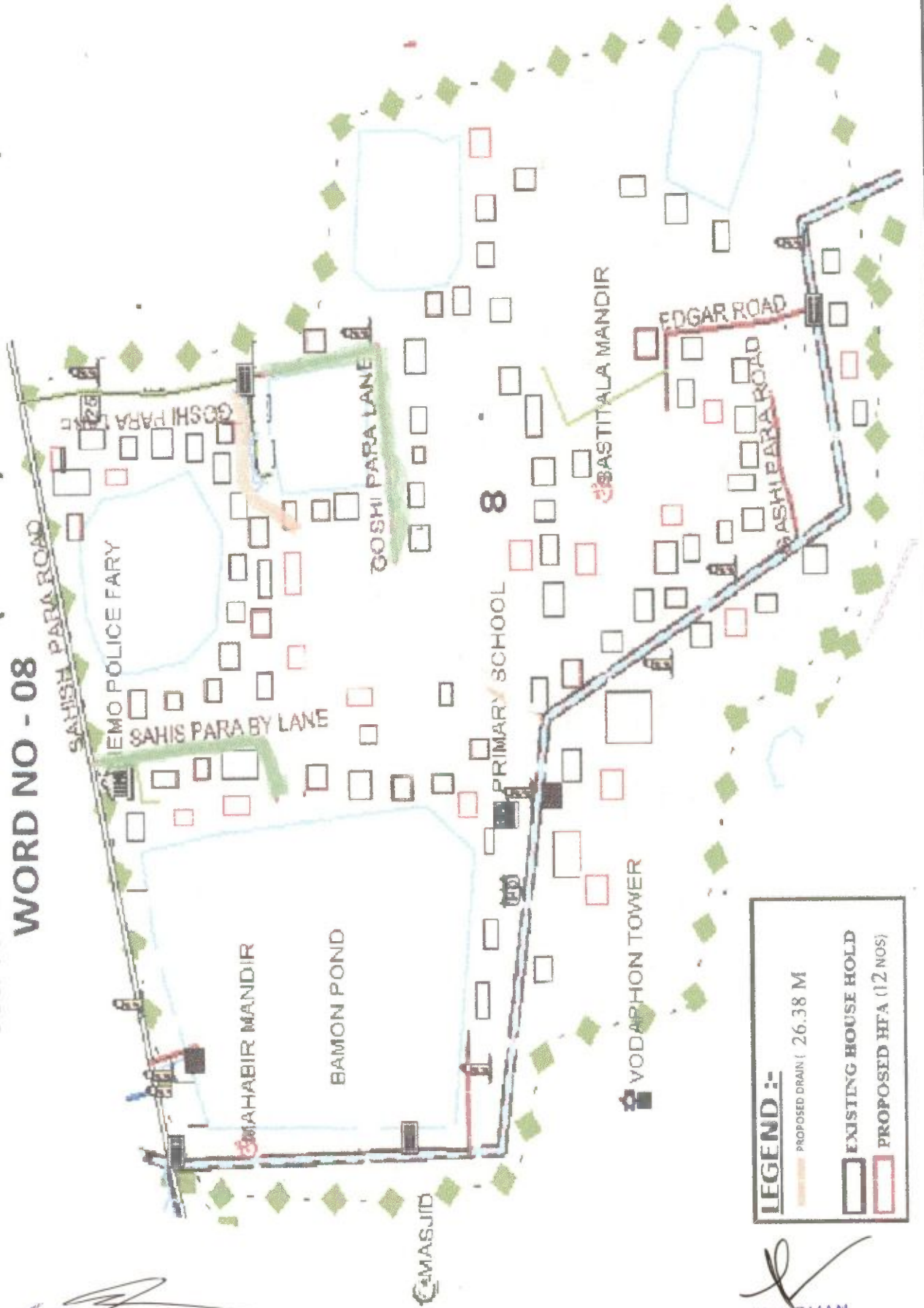

LEGEND :-

- PROPOSED DRAIN (26.38 M
- EXISTING HOUSE HOLD
- PROPOSED HFA (12 NOS)

(Signature)
 CHAIRMAN
 KANDI MUNICIPALITY

SL. NO. 24

S. A. E.
Kandi Municipality

KANDI MUNICIPALITY
Umopara Slum (SC - 018)
Ward no-08

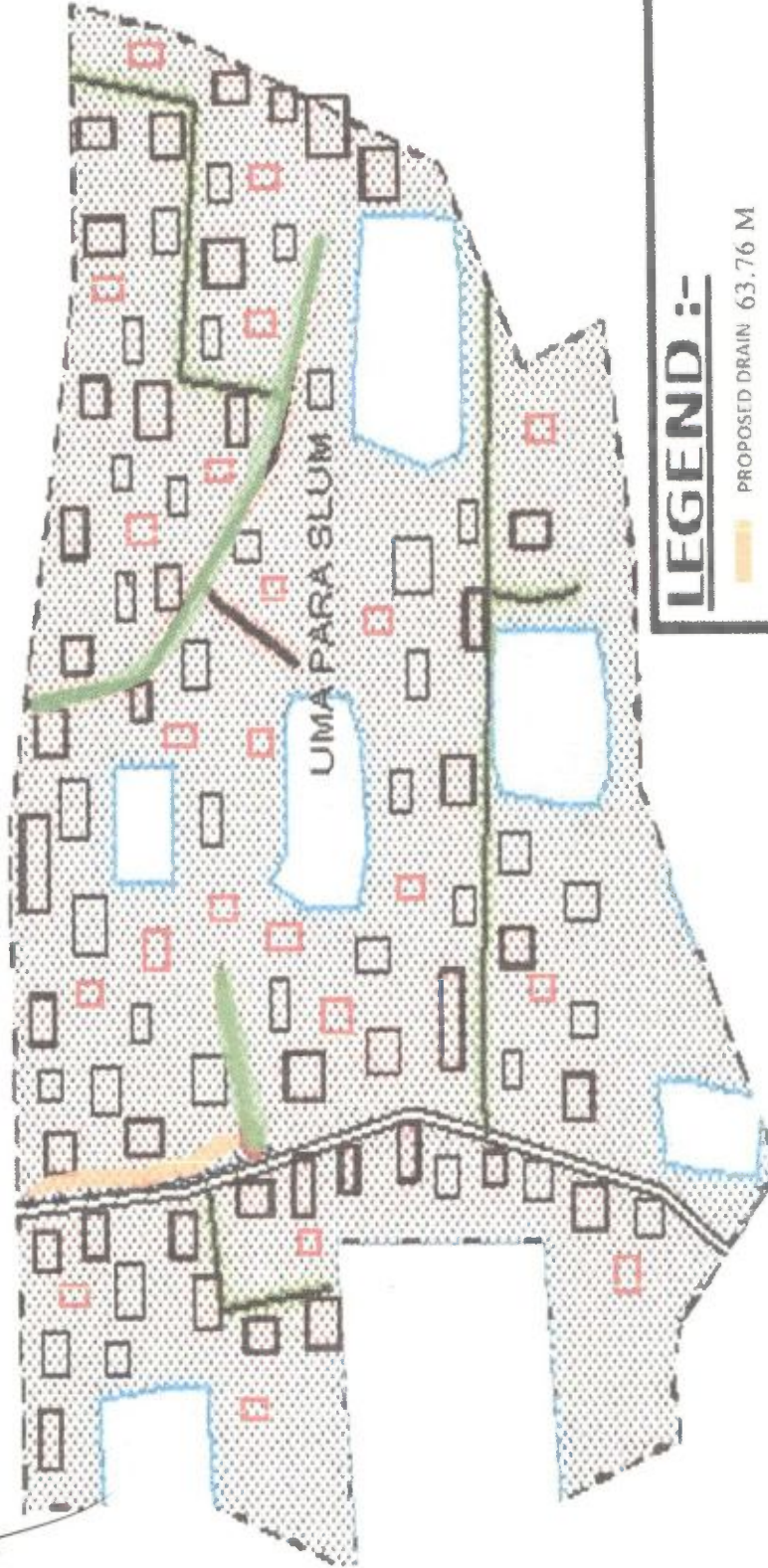

LEGEND :-

PROPOSED DRAIN 63.76 M

EXISTING HOUSE HOLD

PROPOSED HFA 29NOS)

CHAIRMAN
KANDI MUNICIPALITY



KANDI MUNICIPLITY

Muchi para slum (SC - 19)

Ward no - 08



LEGEND :-

-  PROPOSED DRAIN (8.79)
-  EXISTING HOUSE HOLD
-  PROPOSED HFA (4 NOS)

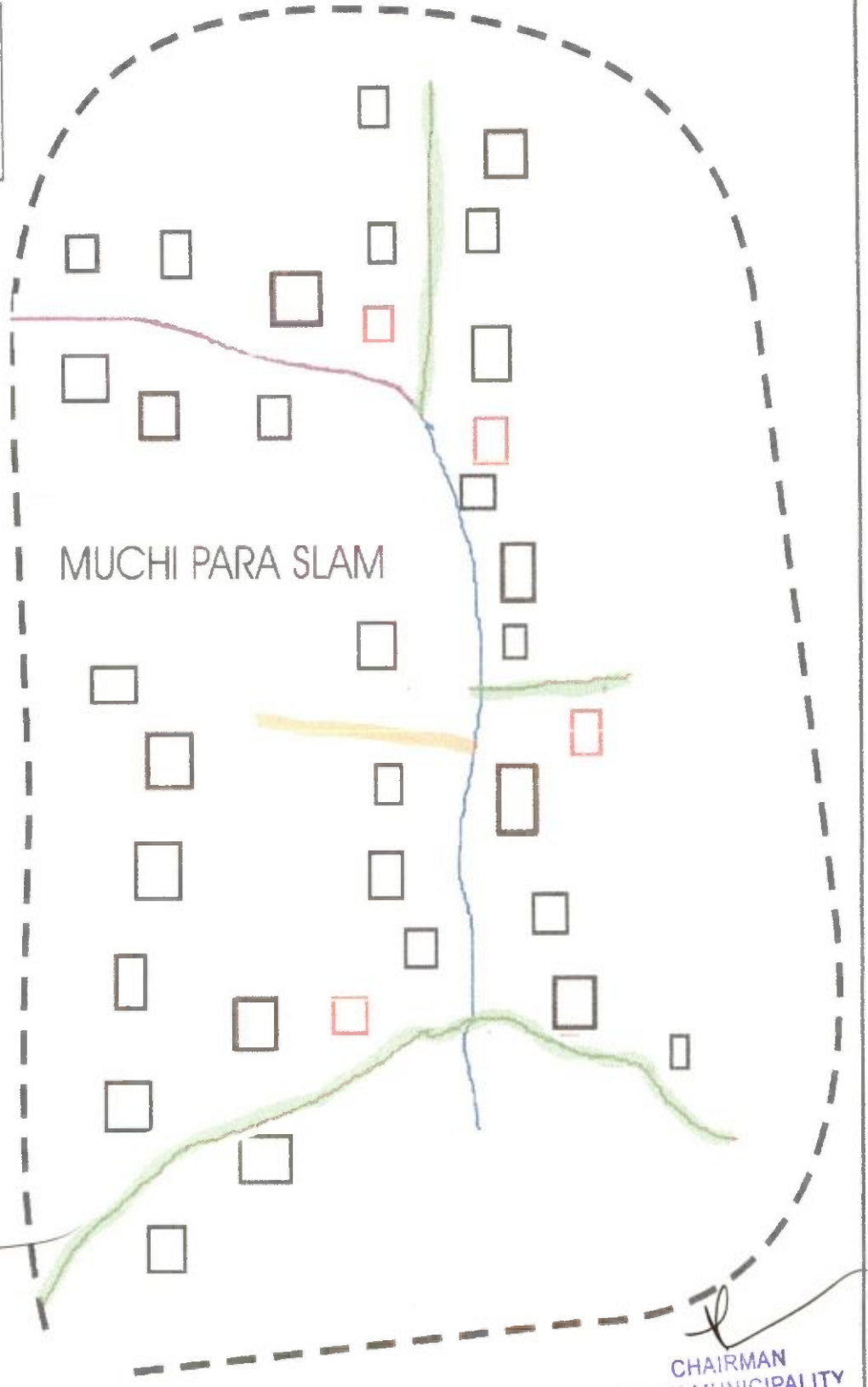

S. A. E.
Kandi Municipality

CHAIRMAN
KANDI MUNICIPALITY

KANDI MUNICIPALITY



Baganpara Slum (SC - 20)

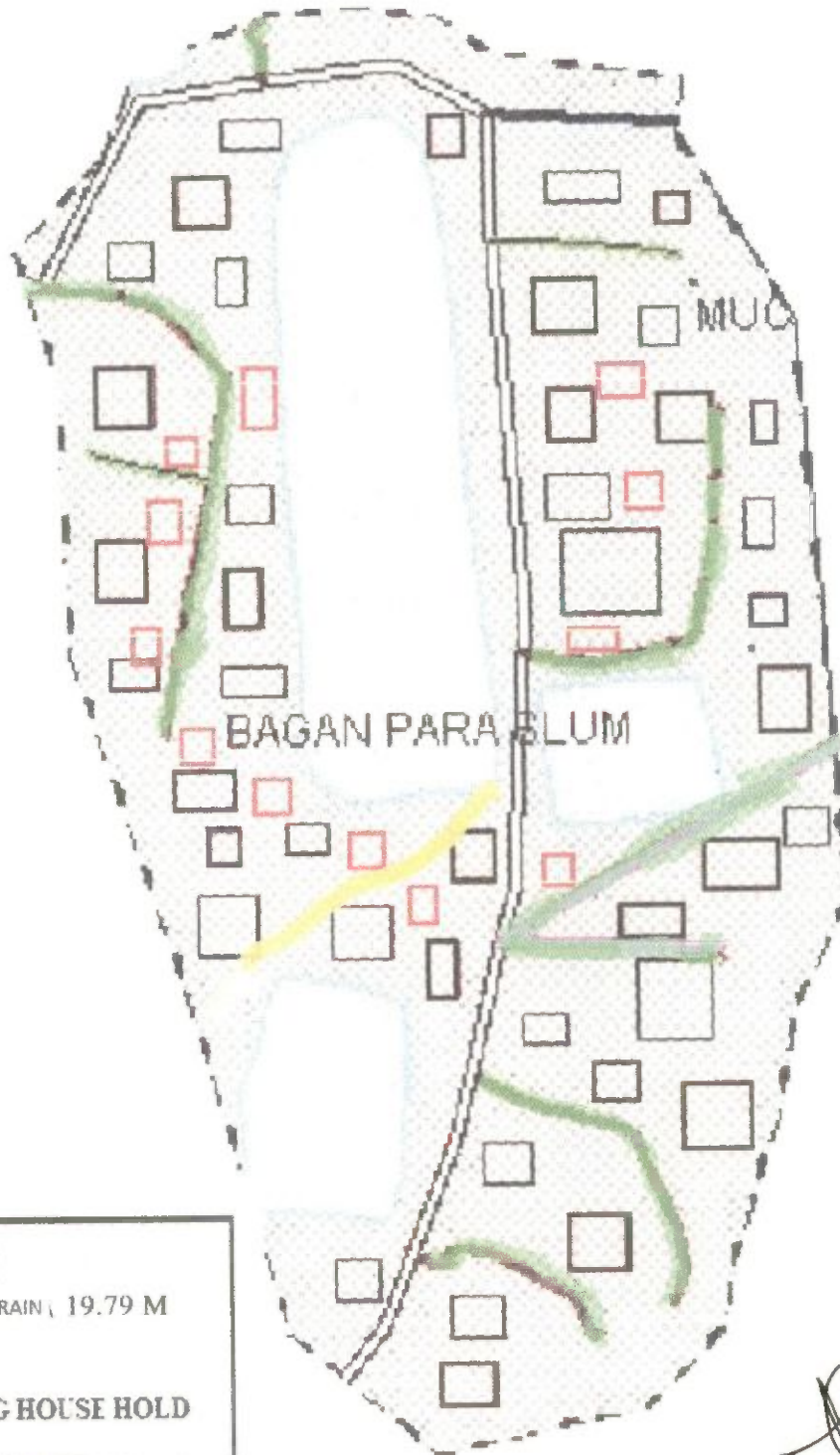

Ward no- 08



LEGEND :-

-  PROPOSED DRAIN (19.79 M
-  EXISTING HOUSE HOLD
-  PROPOSED HFA (9 NOS)

CHAIRMAN
KANDI MUNICIPALITY

S. A. E.
Kandi Municipality

KANDI MUNICIPLITY

SL. NO. 27



GHOSH PARA SLUM (SC - 021)

WARD NO - 08

LEGEND :-

- PROPOSED DRAIN
10.99 M
- EXISTING HOUSE HOLD
- PROPOSED HF. (5 NOS)

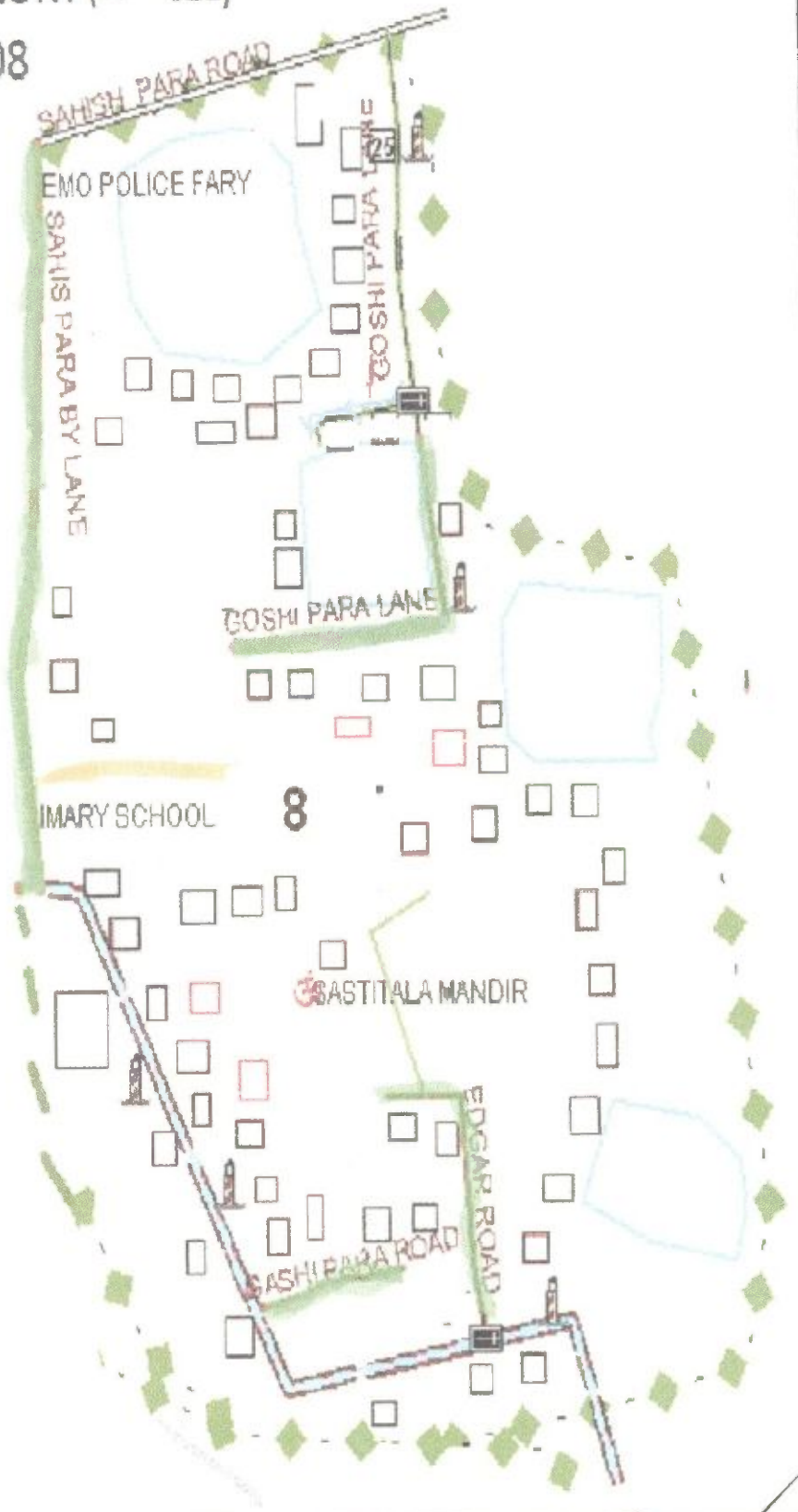

S. A. E.
Kandi Municipality

CHAIRMAN
KANDI MUNICIPALITY



KANDI MUNICIPLITY

Nilkanthapur slum SC - 050

Ward no - 08



LEGEND :-

-  PROPOSED DRAIN (32.98M)
-  EXISTING HOUSE HOLD
-  PROPOSED HFA 15 NOS



S. A. E.
Kandi Municipality

[Signature]
CHAIRMAN
KANDI MUNICIPALITY

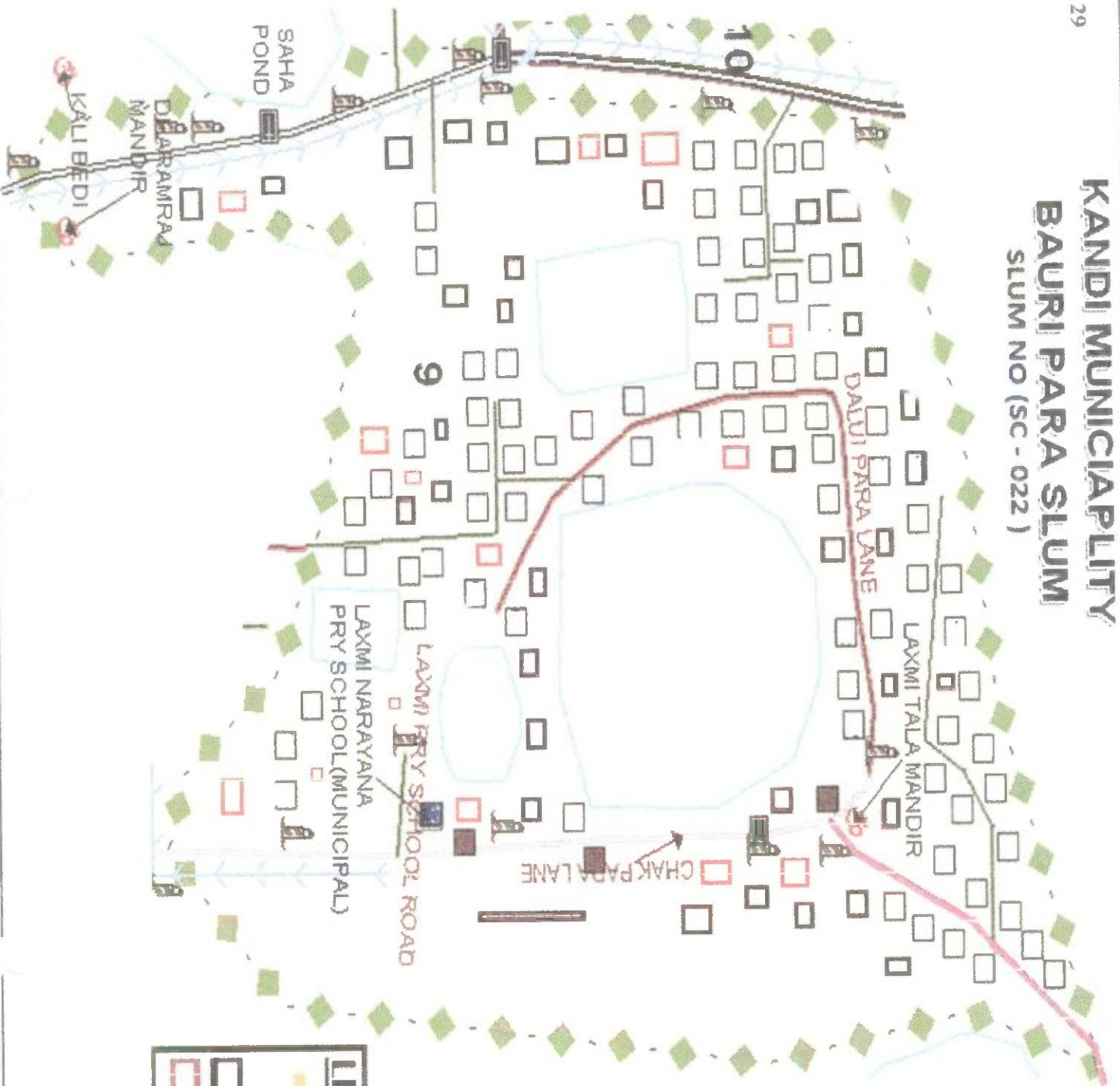

KANDI MUNICIPALITY BAURI PARA SLUM SLUM NO (SC - 022)



WARD NO - 09

[Signature]
 CHAIRMAN
 KANDI MUNICIPALITY

LEGEND :-

-  PROPOSED DRAIN 43.97 M
-  EXISTING HOUSE HOLD
-  PROPOSED HFA (20 NOS)

[Signature]
 S. A. E.
 Kandi Municipality



SL. NO. 30

KANDI MUNICIPLITY

Hazrapara Slum SLUM NO (SC - 023)

Ward no- 09

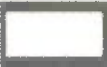
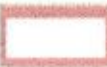

LEGEND :-

-  PROPOSED CC ROAD
54.86 M
-  EXISTING HOUSE HOLD
-  PROPOSED HFA (8 NOS)

S. A. E.
Kandi Municipality

CHAIRMAN
KANDI MUNICIPALITY



KANDI MUNICIPLITY

Raghunathpur slum SLUM NO (SC - 024)



Ward no - 09

LEGEND :-

-  PROPOSED DRAIN(43.97 M)
-  EXISTING HOUSE HOLD
-  PROPOSED HFA (20 NOS)

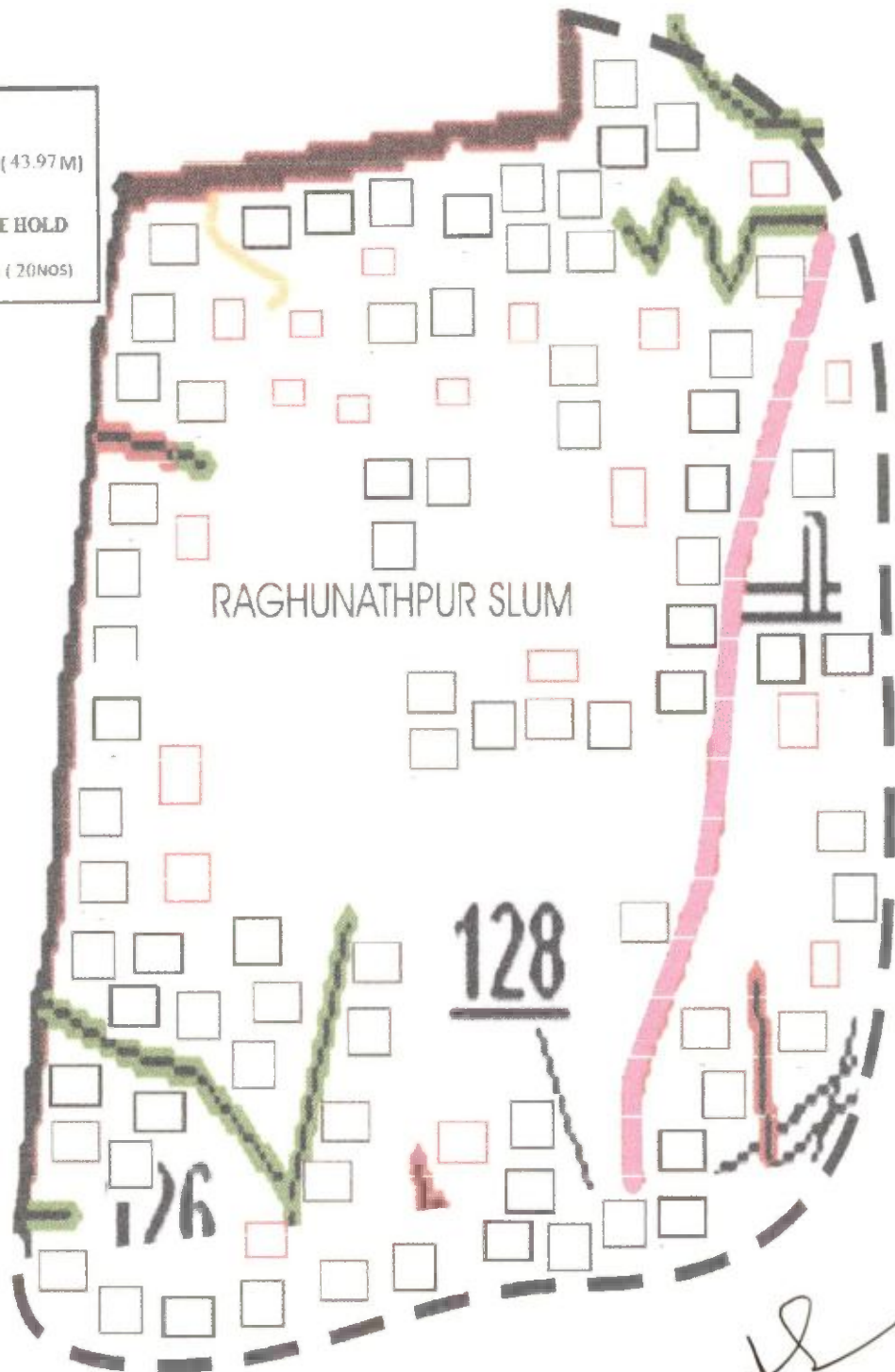

CHAIRMAN
KANDI MUNICIPALITY

S. A. E.
Kandi Municipality

SL. NO. 32

KANDI MUNICIPALITY

Tantipara Slum SIUM NO (SC - 025)

Ward no- 09



LEGEND :-

- PROPOSED DRAIN 26.38 M
- EXISTING HOUSE HOLD
- PROPOSED HFA (12NOS)

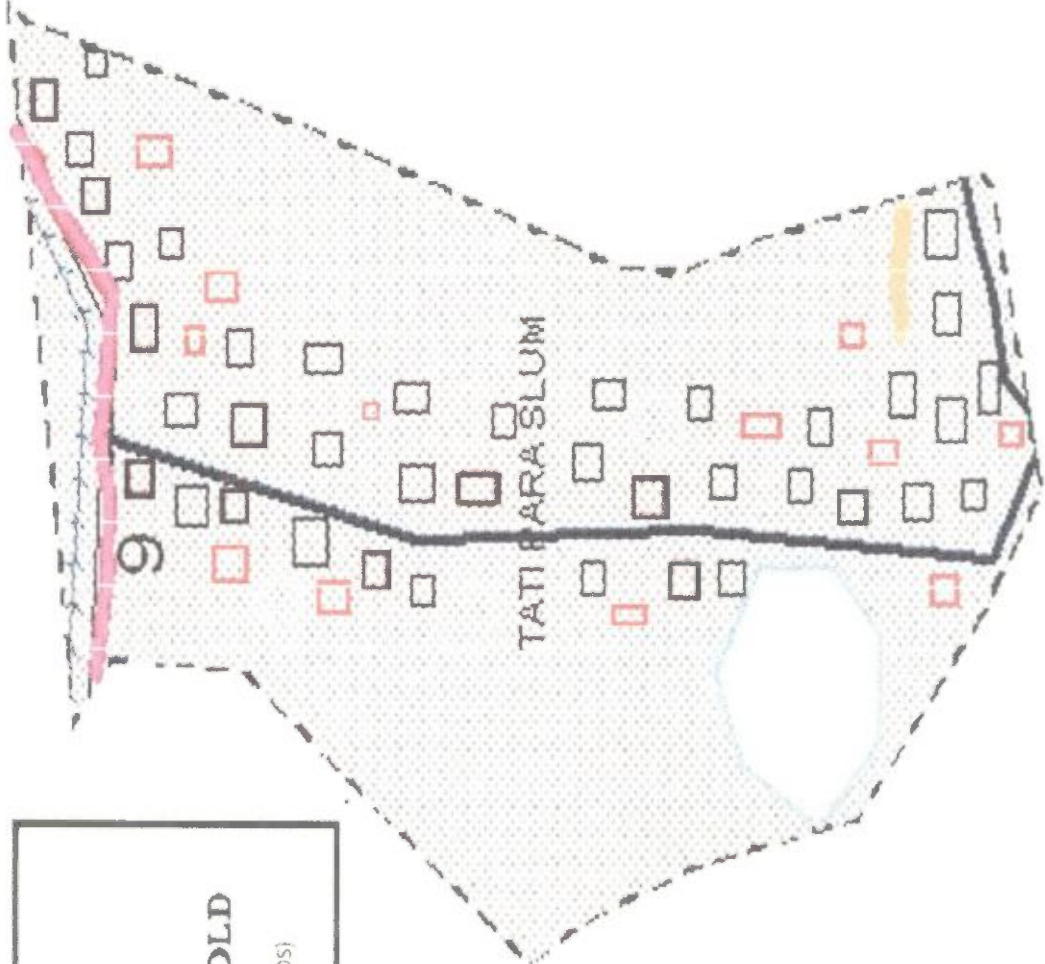



S. A. E.
Kandi Municipality

CHAIRMAN
KANDI MUNICIPALITY

KANDI MUNICIPLITY KONAIPARA GHOSH PARA SLUM (S. C. - 026) WARD NO. - 10



LEGEND :-

-  PROPOSED DRAIN 87.94 M
-  EXISTING HOUSE HOLD
-  PROPOSED HEA 40 NOS

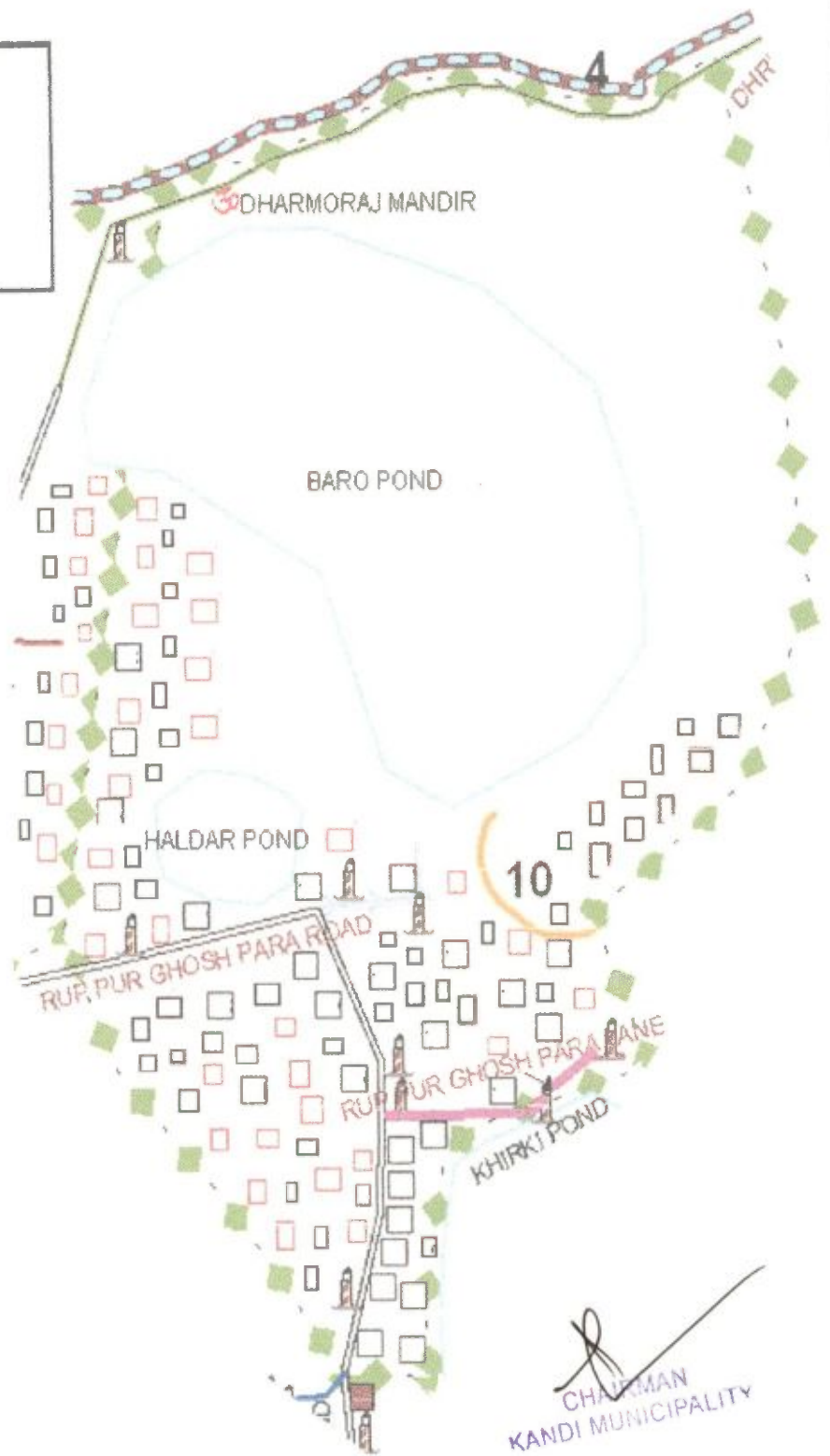



S. A. E.
Kandi Municipality

CHAIRMAN
KANDI MUNICIPALITY

SL. NO. 34

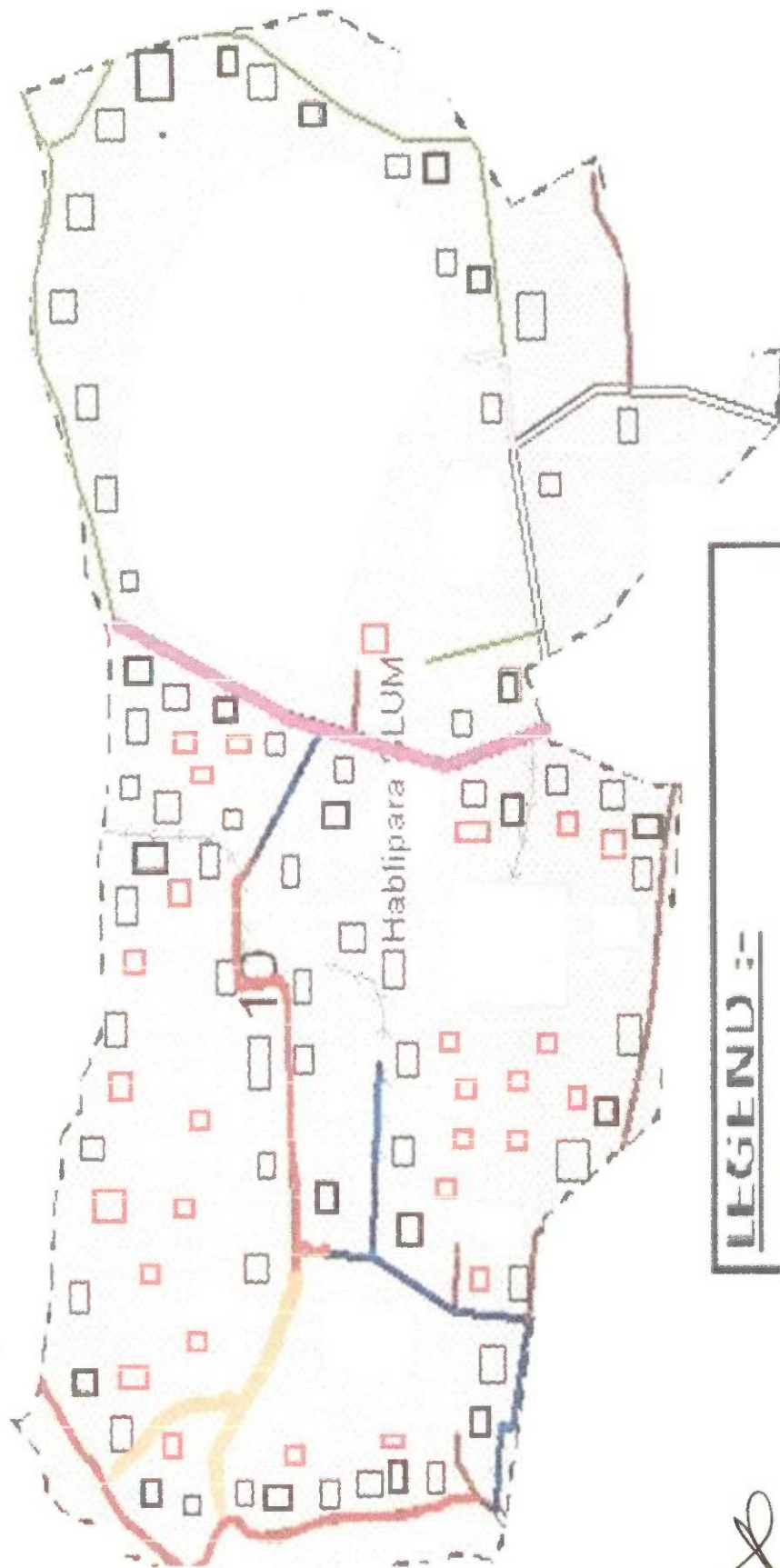
KANDI MUNICIPALITY
lablipara Slum SLUM NO. (SC. - 027)
WARD NO - 10



LEGEND :-

- PROPOSED CC ROAD
171.45 M
- EXISTING HOUSE HOLD
- PROPOSED H.F.A. 25 nos

CHAIRMAN
KANDI MUNICIPALITY

S. A. E.
Kandi Municipality



KANDI MUNICIPALITY

Harisagar par Slum

SLUM NO (SC - 028)

Ward no- 10

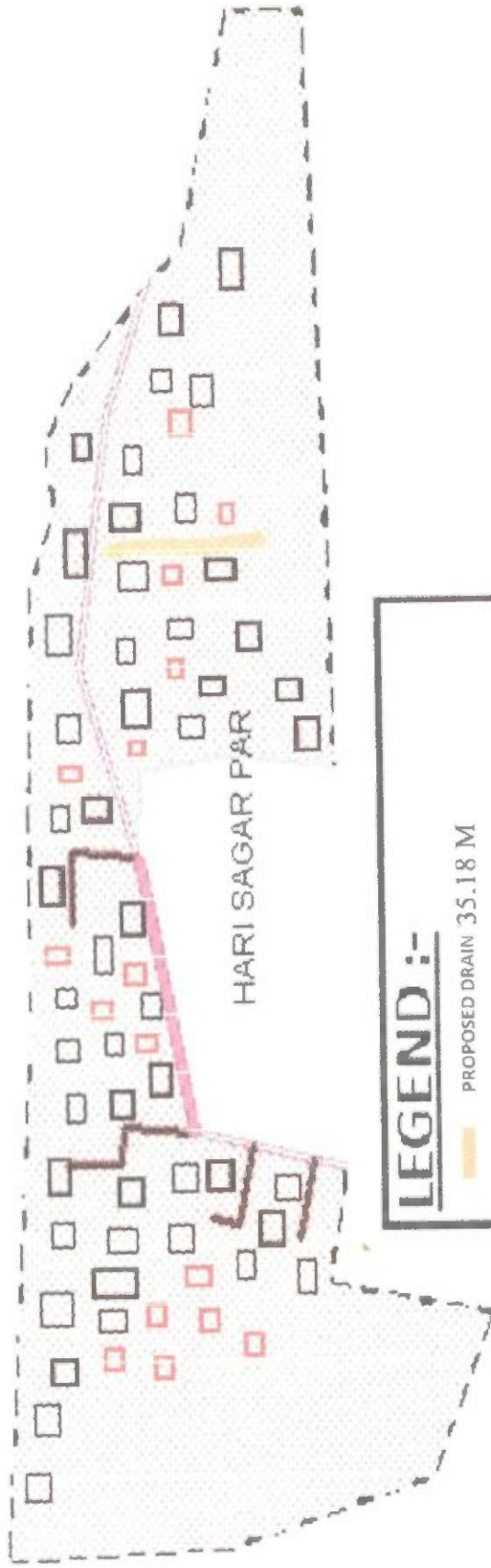

LEGEND :-

PROPOSED DRAIN 35.18 M

EXISTING HOUSE HOLD

PROPOSED H.F.A (16nos)

SL. NO. 35

S. A. E.
Kandi Municipality

CHAIRMAN
KANDI MUNICIPALITY



SL. NO. 36

KANDI MUNICIPLITY

Bagdipara jelopara slum SLUM NO-051



Ward no - 10

LEGEND :-	
	PROPOSED DRAIN (8.79 M)
	EXISTING HOUSE HOLD
	PROPOSED HFA (4 NOS)

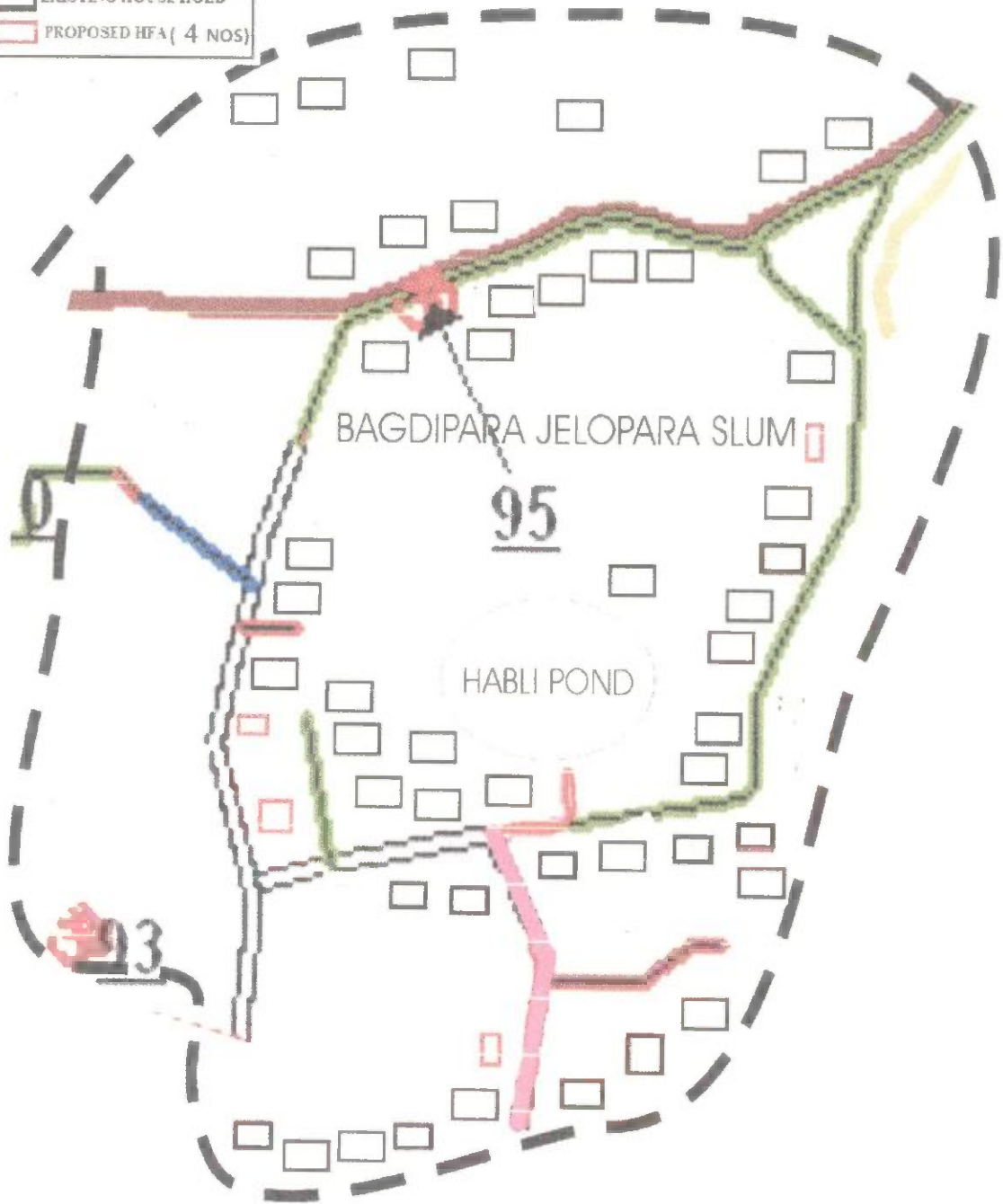

S. A. E.
Kandi Municipality

CHAIRMAN
KANDI MUNICIPALITY



KANDI MUNICIPLITY

GOURTALA BANI SANGHA GROUND SLUM NO. - 052

Ward no - 10



LEGEND :-

-  PROPOSED CC ROAD
102.87 M
-  EXISTING HOUSE HOLD
-  PROPOSED HFA (15 NOS)

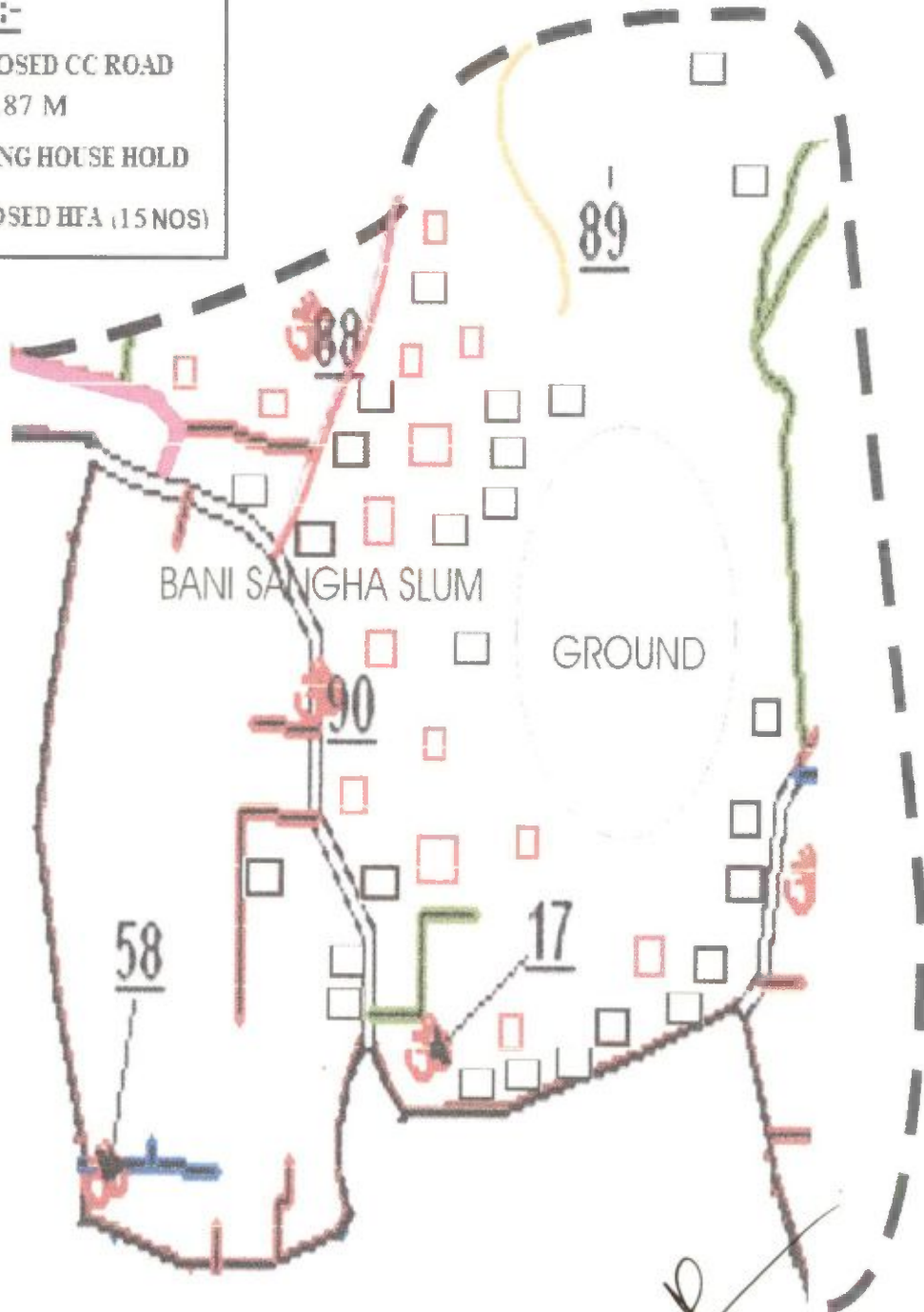

BANI SANGHA SLUM

GROUND

88

89

90

58

17

S. A. E.
Kandi Municipality

CHAIRMAN
KANDI MUNICIPALITY

KANDI MUNICIPLITY



Sibrambati baropara SLUM NO-(SC.-029)

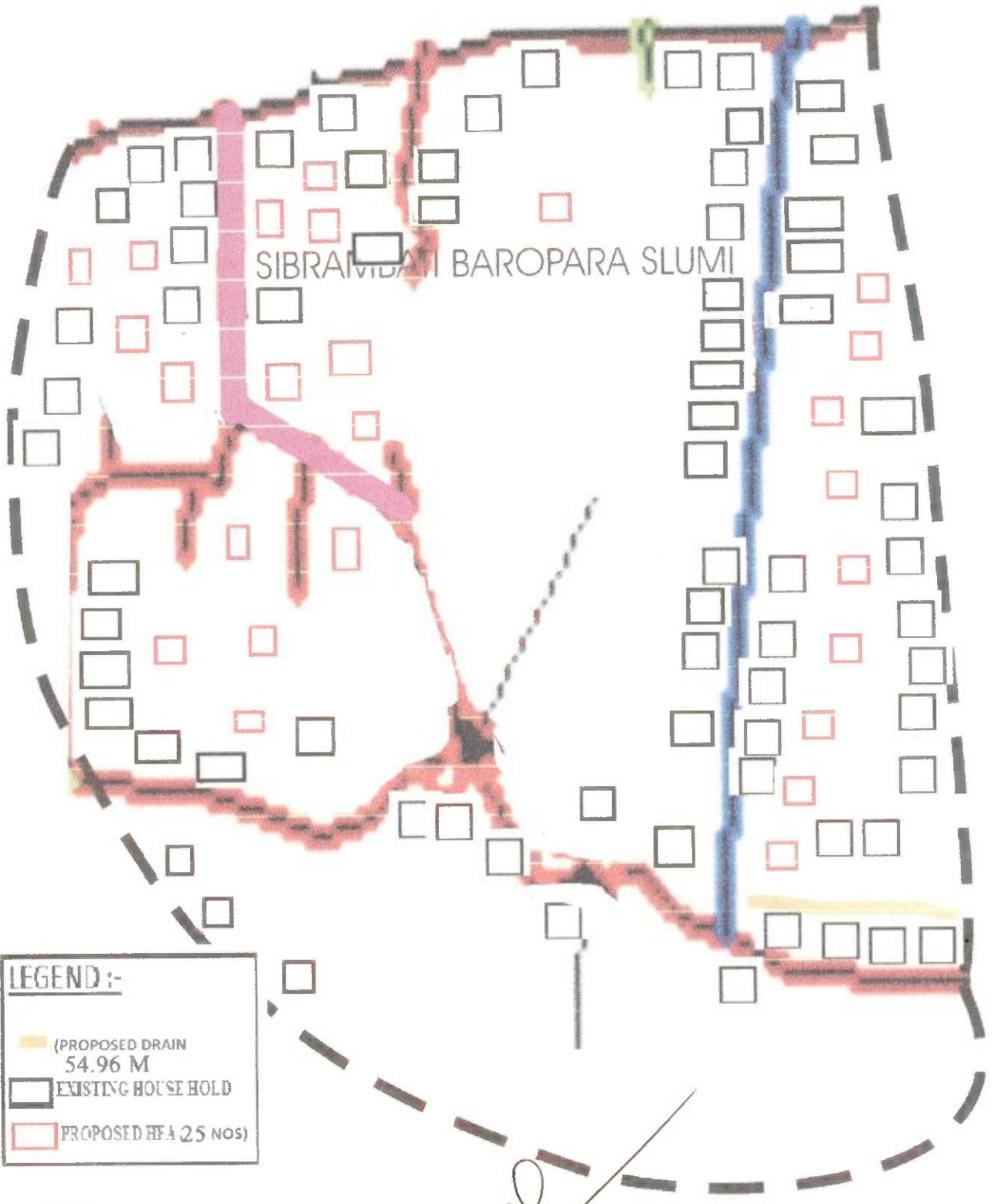

Ward no - 11



LEGEND :-

-  (PROPOSED DRAIN 54.96 M)
-  EXISTING HOUSE HOLD
-  PROPOSED HEA (25 NOS)

S. A. E.
Kandi Municipality

[Signature]
CHAIRMAN
KANDI MUNICIPALITY

KANDI MUNICIPLITY



Bijoy Nagar Talarpar



SLUM NO (SC - 030)

Ward no-11

LEGEND :-

-  PROPOSED CC ROAD
164.59 M
-  EXISTING HOUSE HOLD
-  PROPOSED HFA (24NOS)

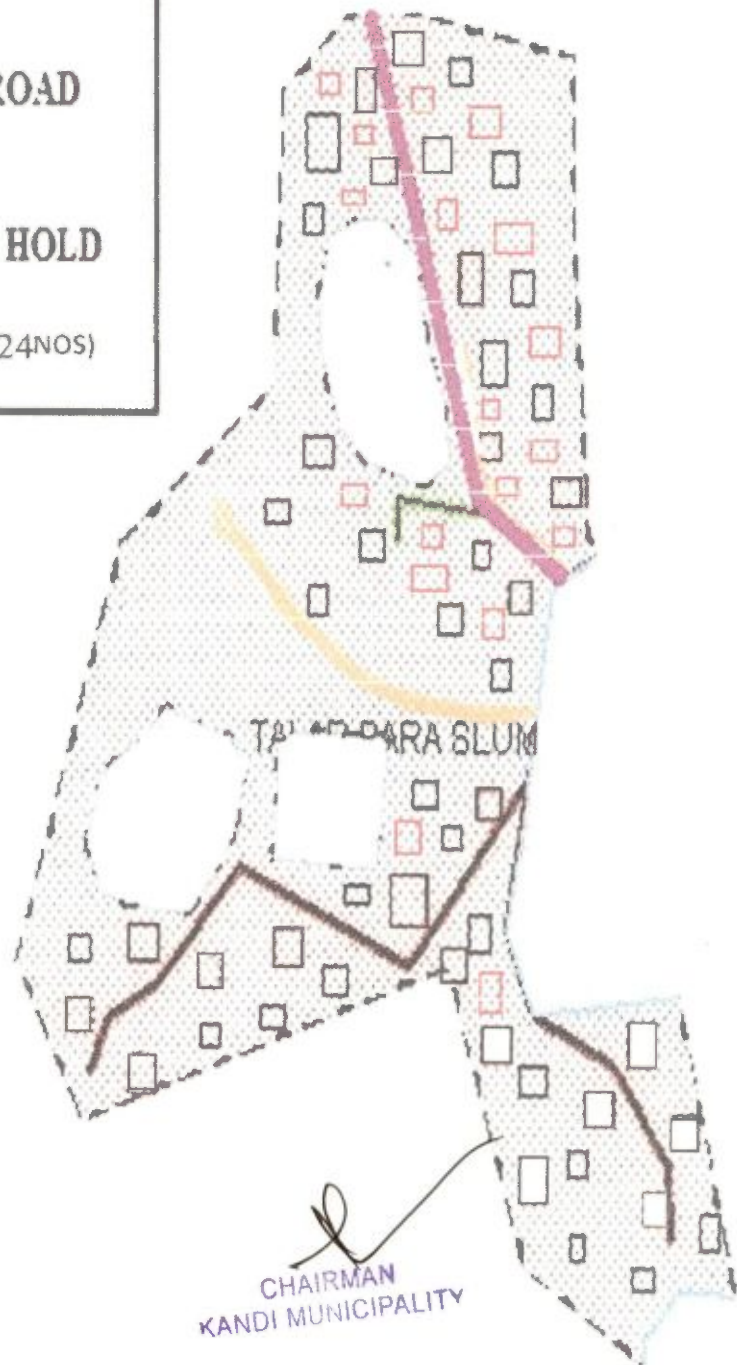

CHAIRMAN
KANDI MUNICIPALITY

S. A. E.
Municipality



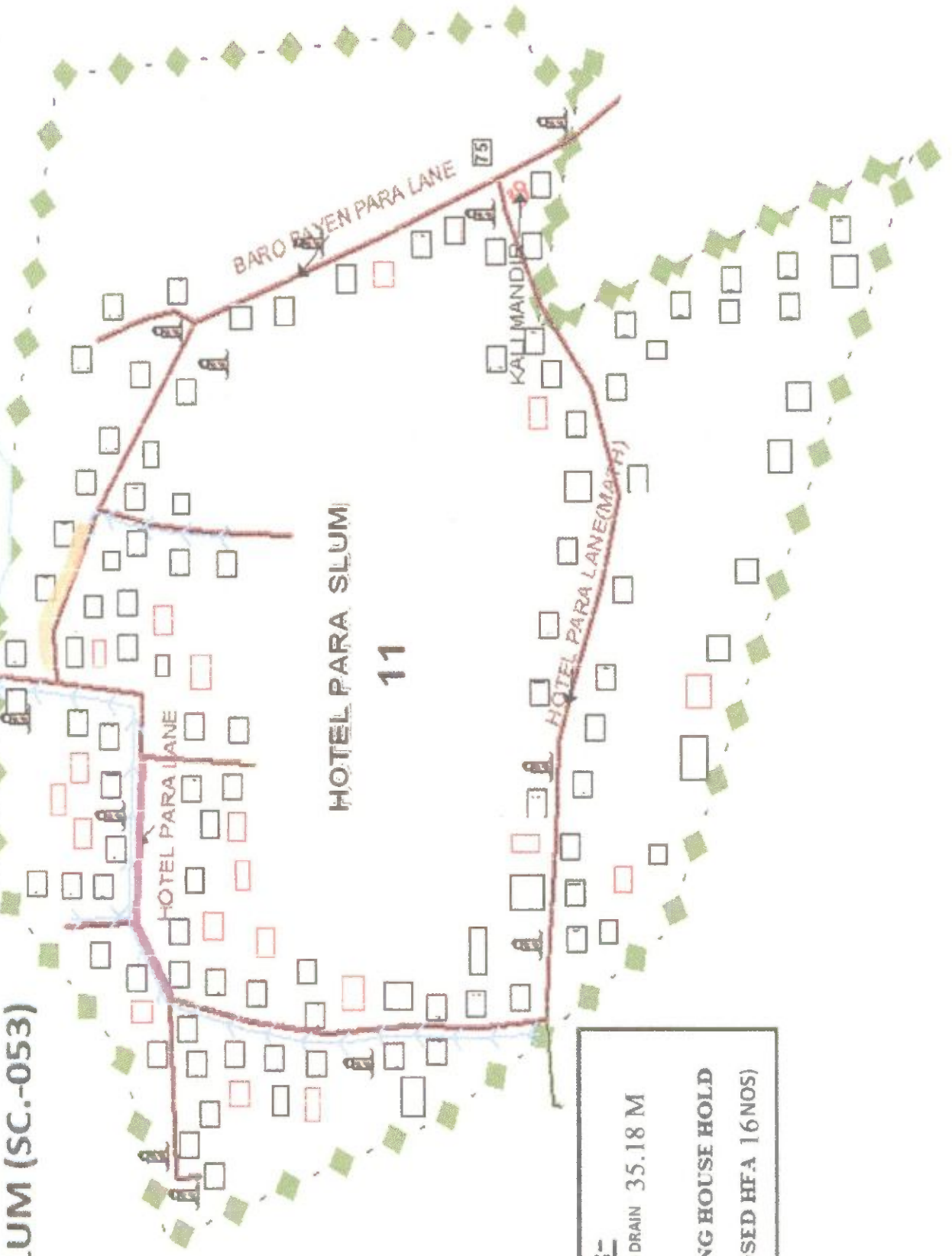

WARD NO - 11

**KANDI MUNICIPALITY
HOTEL PARA SLUM
SLUM (SC.-053)**



**HOTEL PARA SLUM
11**

LEGEND :-

-  PROPOSED DRAIN 35.18 M
-  EXISTING HOUSE HOLD
-  PROPOSED HFA (6 NOS)

SL. NO. 40

S. A. E.
Kandi Municipality

[Signature]
CHAIRMAN
KANDI MUNICIPALITY

SL. NO. 41



KANDI MUNICIPLITY

Chandalpara SLUM NO (SC - 054)

Ward no - 11



LEGEND :-

-  PROPOSED CC ROAD
41.15 M
-  EXISTING HOUSE HOLD
-  PROPOSED HFA (6 NOS)

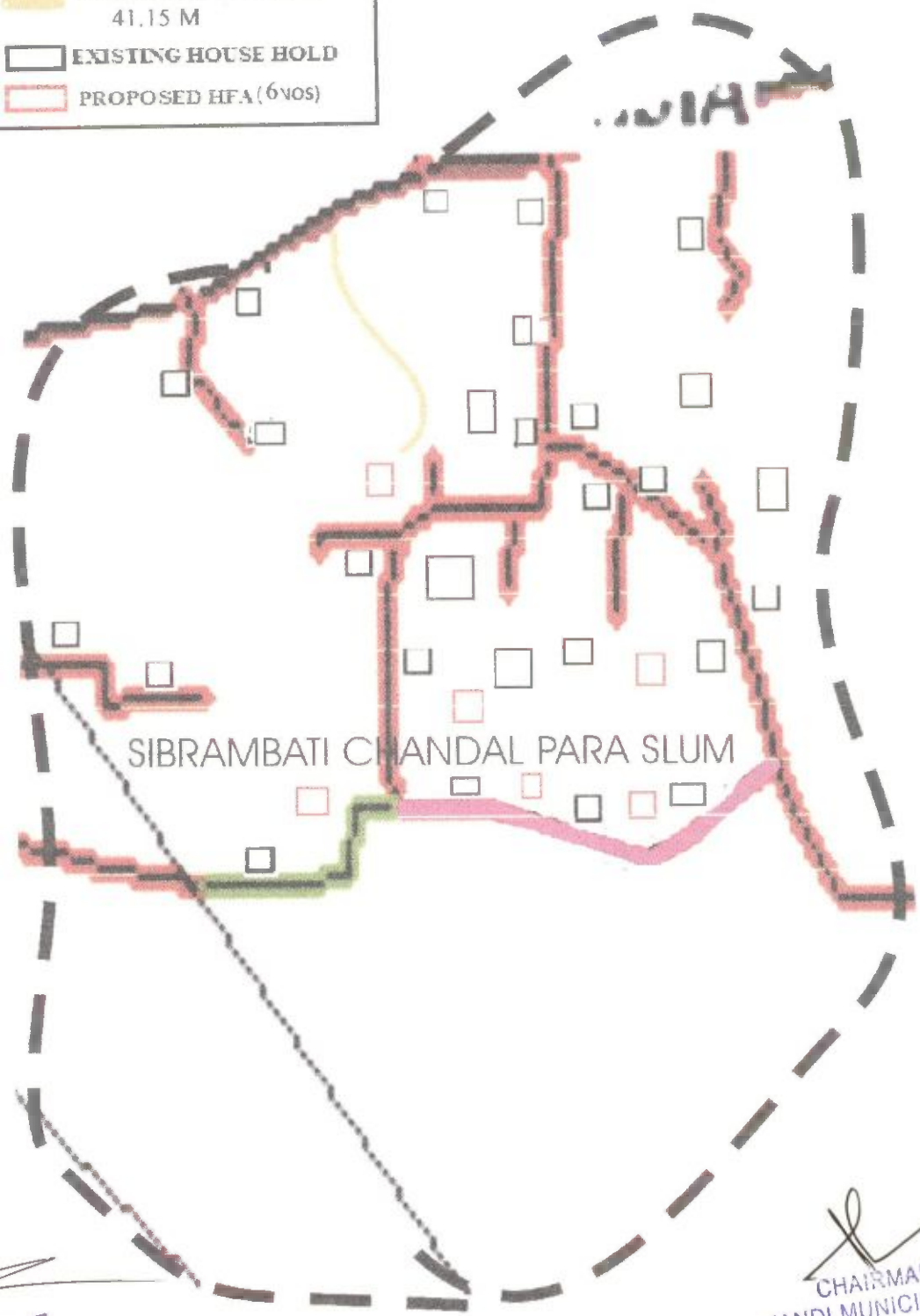

SIBRAMBATI CHANDAL PARA SLUM

S. A. E.
Kandi Municipality

CHAIRMAN
KANDI MUNICIPALITY



KANDI MUNICIPLITY

Sibrambati baropara SLUM NO-(SC.-029)

Ward no - 11

- LEGEND :-**
- PROPOSED CC ROAD
75.44 M
 - EXISTING HOUSE HOLD
 - PROPOSED HEADINGS

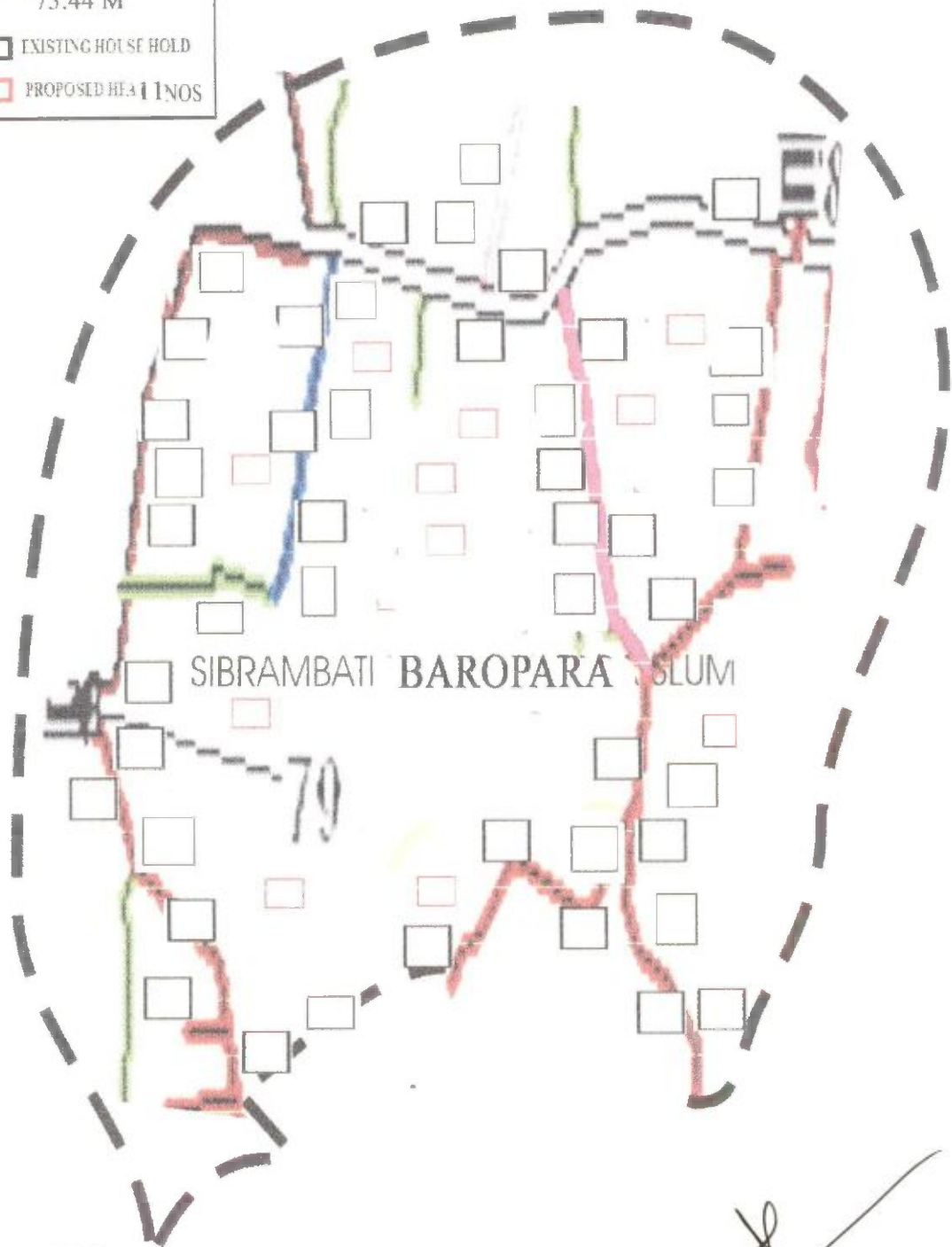



S. A. E.
Kandi Municipality

CHAIRMAN
KANDI MUNICIPALITY



KANDI MUNICIPALITY
NAMUBAGDANGA(EAST) S.C-031
WARDNO.12

LEGEND :-

-  PROPOSED DRAIN 15.39 M
-  EXISTING HOUSE HOLD
-  PROPOSED H.F.A 7 NOS



SL. NO. 43

S. A. E.
 Kandi Municipality

[Signature]
 CHAIRMAN
 KANDI MUNICIPALITY

KANDI MUNICIPALITY

JakhaDanga nort slum S.C. - 032



Ward no - 12

LEGEND :-

- PROPOSED DRAIN
15.39 M
- EXISTING HOUSE HOLD
- PROPOSED HFA 7 nos

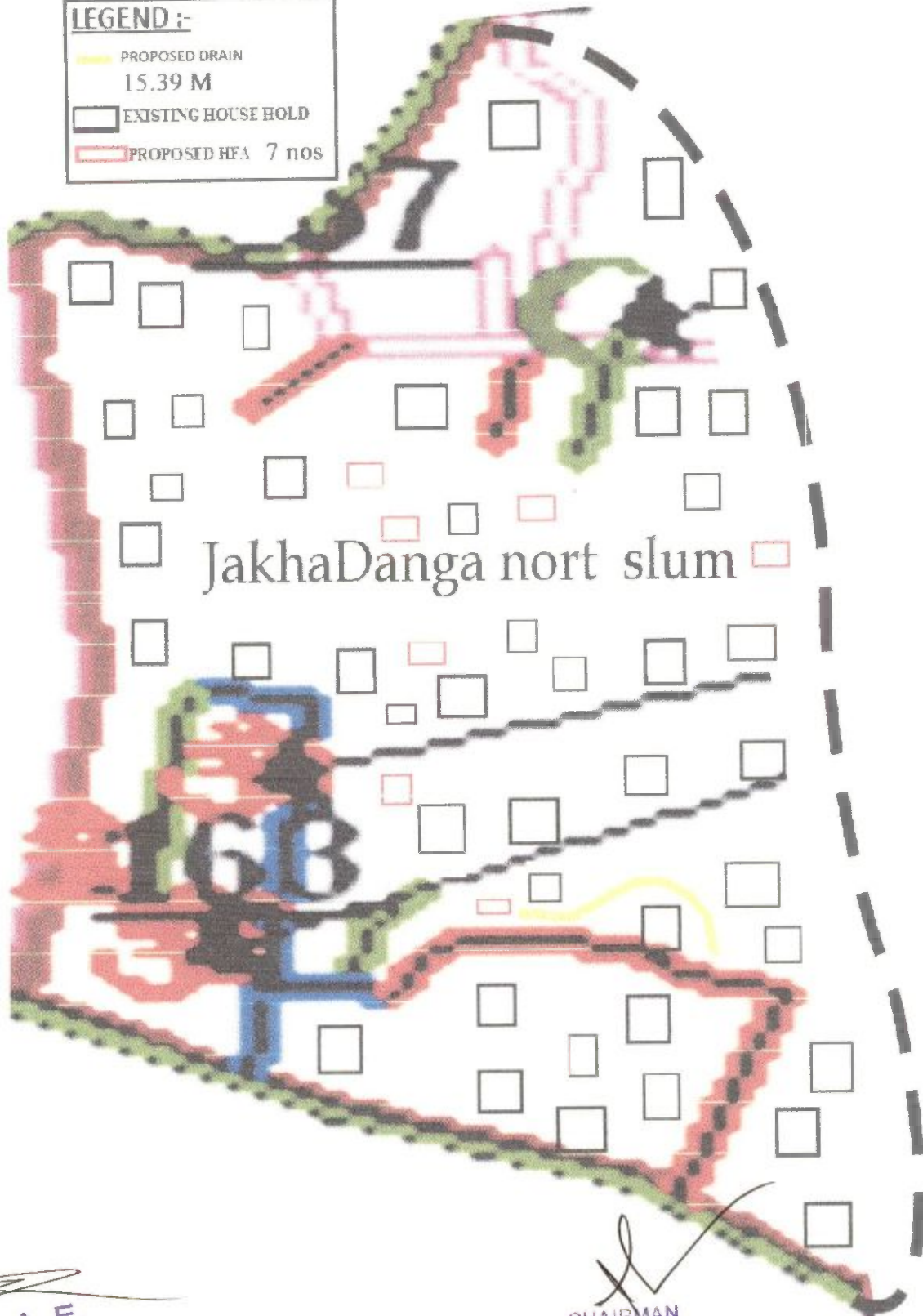

S. A. E.
Kandi Municipality

CHAIRMAN
KANDI MUNICIPALITY

KANDI MUNICIPLITY

Ghurupara slum (S.C.-033)

Ward no - 12



LEGEND :-

- PROPOSED DRAIN
15.39 M
- EXISTING HOUSE HOLD
- PROPOSED HFA 7 NOS

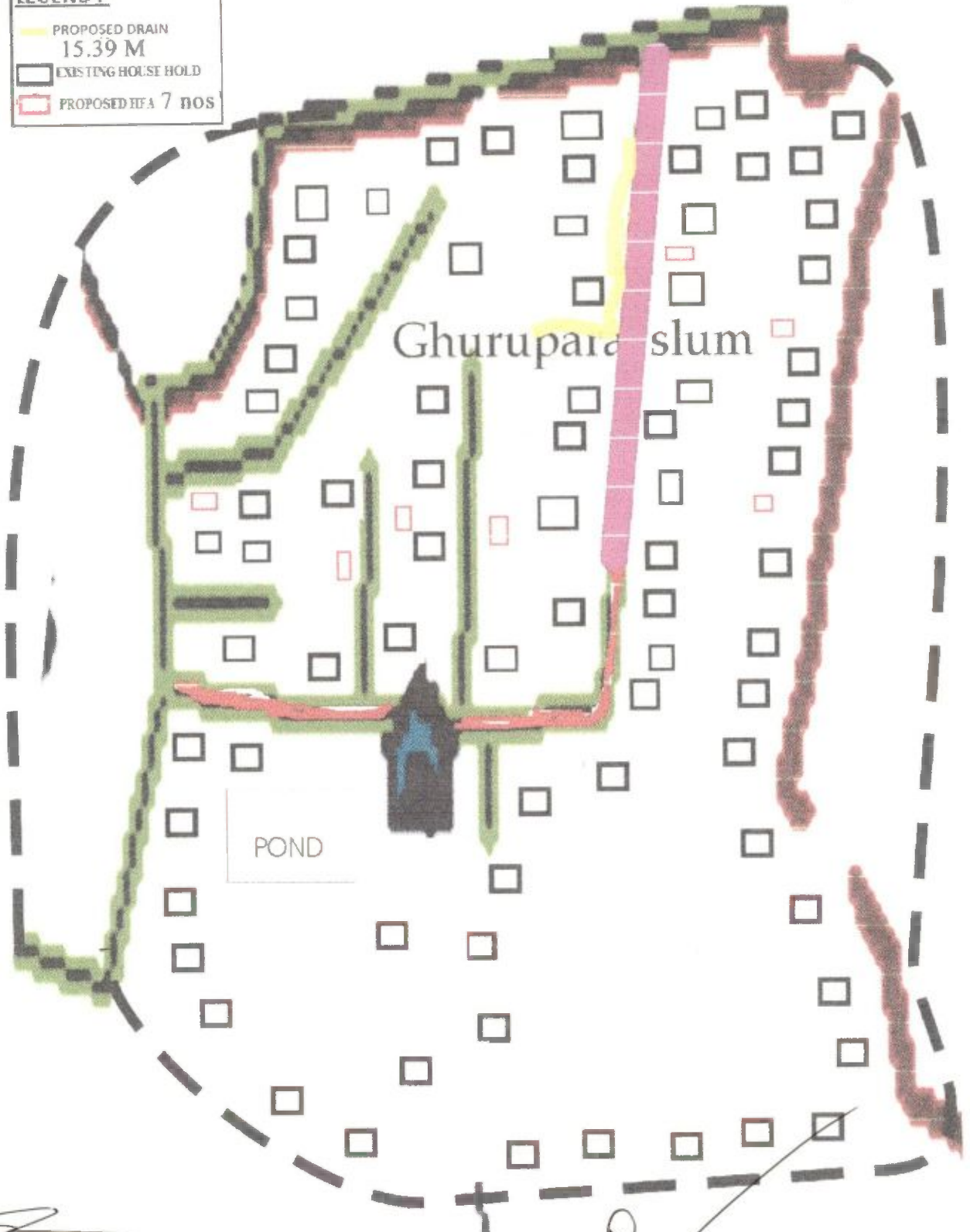

S. A. E.
Kandi Municipality

CHAIRMAN
KANDI MUNICIPALITY

KANDI MUNICIPALITY
Jhakhadanga Slum SC - 056
Ward no-12

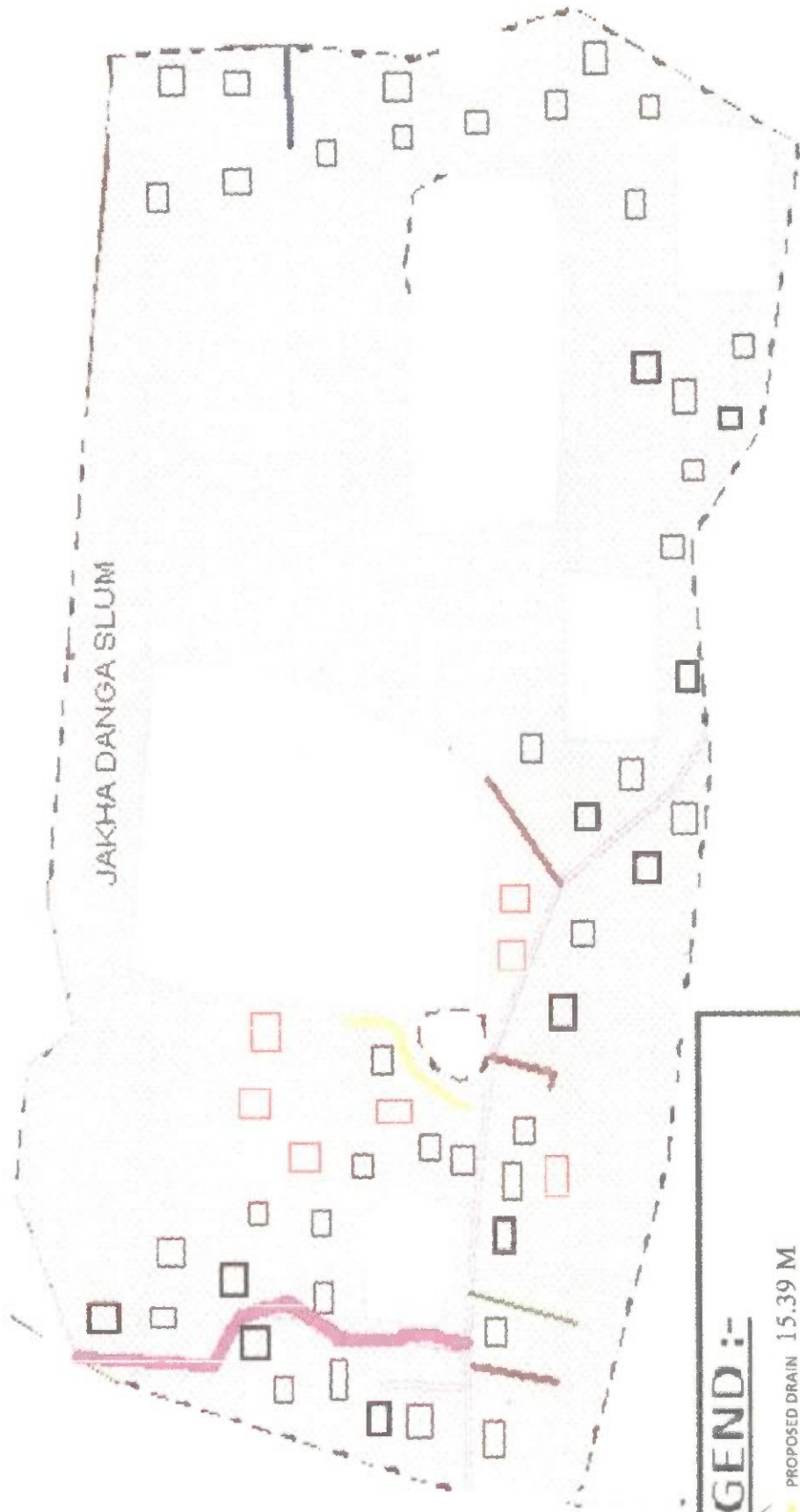

LEGEND :-

PROPOSED DRAIN 15.39 M

EXISTING HOUSE HOLD

PROPOSED HFA 7 NOS)

S. A. E.
Kandi Municipality

CHAIRMAN
KANDI MUNICIPALITY

KANDI MUNICIPLITY NAMO BAGDANGA SLUM (WEST) S.C.-057, WARD NO.12

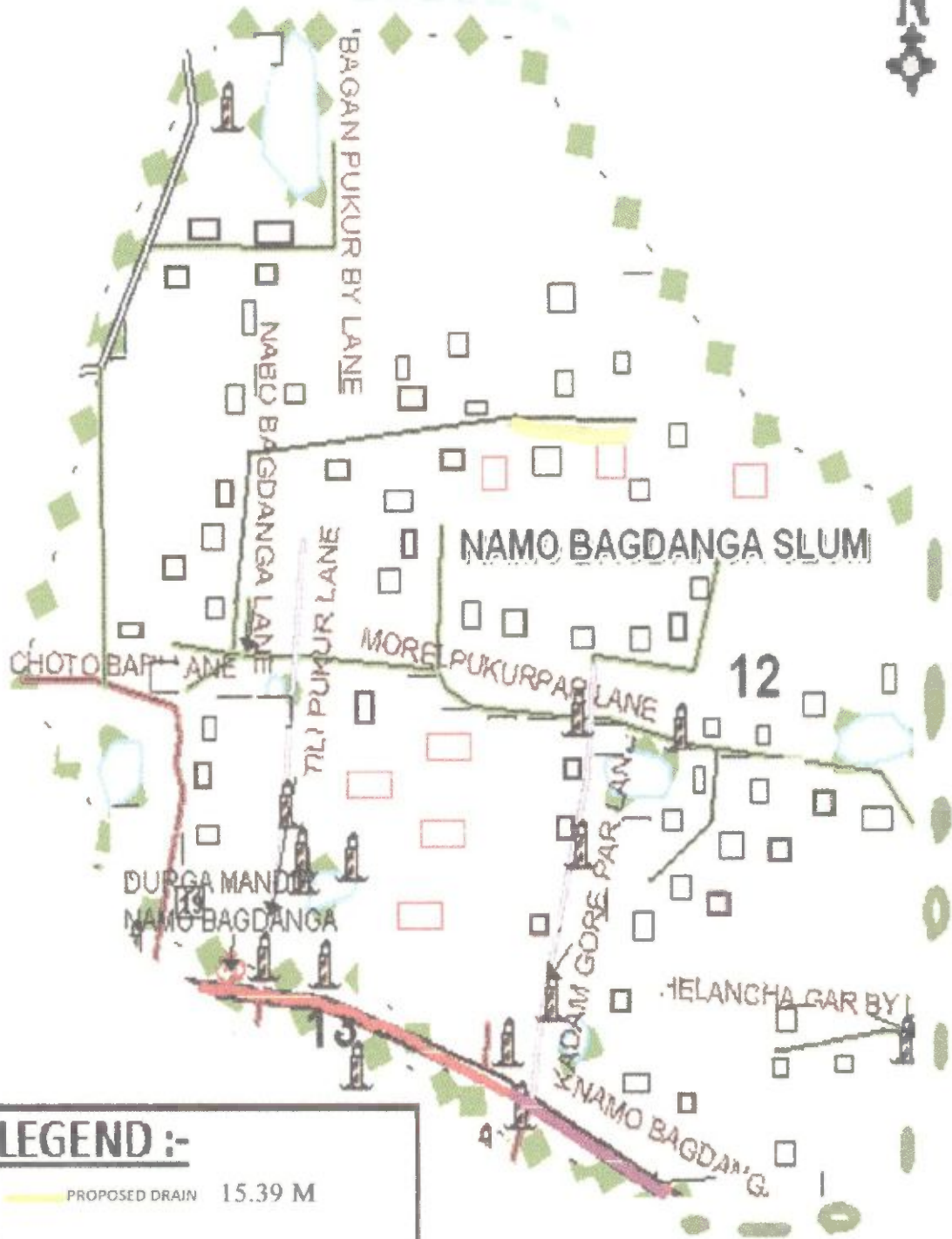

LEGEND :-

- PROPOSED DRAIN 15.39 M
- EXISTING HOUSE HOLD
- PROPOSED HFA (7 NOS)

CHAIRMAN
KANDI MUNICIPALITY



S. A. E.
Kandi Municipality



KANDI MUNICIPLITY
NAMUBAGDANGA(WEST) S.C.-034
WARD NO.-13



LEGEND :-

-  PROPOSED CC ROAD (102.87 M)
-  EXISTING HOUSE HOLD
-  PROPOSED H.F.A (15 NOS)

SL. NO. 48

S. A. E.
 Kandi Municipality

 CHAIRMAN
 KANDI MUNICIPALITY



KANDI MUNICIPALITY
NOAPARA SLUM (S.C.-035)
WARD NO.13

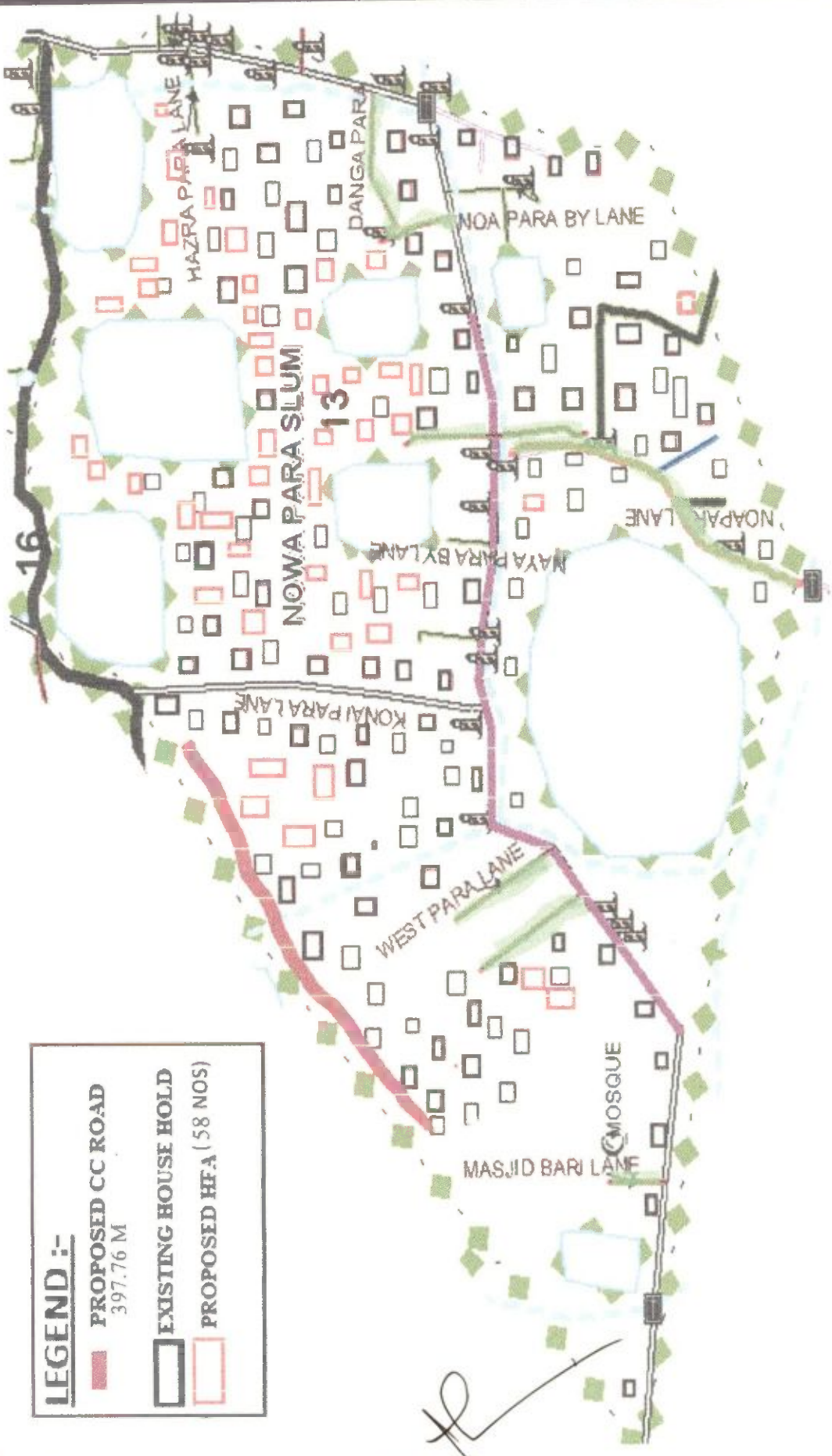

LEGEND :-

	PROPOSED CC ROAD 397.76 M
	EXISTING HOUSE HOLD
	PROPOSED HEA (58 NOS)

SL. NO. 49

S. A. E.
 Kandi Municipality

[Signature]
 CHAIRMAN
 KANDI MUNICIPALITY



KANDI MUNICIPALITY Boalia Slum (S.C.-036)

Ward no-13

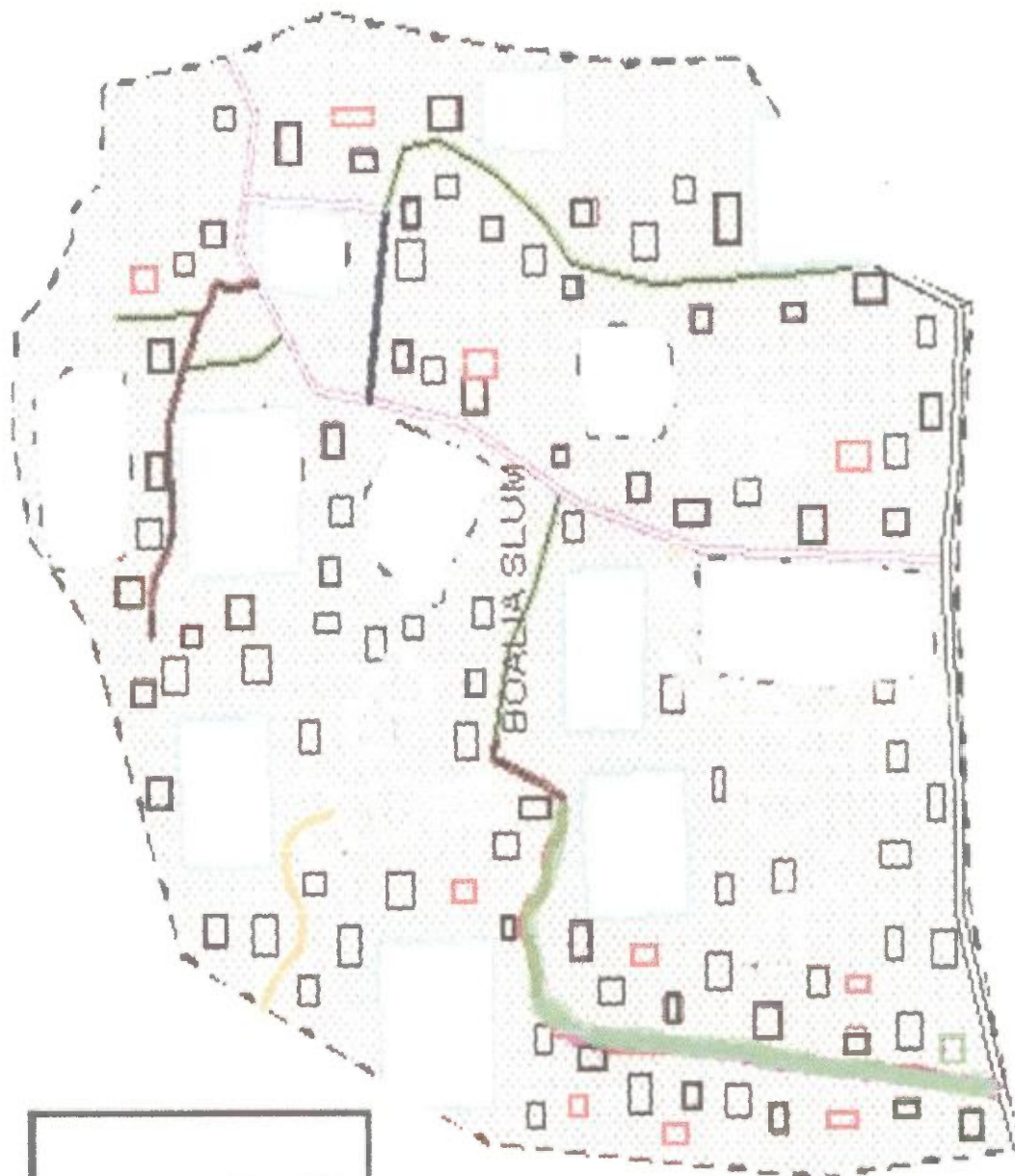

LEGEND :-

 PROPOSED CC ROAD
137.16 M

 EXISTING HOUSE HOLD

 PROPOSED HFA (20 NOS)

SL. NO. 50

S. A. E.
Kandi Municipality



CHAIRMAN
KANDI MUNICIPALITY

KANDI MUNICIPALITY

PIRTOLA CHASAPARA(S.C.-037)

WARD NO-14

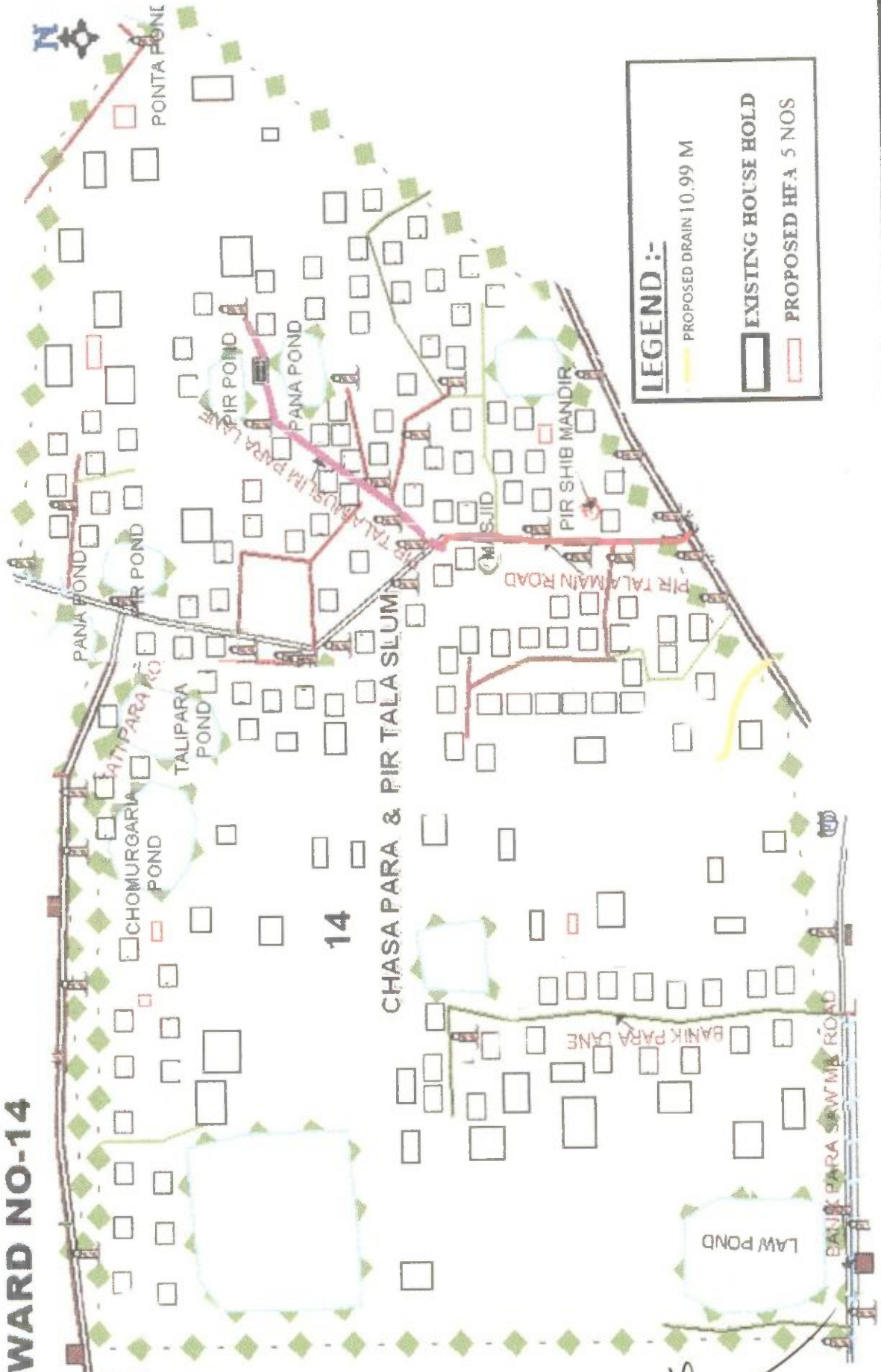
SL. NO. 51



LEGEND :-

- PROPOSED DRAIN 10.99 M
- EXISTING HOUSE HOLD
- PROPOSED HFA 5 NOS

S. A. E.
Kandi Municipality

CHAIRMAN
KANDI MUNICIPALITY



KANDI MUNICIPALITY

BAGDIPARA SLUM(S.C.-038)

WARD NO.-14

BAGDIPARA SLUM

14





Sl. NO. 52

S. A. E.
 Kandi Municipality

[Signature]
 CHAIRMAN
 KANDI MUNICIPALITY

LEGEND:-

-  PROPOSED DRAIN 6.60 M
-  EXISTING HOUSE HOLD
-  PROPOSED H.F.A. 3 NOS

KANDI MUNICIPLITY

Kath gola slum (S.C.-058)

Ward no - 14



LEGEND :-

	PROPOSED DRAIN 6.60 M
	EXISTING HOUSE HOLD
	PROPOSED EFA (3 NOS)

S. A. E.
Kandi Municipality

CHAIRMAN
KANDI MUNICIPALITY

KANDI MUNICIPLITY

Bandherpara slum (S.C.-059)

Ward no - 14



LEGEND :-

- PROPOSED DRAIN
26.38 M
- EXISTING HOUSE HOLD
- PROPOSED HFA 12 NOS

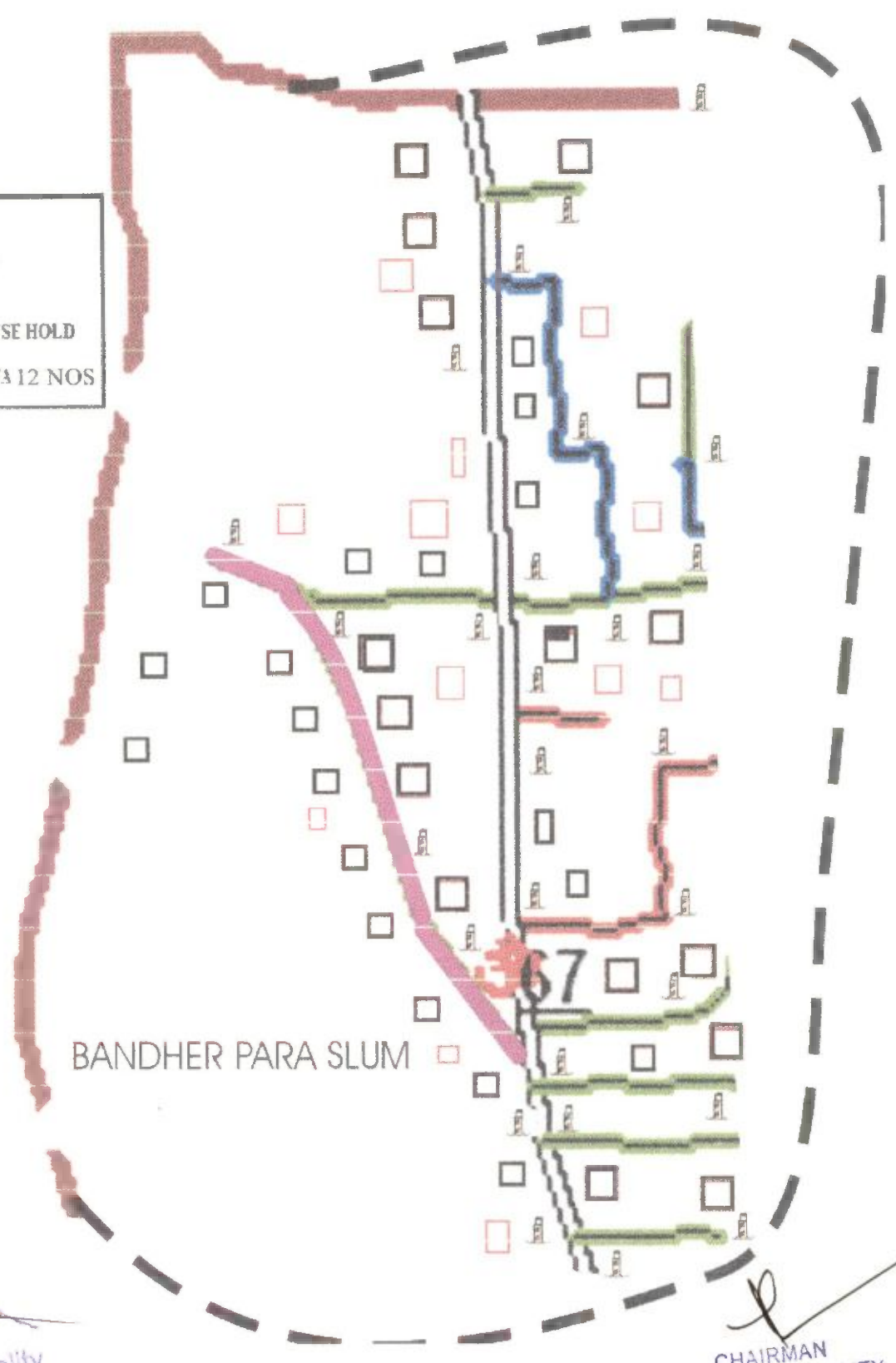

BANDHER PARA SLUM

S.A.E.
Kandi Municipality

[Signature]
CHAIRMAN
KANDI MUNICIPALITY

KANDI MUNICIPLITY HOTEL PARA SLUM (S.C.: 039) WARD NO.-15

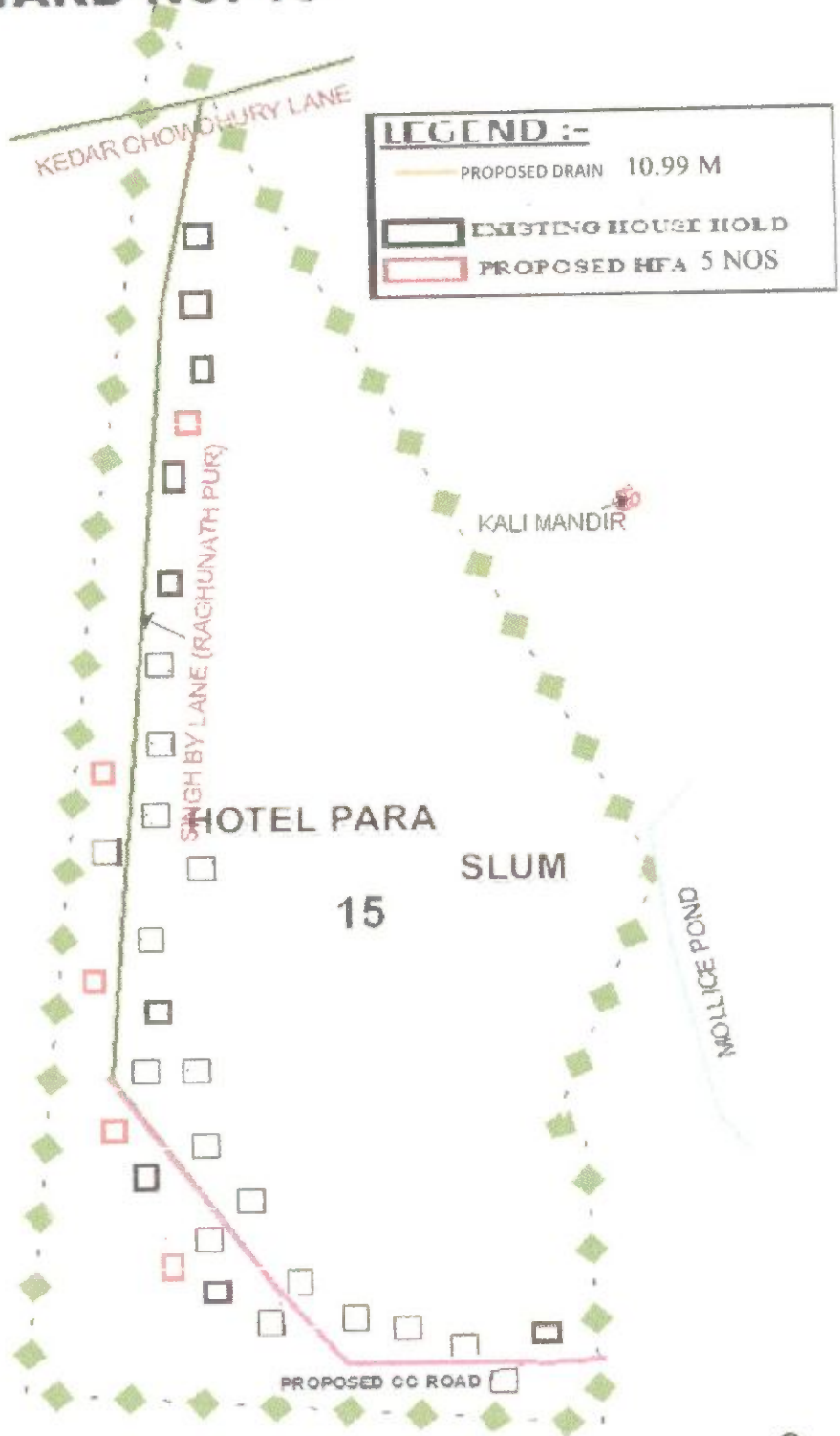

S. A. E.
Kandi Municipality

[Signature]
CHAIRMAN
KANDI MUNICIPALITY



KANDI MUNICIPLITY

Jelopara slum (S.C.-060)

Ward no - 15



LEGEND :-

-  **PROPOSED CC ROAD**
27.43 M
-  **EXISTING HOUSE HOLD**
-  **PROPOSED HFA 4 nos**

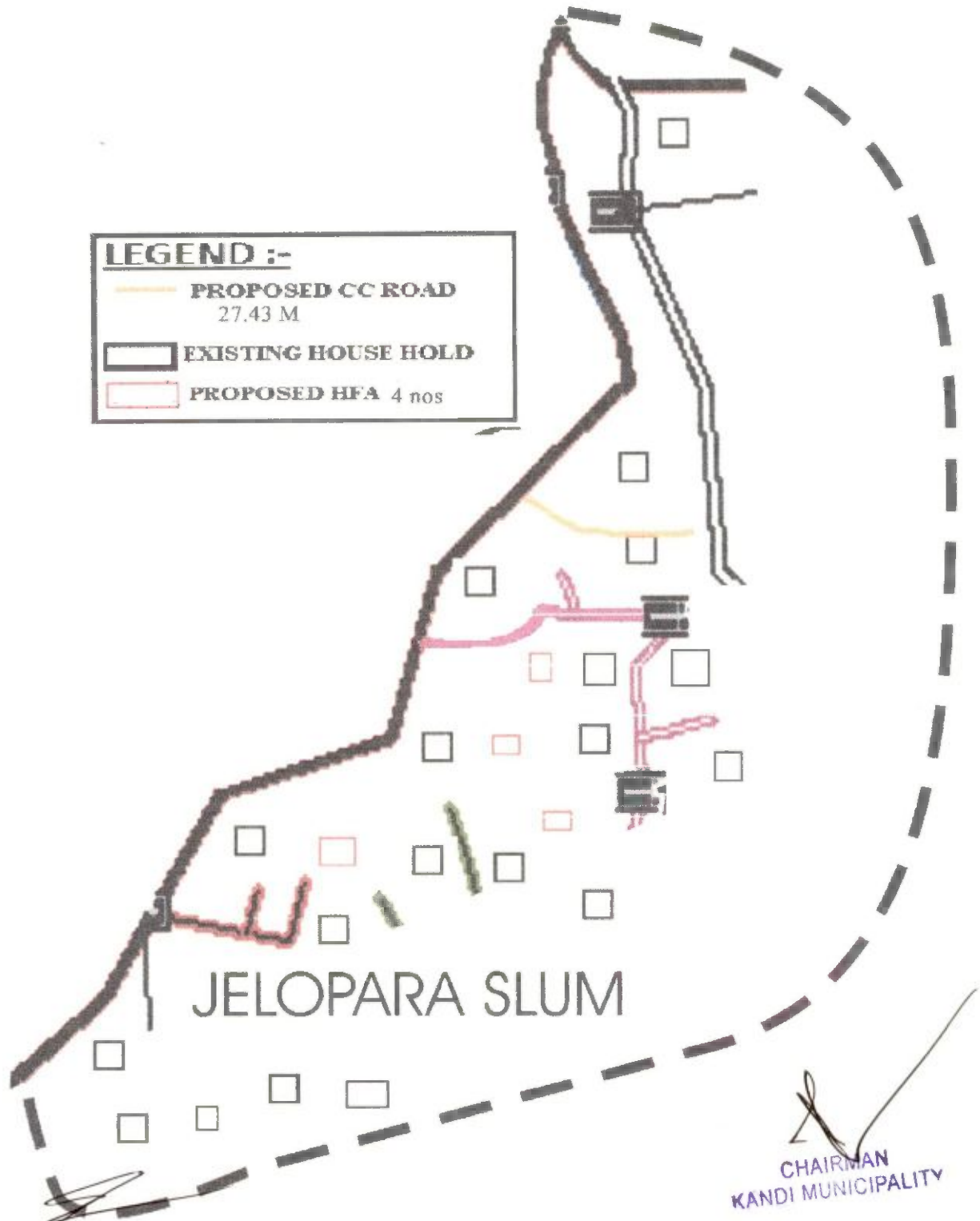

JELOPARA SLUM

S. A. E.
Kandi Municipality

CHAIRMAN
KANDI MUNICIPALITY

KANDI MUNICIPLITY

Coloni Slum NO. -61

Ward no - 15



LEGEND :-

 PROPOSED DRAIN 21.98 M

 EXISTING HOUSE HOLD

 PROPOSED HFA 10 NOS

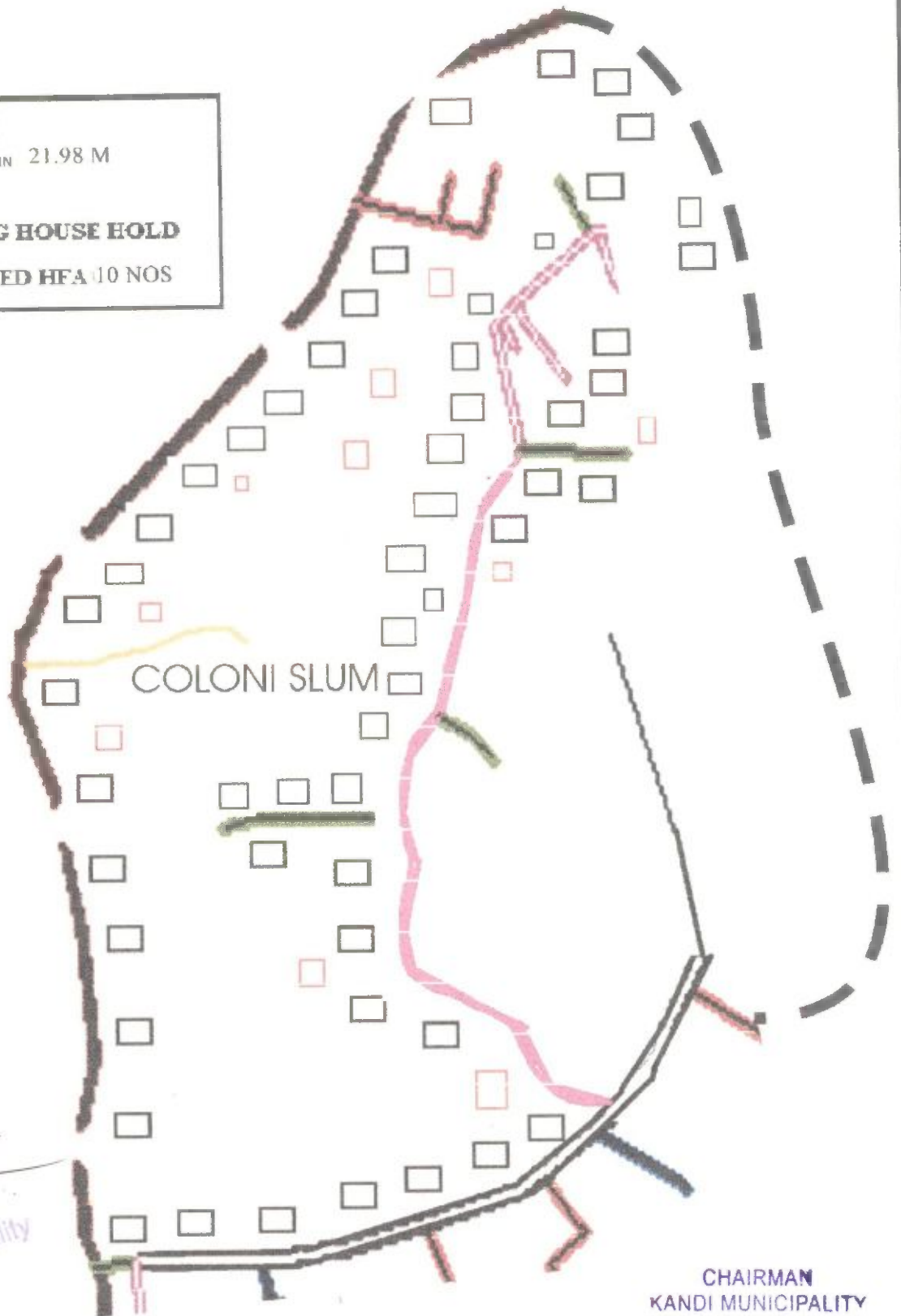



S. A. E.
Kandi Municipality

CHAIRMAN
KANDI MUNICIPALITY

**KANDI MUNICIPALITY
HAZRAPARA SLUM (S.C.:040)
WARD NO.-16**



LEGEND :-

-  PROPOSED DRAIN 21.98 M
-  EXISTING HOUSE HOLD
-  PROPOSED H.H. (10 NOS)

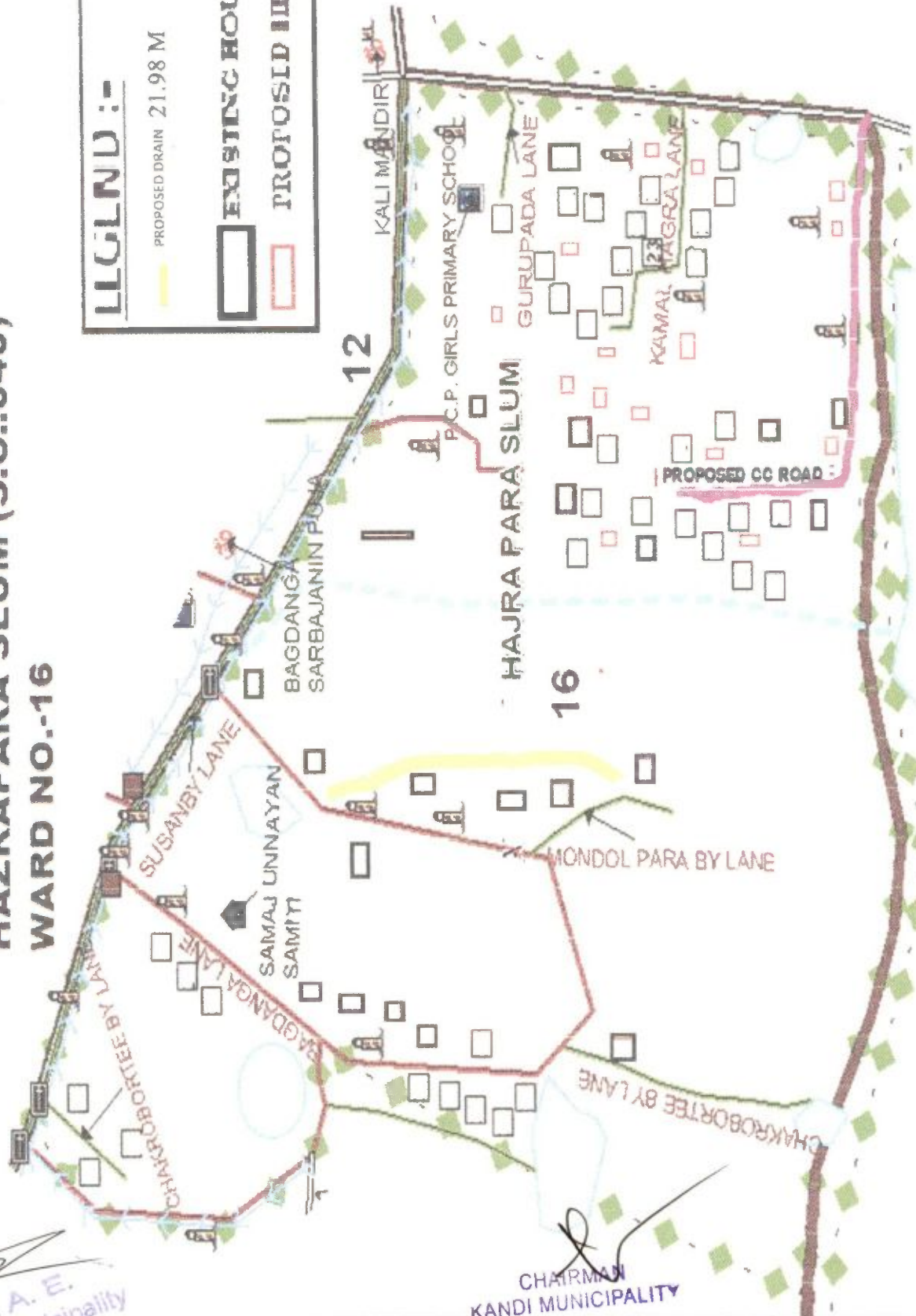

SI. NO. 58

S. A. E.
Kandi Municipality

CHAIRMAN
KANDI MUNICIPALITY



KANDI MUNICIPLITY

Let Konai para slum (S.C.-41)

Ward no - 16



LEGEND :-

-  PROPOSED DRAIN 21.98 M
-  EXISTING HOUSE HOLD
-  PROPOSED HFA 10 NOS)

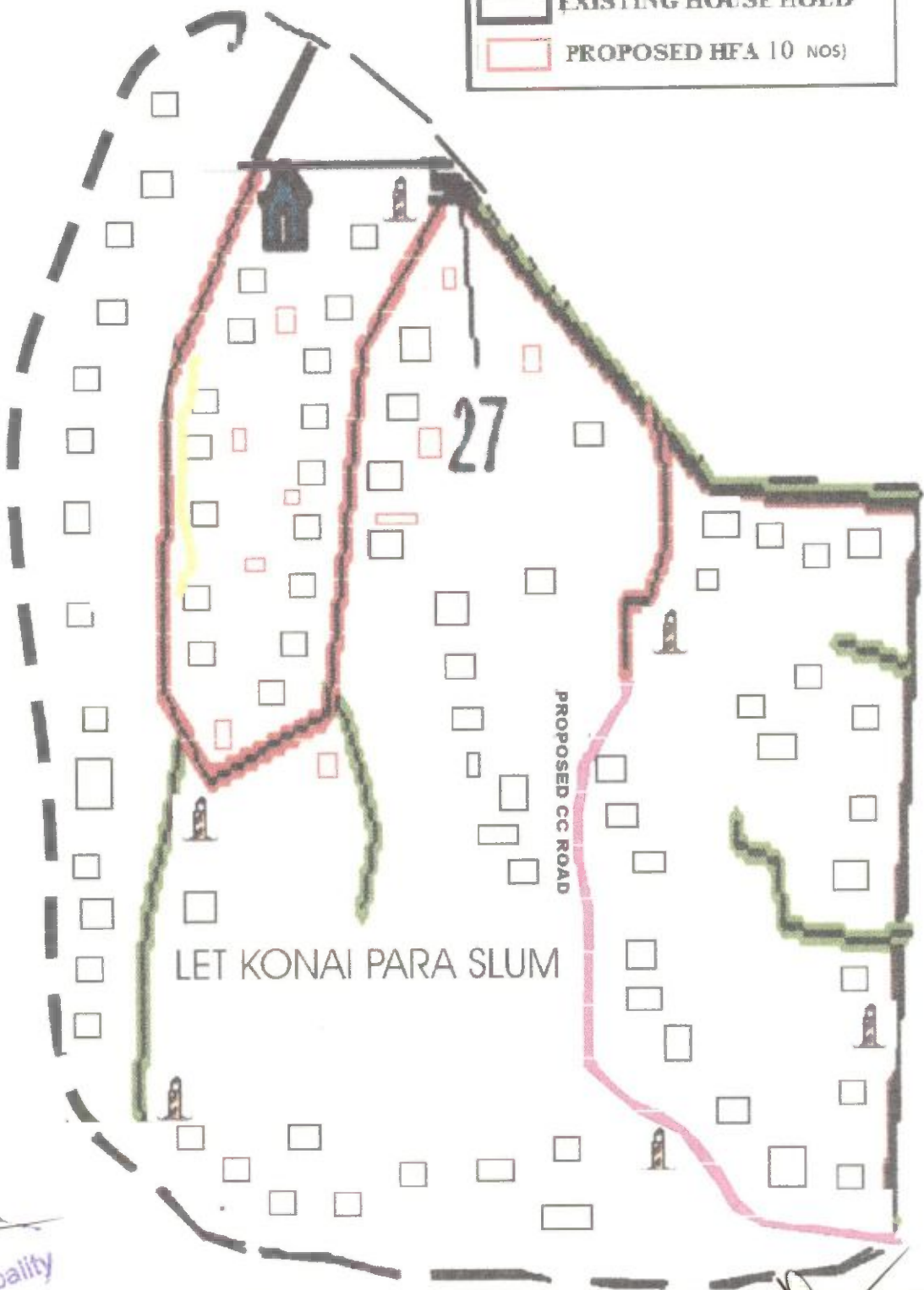

S. A. E.
Kandi Municipality

CHAIRMAN
KANDI MUNICIPALITY

KANDI MUNICIPALITY

Sahispara Slum S.C.: - 42

Ward no-16



LEGEND :-

- PROPOSED DRAIN 21.98 M
- EXISTING HOUSE HOLD
- PROPOSED IIIA (10 NOS)

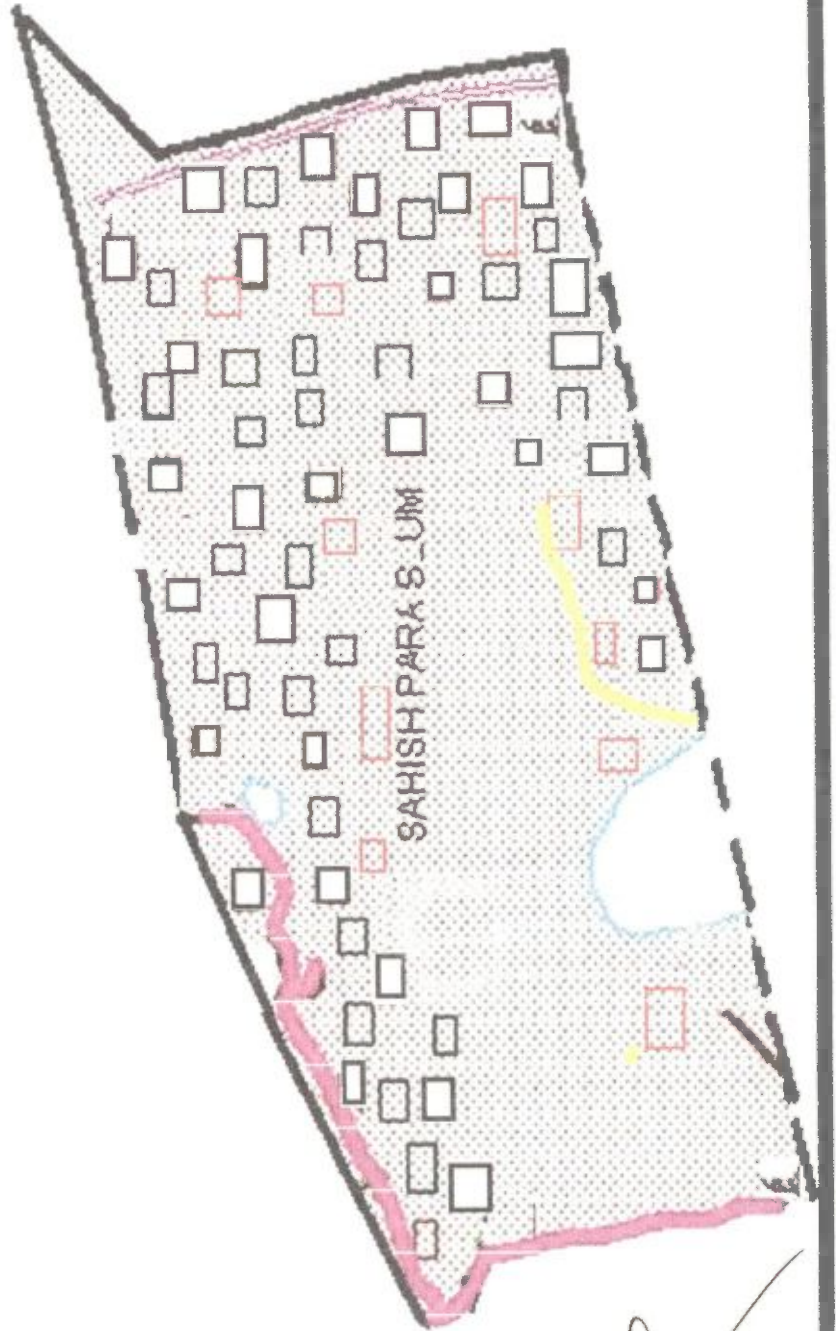

SL. NO. 60



S. A. E.
Kandi Municipality

[Signature]
CHAIRMAN
KANDI MUNICIPALITY

KANDI MUNICIPLITY PRABHAKAR PARA SLUM (S.C.-043), WARD NO.-17



LEGEND :-

-  PROPOSED DRAIN (32.98 M
-  EXISTING HOUSE HOLD
-  PROPOSED HTA (15NOS)

S. A. E.
Kandi Municipality

[Signature]
CHAIRMAN
KANDI MUNICIPALITY



KANDI MUNICIPLITY
BAGDIPARA SLUM(S.C.-038)
WARD NO.- 18

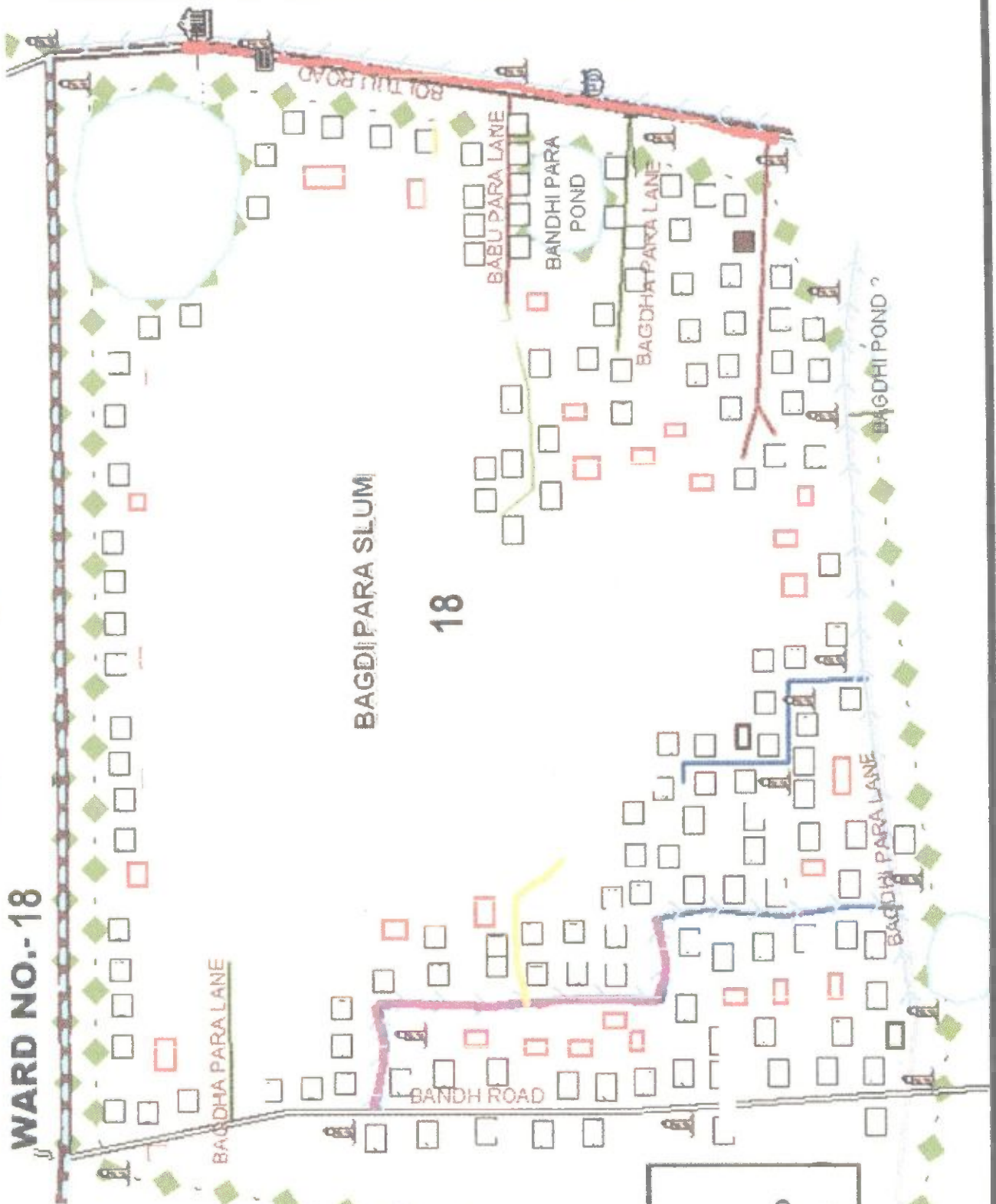

BAGDIPARA SLUM



18

Sl. NO. 52

S. A. E.
 Kandi Municipality

CHAIRMAN
 KANDI MUNICIPALITY

LEGEND :-

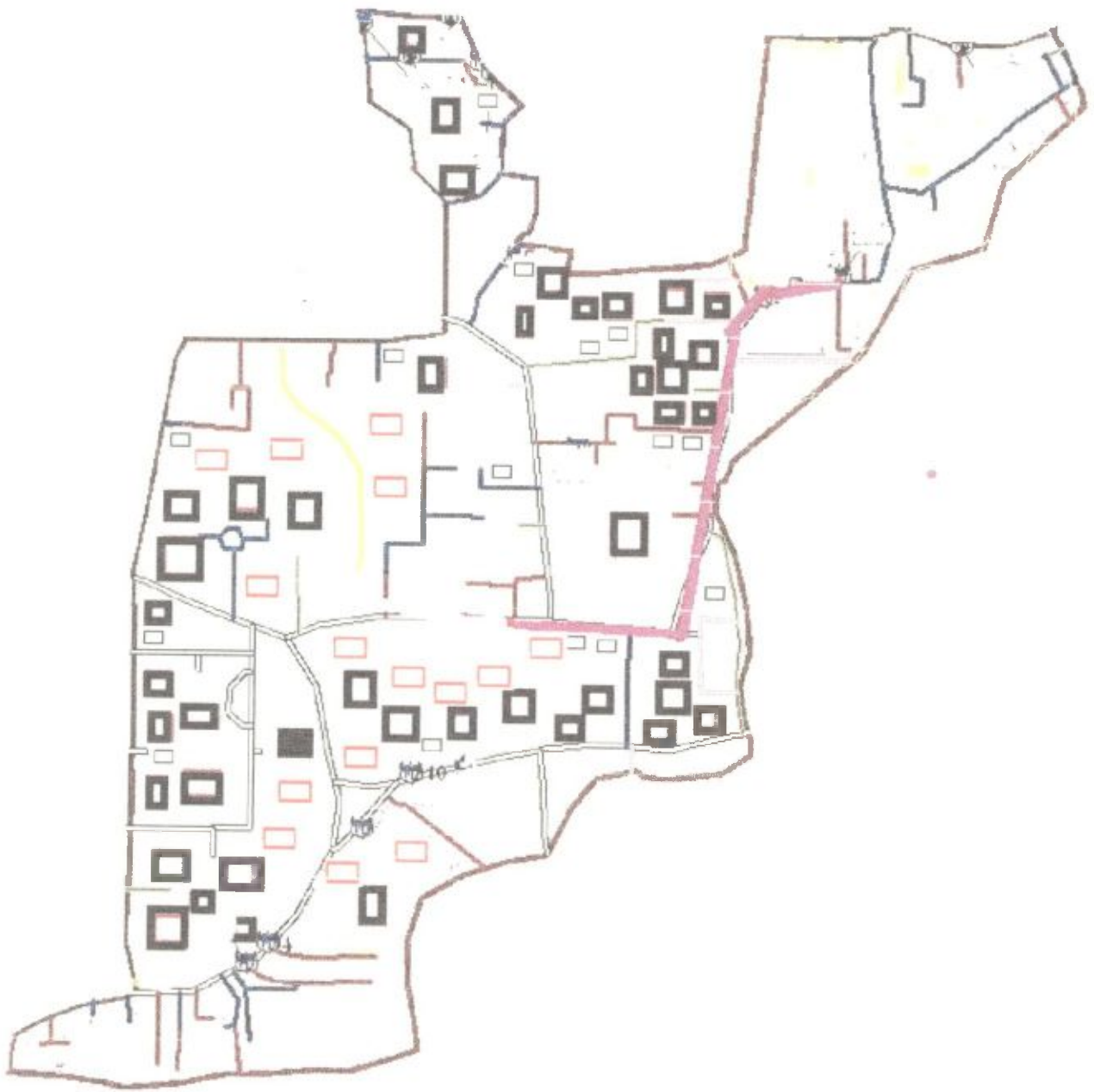

-  PROPOSED DRAIN 70.35 M
-  EXISTING HOUSE HOLD
-  PROPOSED H.F.A 32 nos

WARD NO - 01
KANDI MUNICIPALITY
NON SLUM MAP



S. A. E.
Kandi Municipality

LEGEND :-



-  PROPOSED DRAIN (32.98 M)
-  PROPOSED HOUSE HOLD 15 nos
-  EXISTING HOUSE HOLD

CHAIRMAN
KANDI MUNICIPALITY

WARD NO - 02
KANDI MUNICIPALITY
NON SLUM MAP



S. A. E.
Kandi Municipality

LEGEND :-	
	PROPOSED DRAIN (30.78M)
	EXISTING HOUSE HOLD
	PROPOSED HOUSE HOLD 14 NOS

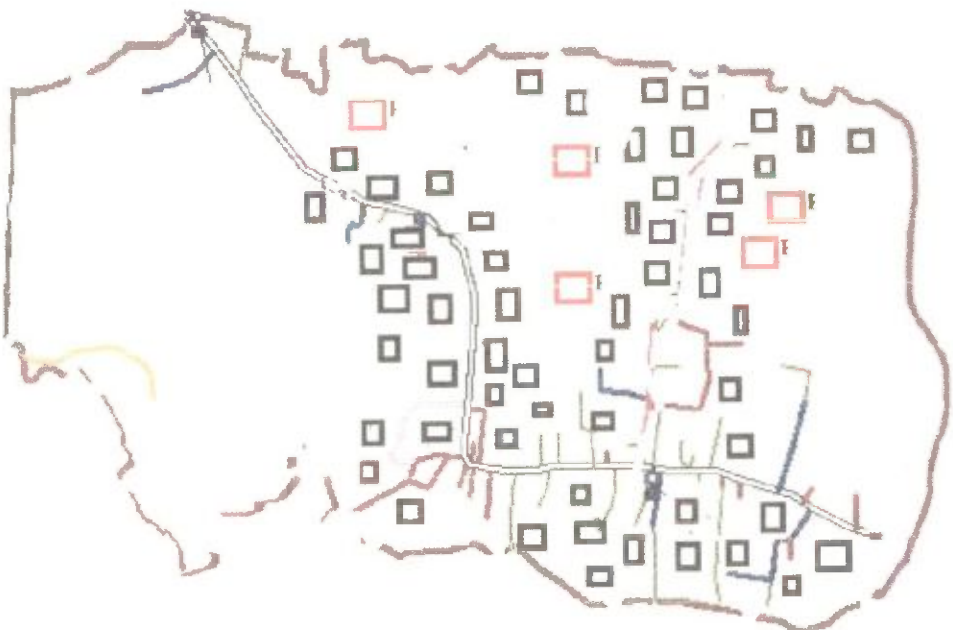

[Signature]
CHAIRMAN
KANDI MUNICIPALITY

WARD NO - 03
KANDI MUNICIPALITY
NON SLUM MAP



S. A. E.
Kandi Municipality

LEGEND :-

-  PROPOSED DRAIN
(10.99 M)
-  EXISTING HOUSE HOLD
-  PROPOSED HOUSE HOLD 5 NOS

CHAIRMAN
KANDI MUNICIPALITY



KANDI MUNICIPALITY
WARD NO-04
NON SLUM MAP

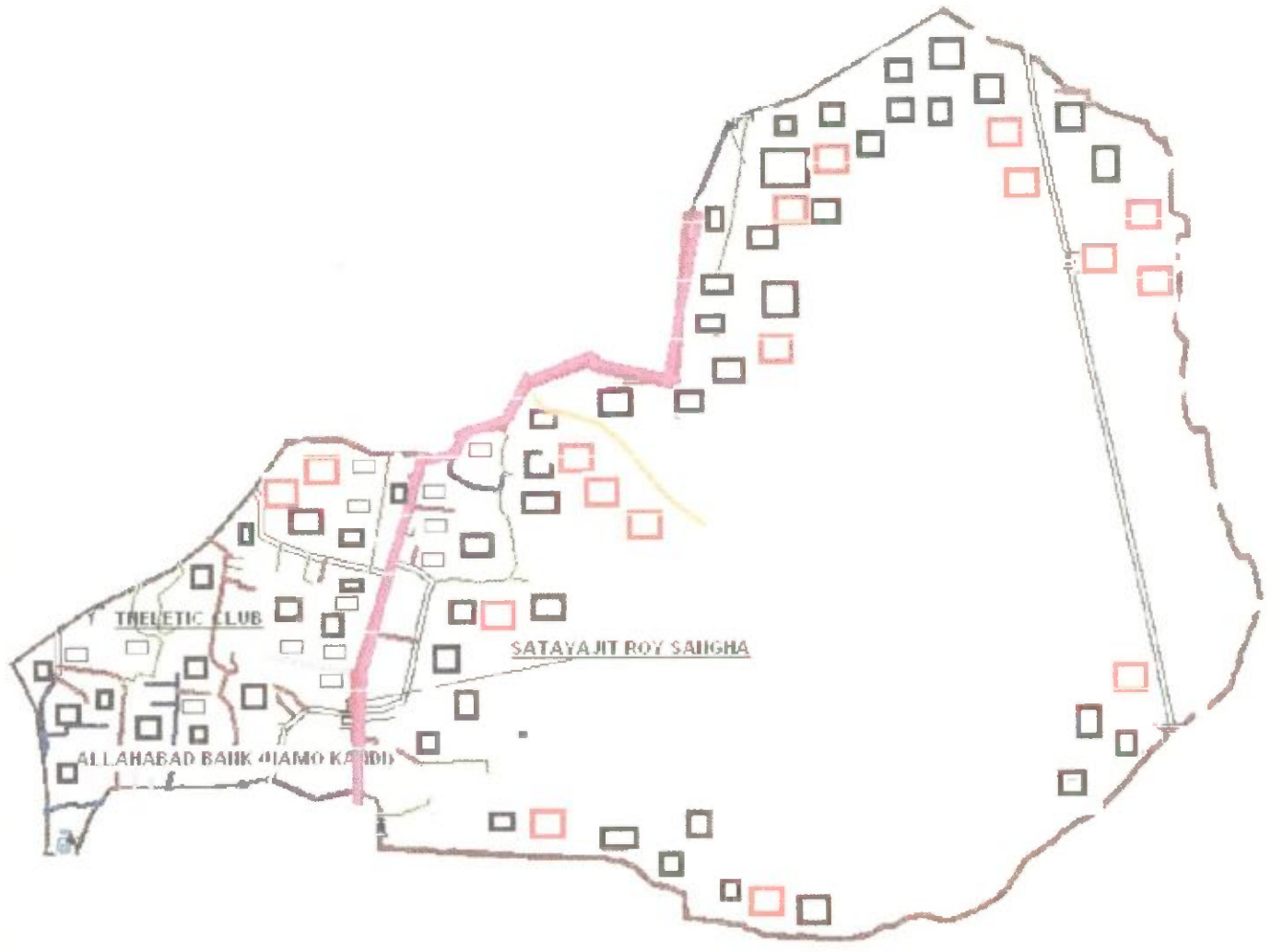

S. A. E.
Kandi Municipality

LEGEND :-

-  PROPOSED DRAIN (39.57M)
-  EXISTING HOUSE HOLD
-  PROPOSED HOUSE HOLD 18 NOS

CHAIRMAN
KANDI MUNICIPALITY

WARD NO - 05
KANDI MUNICIPALITY
NON SLUM MAP

LEGEND

- PROPOSED DRAIN (10.99 MT)
- EXISTING HOUSE HOLD
- PROPOSED HOUSE HOLD 5 NOS

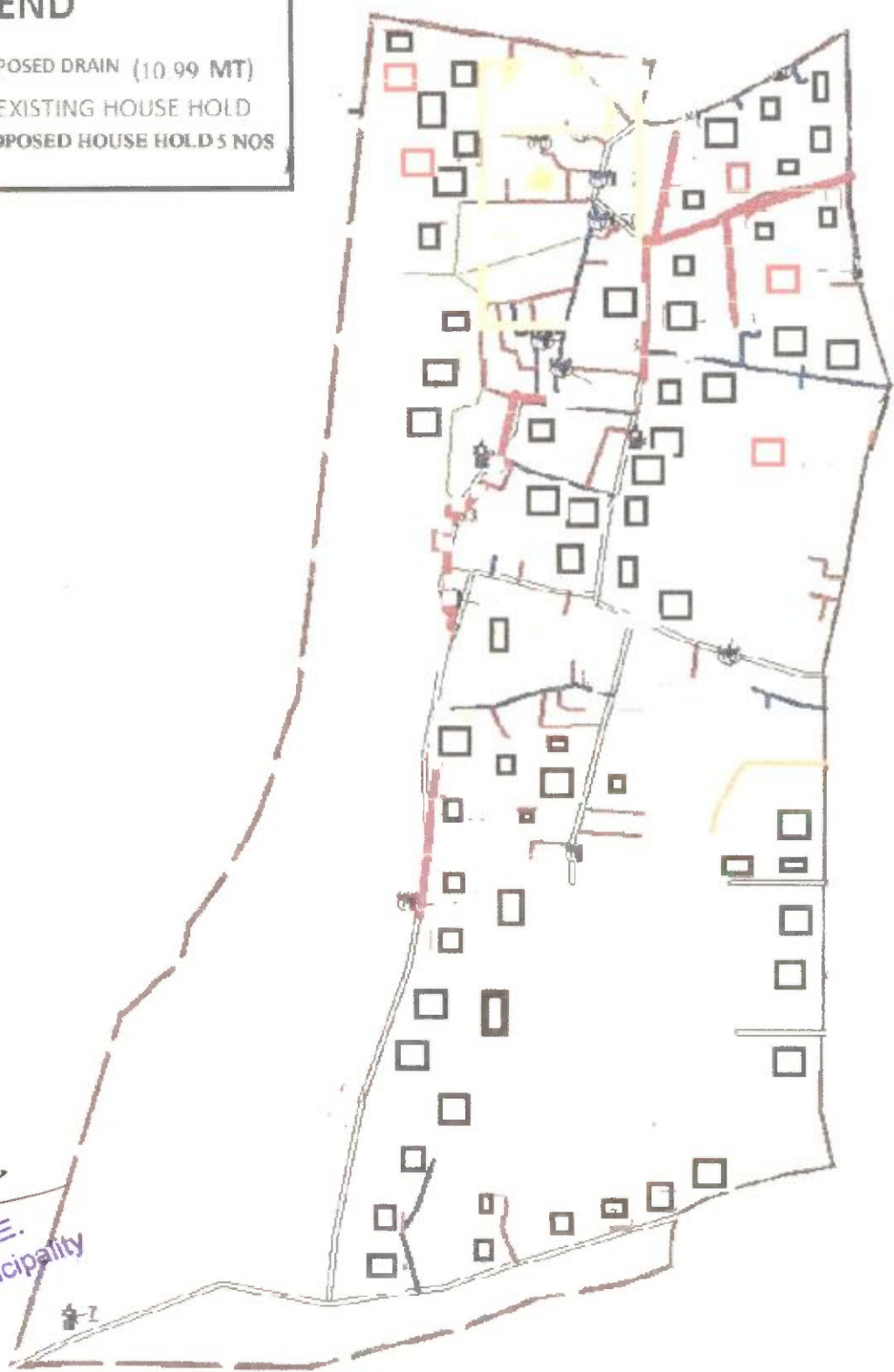



S. A. E.
Kandi Municipality

CHAIRMAN
KANDI MUNICIPALITY

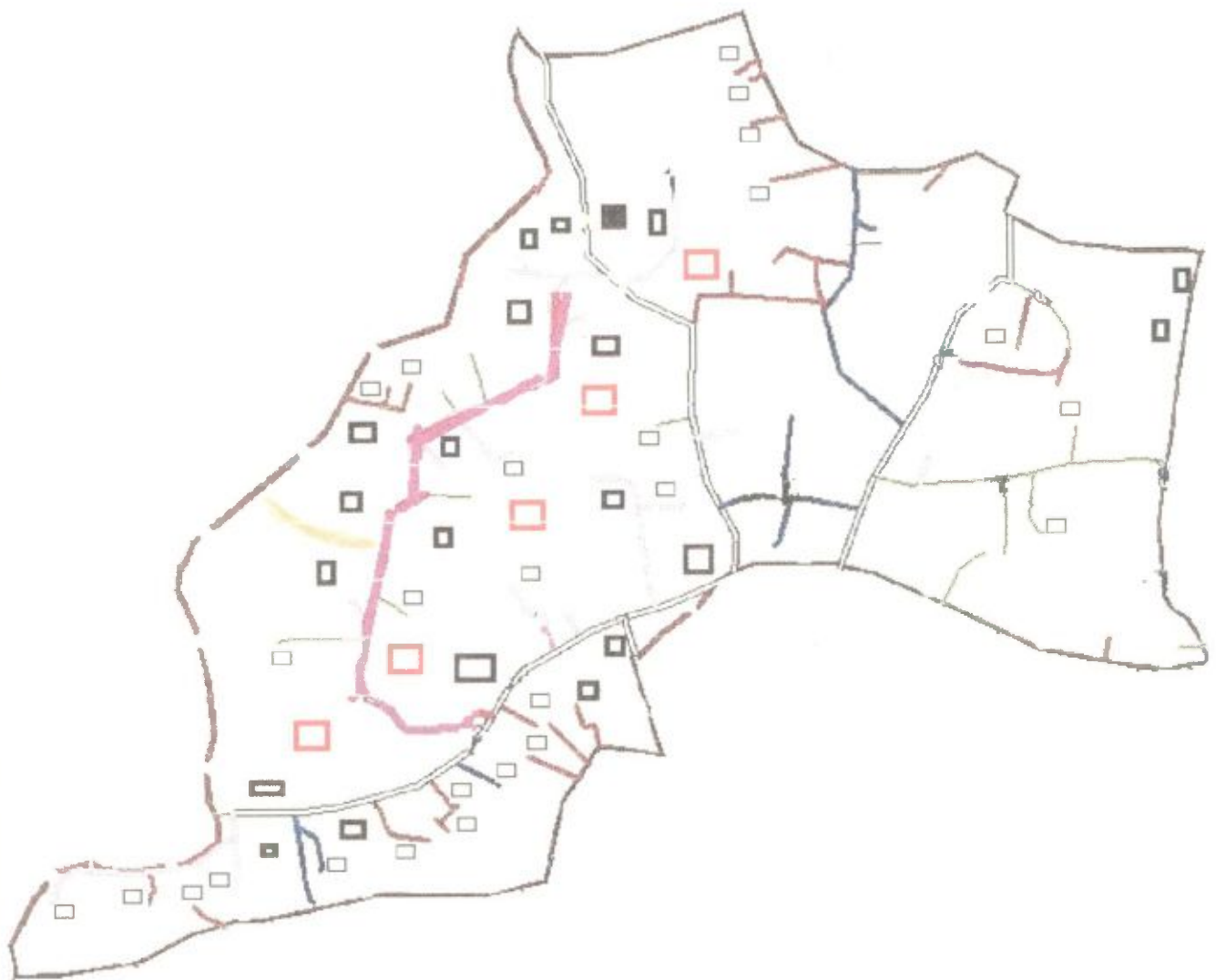
WARD NO - 06
KANDI MUNICIPALITY
NON SLUMI MAP



S. A. E.
Kandi Municipality

LEGEND :-	
	PROPOSED DRAIN (0.99M)
	EXISTING HOUSE HOLD
	PROPOSED HOUSE HOLD 5 NOS

CHAIRMAN
KANDI MUNICIPALITY

WARD NO - 07
KANDI MUNICIPALITY
NON SLUM MAP



LEGEND :-

-  PROPOSED DRAIN
(48.37M)
-  EXISTING HOUSE HOLD
-  PROPOSED HOUSE HOLD 22 NOS



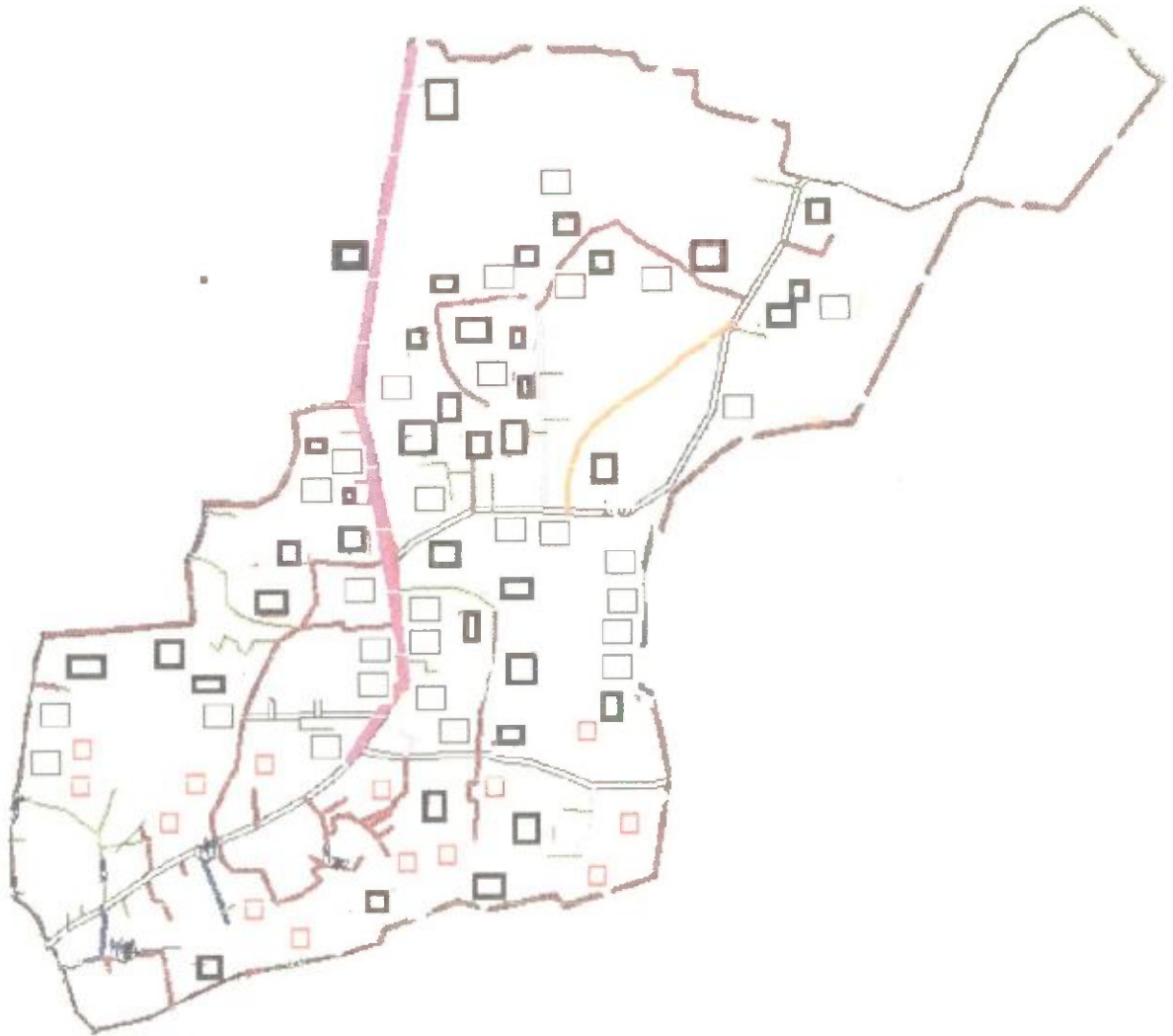

S. A. E.
Kandi Municipality

CHAIRMAN
KANDI MUNICIPALITY

WARD NO - 09
KANDI MUNICIPALITY
NON SLUM MAP



LEGEND :-

-  PROPOSED DRAIN
(30.78M)
-  EXISTING HOUSE HOLD
-  PROPOSED HOUSE HOLD 14 NOS



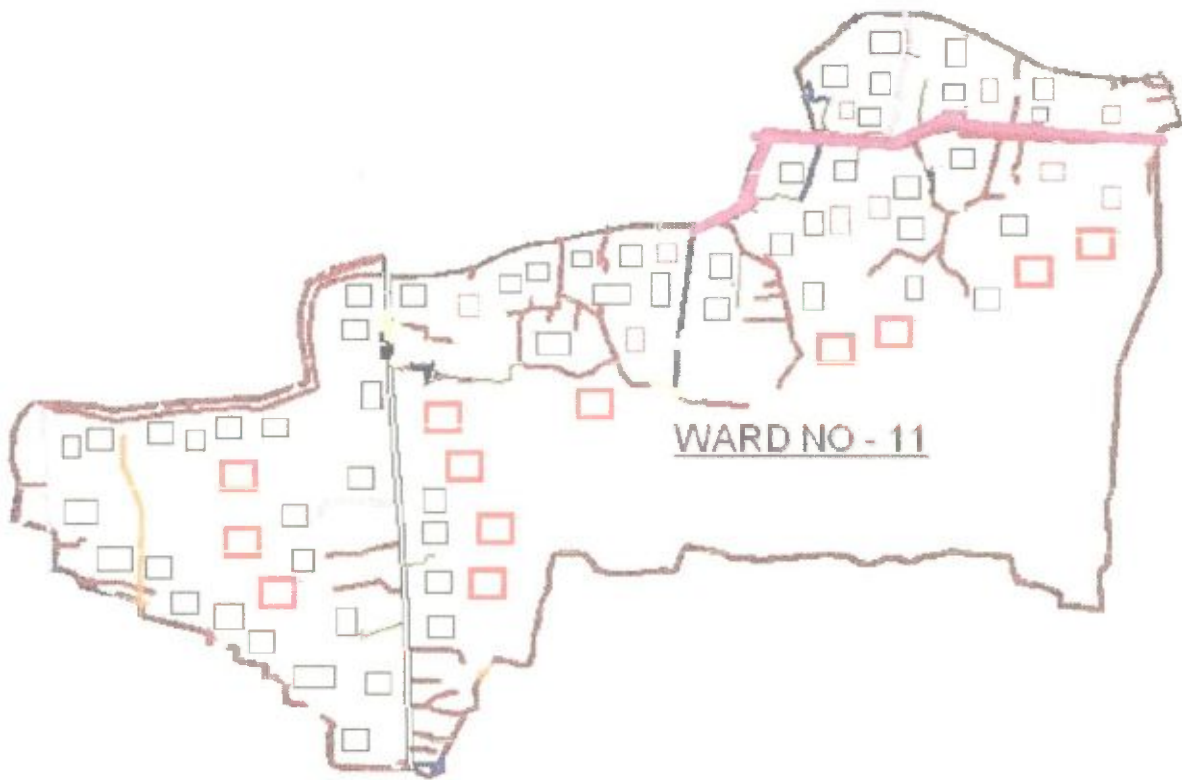

CHAIRMAN
KANDI MUNICIPALITY

WARD NO - 11
KANDI MUNICIPALITY
NON SLUM MAP



S. A. E.
Kandi Municipality

LEGEND :-



	PROPOSED DRAIN (26.38M)
	EXISTING HOUSE HOLD
	PROPOSED HOUSE HOLD 12 NOS

S. A. E.
CHAIRMAN
KANDI MUNICIPALITY

WARD NO - 12
KANDI MUNICIPALITY
NON SLUM MAP



LEGEND :-

-  PROPOSED DRAIN
(21.98 M²)
-  EXISTING HOUSE HOLD
-  PROPOSED HOUSE HOLD 10 NOS



S. A. E.
Kandi Municipality

[Signature]
CHAIRMAN
KANDI MUNICIPALITY

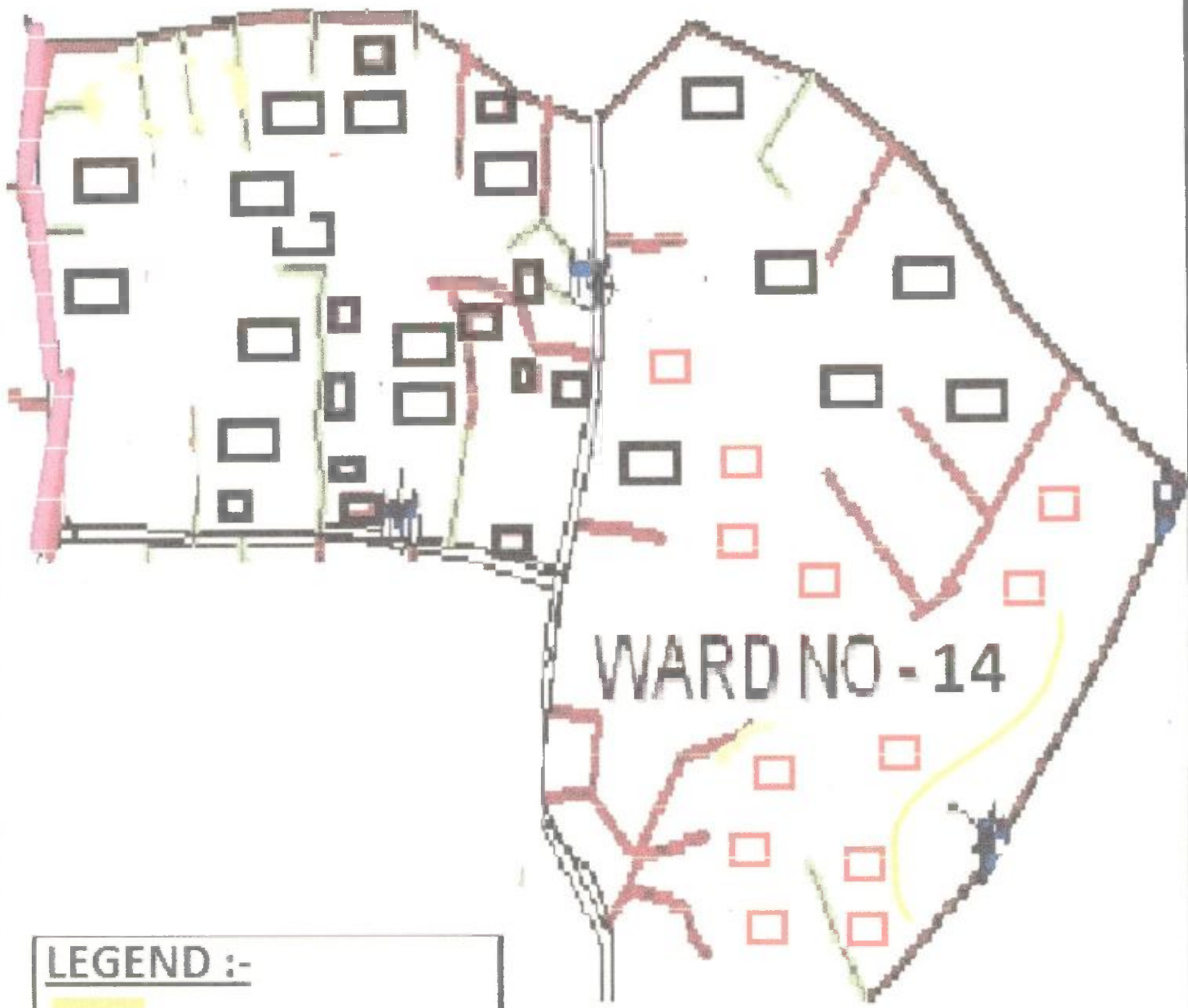
WARD NO - 14
KANDI MUNICIPALITY
NON SLUM MAP



LEGEND :-

-  PROPOSED DRAIN (26.38M)
-  EXISTING HOUSE HOLD
-  PROPOSED HOUSE HOLD 12 NOS



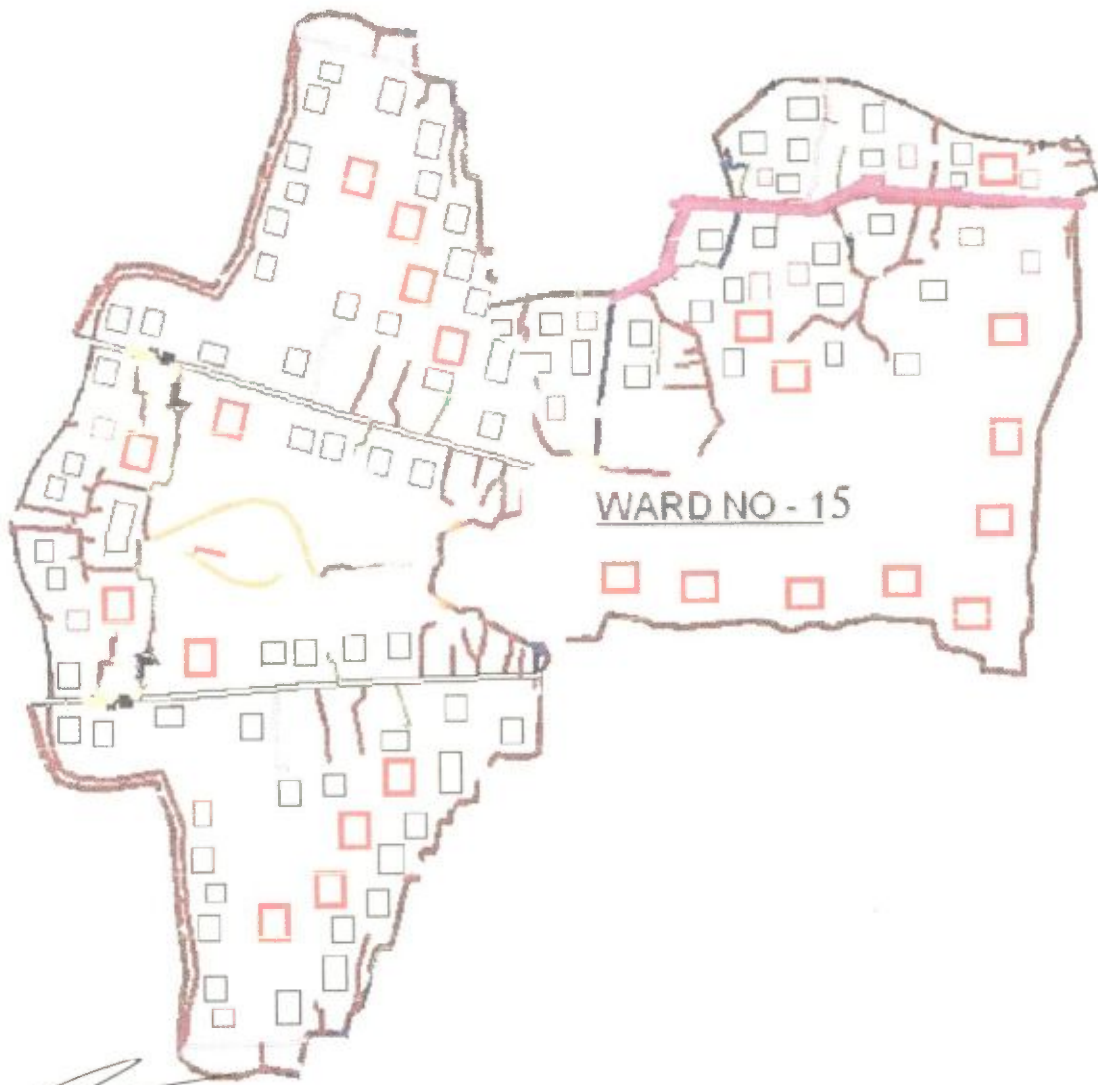

S. A. E.
Kandi Municipality

CHAIRMAN
KANDI MUNICIPALITY

WARD NO - 15
KANDI MUNICIPALITY
NON SLUM MAP



LEGEND :-

-  PROPOSED DRAIN
41.77 M
-  EXISTING HOUSE HOLD
-  PROPOSED HOUSE HOLD 19 NOS



S.A.E.
Kandi Municipality

[Signature]
CHAIRMAN
KANDI MUNICIPALITY

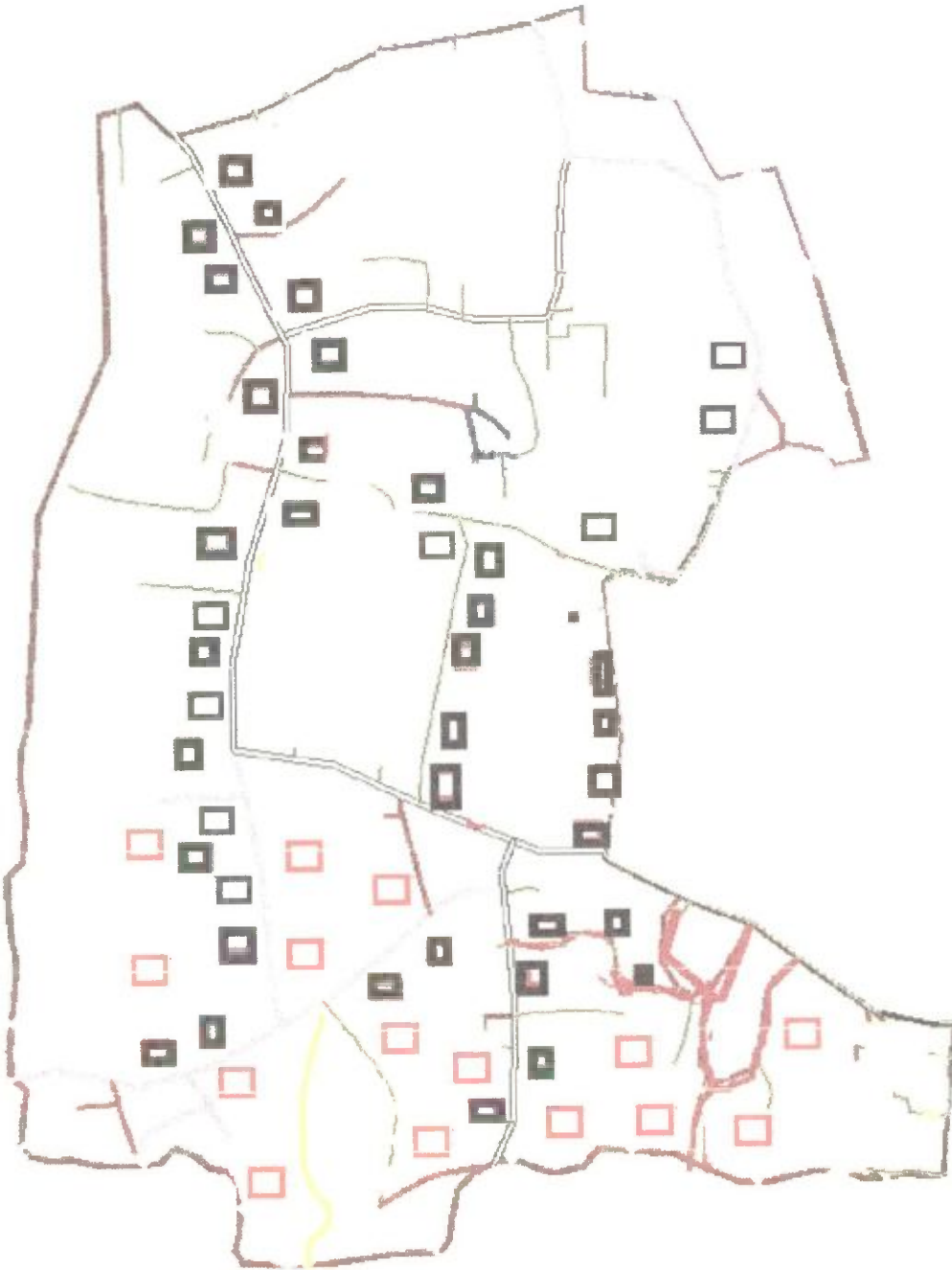
WARD NO - 16
KANDI MUNICIPALITY
NON SLUM MAP



LEGEND :-

-  PROPOSED DRAIN
- (32.99MT)
-  EXISTING HOUSE HOLD
-  PROPOSED HOUSE HOLD 15 NOS

S. A. F.
Kandi Municipality

CHAIRMAN
KANDI MUNICIPALITY

WARD NO - 17
KANDI MUNICIPALITY
NON SLUM MAP



LEGEND :-

-  PROPOSED DRAIN (15.39M)
-  EXISTING HOUSE HOLD
-  PROPOSED HOUSE HOLD 7 NOS

S. A. E.
Kandi Municipality

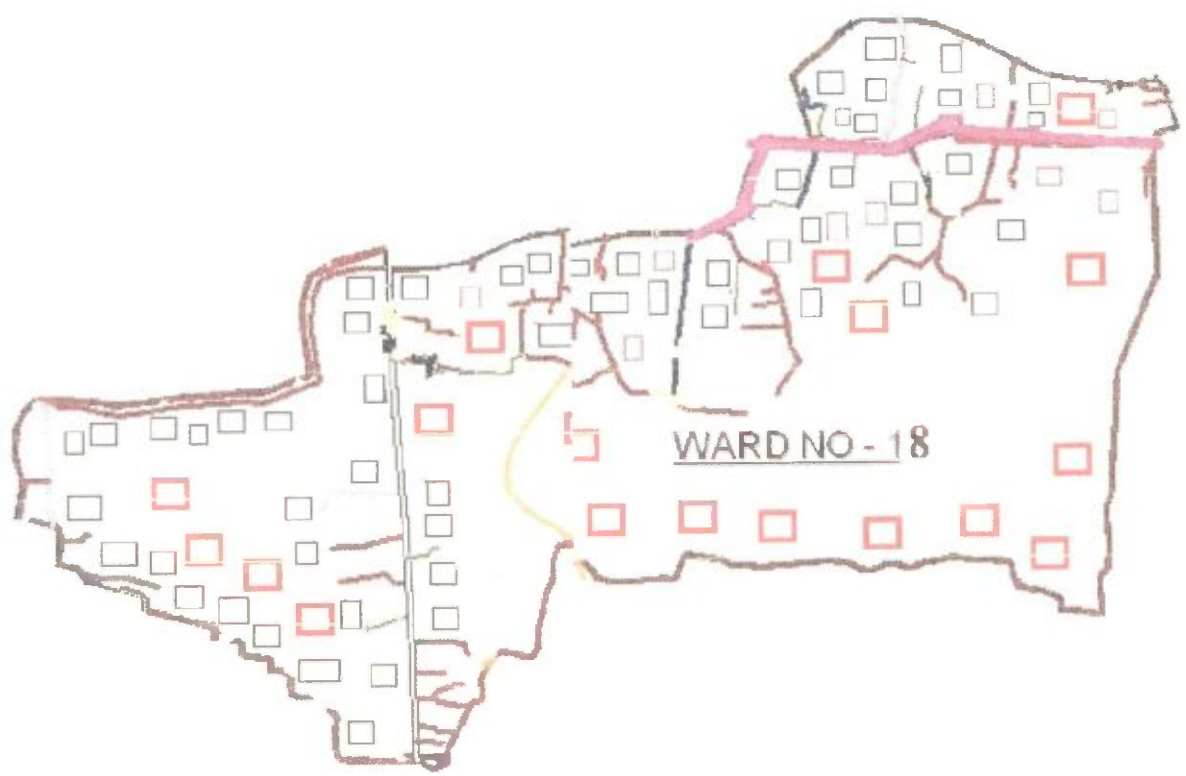

CHAIRMAN
KANDI MUNICIPALITY

WARD NO - 18
KANDI MUNICIPALITY
NON SLUM MAP



S. A. E.
Kandi Municipality

LEGEND :-









-  PROPOSED DRAIN
(39.57M)
-  EXISTING HOUSE HOLD
-  PROPOSED HOUSE HOLD 18 NOS

[Signature]
CHAIRMAN
KANDI MUNICIPALITY



BENEFICIARY LIST

PMAY (HFA- 2019-20)

BENEFICIARY LIST OF KANDI MUNICIPALITY

Sl. No.	Ward No	SLUM /Non Slum	Name of Beneficiary	Father's Name / Husband's Name	Holding No./Address	Category		Gender	Adhaar No.	Mob No.	Photo
						General/S.C./O.B. C./S.T	Minority				
1	1	MOHANBAGA NEAST	FAJELA BIBI	LATE OHAB SK	89/89	GENERAL	Minority	F	87085290354	9732402116	
2	1	MOHANBAGA NEAST	ANOWARA KHATUN	MONIRUJJAMAN	80/95	GENERAL	Minority	F	229173086769	9614019785	
3	1	MOHANBAGA NEAST	MALIYAT SK	BADSHA SK	NEW -80/20	GENERAL	Minority	M	522125153268	7864056746	
4	1	MOHANBAGA NEAST	SAKILA BIBI	PATAL SEKH	20/44	GENERAL	Minority	F	609148941976	6295798985	
5	1	MOHANBAGA NEAST	ATAI BIBI	LATE FIROT SK	7/46/B	GENERAL	Minority	F	478221601647	9564703784	
6	1	MOHANBAGA NEAST	RAHIM SEIKH	LATE ZUHAD SEIKH	80/24	GENERAL	Minority	M	307840534232	6295096455	
7	1	MOHANBAGA NEAST	SAMSUL ALI	FANU SK	53/66	GENERAL	Minority	M	354796489408	9647379656	
8	1	MOHANBAGA NEAST	MARIYAM BIBI	ABU BAKKAR SK	10/1/1980	GENERAL	Minority	F	404454572744	8348191044	









 CHAIRMAN
 KANDI MUNICIPALITY

Sl. No.	Ward No	SLUM /Non Slum	Name of Beneficiary	Father's Name / Husband's Name	Holding No./Address	Category		Gender	Adhaar No.	Mob No.	Photo
						General/S.C./O.B. C./S.T	Minority				
9	1	MOHANBAGA N EAST	SUNIL CHATTOPADHYAY	LATE KRISHNA KANTI CHATTOPADHYAY	SCHOOL ROAD	GENERAL	NO	M	253149489441	9474708330	
10	1	MOHANBAGA N EAST	BRINDABAN DAS	LT RADHASHYAM DAS	CHASAPARA	GENERAL	NO	MALE	326093108600	6289228617	



 CHAIRMAN
 KANDI MUNICIPALITY

PMAY (HFA- 2019-20)

BENEFICIARY LIST OF KANDI MUNICIPALITY

Sl. No.	Ward No	SLUM /Non Slum	Name of Beneficiary	Father's Name / Husband's Name	Holding No./Address	Category		Gender	Adhaar No.	Mob No.	Photo
						General/S.C./O.B. C./S.T	Minority				
1	1	HAZRAPARA SLUM	GOBINDO HAZRA	AKSHAY HAZRA	HAZRAPARA	SC	NO	MALE	748799374394	9664456474	
2	1	HAZRAPARA SLUM	ACHINTA HAZRA	MRITYUNJOY HAZRZ	HAZRAPARA	SC	NO	MALE	681792567044	7797772544	
3	1	HAZRAPARA SLUM	RANJIT HAZRA	LT. SHANTI HAZRA	HAZRAPARA	SC	NO	MALE	410515673315	9693046725	
4	1	HAZRAPARA SLUM	AJOY HAZRA	LT. ABANI HAZRA	HAZRAPARA	SC	NO	MALE	340810927723	9933665663	
5	1	HAZRAPARA SLUM	ASHOKA KONAI	KASHINATH KONAI	HAZRAPARA	SC	NO	FEMALE	272971112492	8617864728	
6	1	HAZRAPARA SLUM	BANU BARIK	LT. AYAN BARIK	HAZRAPARA	SC	NO	MALE	775049946666	9635483726	
7	1	HAZRAPARA SLUM	GANGADHAR HAZRA	BABURAM HAZRA	HAZRAPARA	SC	NO	MALE	224026805048	9002197457	
8	1	HAZRAPARA SLUM	SATINATH HAZRA	MANTU HAZRA	HAZRAPARA	SC	NO	MALE	937987105411	9733730186	









 CHAIRMAN
 KANDI MUNICIPALITY

Sl. No.	Ward No	SLUM /Non Slum	Name of Beneficiary	Father's Name / Husband's Name	Holding No./Address	Category		Gender	Adhaar No.	Mob No.	Photo
						General/S.C./O.B. C./S.T	Minority				
9	1	HAZRAPARA SLUM	SRIMANTA SINHA	BHABANI CHARAN SINHA	DHALLAPARA	GEN	NO	MALE	641805798346	7001089826	
10	1	HAZRAPARA SLUM	DIPANKAR SINHA	LT. PRADIP KUMAR SINHA	DHALLAPARA	GEN	NO	MALE	548614267320	8250420842	









 CHAIRMAN
 KANDI MUNICIPALITY

PMAY (HFA- 2019-20)

BENEFICIARY LIST OF KANDI MUNICIPALITY

Sl. No.	Ward No	SLUM /Non Slum	Name of Beneficiary	Father's Name / Husband's Name	Holding No./Address	Category		Gender	Adhaar No.	Mob No.	Photo
						General/S.C./O.B. C./S.T	Minority				
1	1	MOHANBAGA N WEST	RONU SK	HANU SK	4/50	GENERAL	Minority	M	847889386826	7001089772	
2	1	MOHANBAGA N WEST	MAJIDA BIBI	LATE BADAR SK	33/82	GENERAL	Minority	F	896935645435	08689861637	
3	1	MOHANBAGA N WEST	JAHERUNNESA BEGUM	AZIMUDDIN AHAMED	13/10/A	GENERAL	Minority	F	262824985103	8597737328	
4	1	MOHANBAGA N WEST	TOHINUR KHATUN	LATE TUTUN SK	23/40	GENERAL	Minority	F	647515389537	8101388746	
5	1	MOHANBAGA N WEST	JELDAR SK	LATE ANESUDDIN SK	5/53	GENERAL	Minority	M	566402352319	7872423385	
6	1	MOHANBAGA N WEST	MANURUDDIN SK	LATE CHOPED SK	28/1	GENERAL	Minority	M	889982465910		
7	1	MOHANBAGA N WEST	EKER ALI SK	LATE YAZUDDIN SK	30/2	GENERAL	Minority	M	395740645622		
8	1	MOHANBAGA N WEST	JAKERA BIBI	LATE JABER ALI SK	24/33	GENERAL	Minority	F	564051332311	9775028576	







CHAIRMAN
KANDI MUNICIPALITY

Sl. No.	Ward No	SLUM /Non Slum	Name of Beneficiary	Father's Name / Husband's Name	Holding No./Address	Category		Gender	Adhaar No.	Mob No.	Photo
						General/S.C./O.B. C./S.T	Minority				
9	1	MOHANBAGA N WEST	HALIM SK	SALAMOT SK	18/20	GENERAL	Minority	M	207481122523	7001160784	
10	1	MOHANBAGA N WEST	CHAMPA BIBI	MILAN SEKH	46/B/13	GENERAL	Minority	F	561320816677		
11	1	MOHANBAGA N WEST	JAHUR SK	MANURUDDIN SK	3/90	GENERAL	Minority	M	788384885833	6295323610	
12	1	MOHANBAGA N WEST	MEHERUN BIBI	SWAPAN SK	8/20	GENERAL	Minority	F	955557374235		
13	1	MOHANBAGA N WEST	JESHMIN KHATUN (KHAN)	MONIR KHAN	44124	O B C	Minority	F	741600365425	7044475291	
14	1	MOHANBAGA N WEST	DONA AHAMED	NASIRUDDIN AHAMED	13/A/7	GENERAL	Minority	F	618390761228	8918433669	
15	1	MOHANBAGA N WEST	TUSHAR KANTI DHAR	LATE JAPENDRA NARAYAN DHAR	BISHRAMTALA	GENERAL	NO	M	501069376213	9614404477	

 CHAIRMAN
 KANDI MUNICIPALITY

PMAY (HFA. 2019-20)





BENEFICIARY LIST OF KANDI MUNICIPALITY

Sl. No.	Ward No	SLUM /Non Slum	Name of Beneficiary	Father's Name / Husband's Name	Holding No./Address	Category		Gender	Adhaar No.	Mob No.	Photo
						General/S.C./O.B. C./S.T	Minority				
1	2	KALABAGAN	MALAY DAS	LT. ALOKE DAS	KANDI KALABAGAN	GENERAL	NO	M	219146747171	9735693819	
2	2	KALABAGAN	MANIK CHANDRA SAHA	LT. DHANANJOY SAHA	KANDI KALABAGAN	GENERAL	NO	M	524568354034	7602302666	
3	2	KALABAGAN	NILKANTA ROY	LT. HARIPADA ROY	KANDI KALABAGAN	GENERAL	NO	M	542074154643	9434363401	
4	2	KALABAGAN	PANCHANAN DALUI	LT. KASHI DALUI	KANDI KALABAGAN	SC	NO	M	968972372708	9475202258	
5	2	KALABAGAN	SUKHEN DALUI	LT. SHIVNATH DALUI	KANDI KALABAGAN	SC	NO	M	468580342041	8768289976	
6	2	NON SLUM	SASANKA MONDAL	LT. GOPAL MONDAL	KANDI KALABAGAN	GENERAL	NO	M	222875709485	9333252423	

 CHAIRMAN
 KANDI MUNICIPALITY

PMAY (HFA- 2019-20)





BENEFICIARY LIST OF KANDI MUNICIPALITY

Sl. No.	Ward No	SLUM/Non Slum	Name of Beneficiary	Father's Name / Husband's Name	Holding No./Address	Category		Gender	Adhaar No.	Mob No.	Photo
						General/S.C./O.B. C./S.T	Minority				
1	3	BOLTALA (005)	POLIBHANDARI DAS	SANJIB DAS	KANDI JIBDHARPARA	O B C	NO	F	205840865519	9733746401	
2	3	BOLTALA (005)	SUBRATA BITTEL	RAKSHAKAR BITTEL	KANDI JIBDHARPARA	S C	NO	M	95250152206		
3	3	BOLTALA (005)	RAJIB BANERJEE	DILIP BANERJEE	KANDI JIBDHARPARA	GENERAL	NO	M	352669457382	9547938259	
4	3	BOLTALA (005)	JHUMA DAS	BIREN DAS	KANDI JIBDHARPARA	S C	NO	F	458226519689	8159933917	
5	3	BOLTALA (005)	ANIL KUMAR MONDAL	LATE RADHAKANTA MONDAL	KANDI DHALLAPARA	GENERAL	NO	M	587458294687	96099234929	

CHAIRMAN
KANDI MUNICIPALITY

PMAY (HFA- 2019-20)





BENEFICIARY LIST OF KANDI MUNICIPALITY

Sl. No.	Ward No	SLUM /Non Slum	Name of Beneficiary	Father's Name / Husband's Name	Holding No./Address	Category		Gender	Adhaar No.	Mob No.	Photo
						General/S.C./O.B.C./S.T	Minority				
1	3	TARAMATALA (045)	BHADRA HAZRA	GANGA HAZRA	KANDI DHALLAPARA	SC	NO	F	650063958284	9800224251	
2	3	TARAMATALA (045)	BISHNU PATRA	SAYANI PATRA	KANDI JIBDHARPARA	O.B.C.	NO	M	912307973964	9679097440	
3	3	TARAMATALA (045)	ANIRUDDHA ROY	SHIBNARAYAN ROY	KANDI DHALLAPARA	GENERAL	NO	M	441240312243	8906091860	
4	3	TARAMATALA (045)	RUDRANATH DUTTA	BISWANATH DUTTA	KANDI DHALLAPARA	GENERAL	NO	M	750109278337	9432814611	

 CHAIRMAN
 KANDI MUNICIPALITY

PMAY (HFA - 2019-20)

BENEFICIARY LIST OF KANDI MUNICIPALITY

Sl. No.	Ward No	SLUM /Non Slum	Name of Beneficiary	Father's Name / Husband's Name	Holding No./Address	Category		Gender	Adhaar No.	Mob No.	Photo
						General/S.C./O.B. C./S.T	Minority				
1	3	KURURPARA (046)	TAPAN DAS	SHYAMAPADA DAS	KANDI KURURPARA	SC	NO	M	826874367017	8348257770	
2	3	KURURPARA (046)	DINESH CHANDRA DAS	BHAKTI BHUSAN DAS	KANDI KURURPARA	GENERAL	NO	M	343128438581	8001887950	
3	3	KURURPARA (046)	SAMIR KONAI	GANAPATI KONAI	KANDI KURURPARA	SC	NO	M	320330093591	8001887950	
4	3	KURURPARA (046)	ARUP MUKHERJEE	ASIT MUKHERJEE	KANDI KURURPARA	GENERAL	NO	M	283168596263	9734600933	
5	3	KURURPARA (046)	TARAKNATH DAS	BAIDYANATH DAS	KANDI JIBDHARPARA	GENERAL	NO	M	337002541922	9002598900	

 CHAIRMAN
 KANDI MUNICIPALITY

PMAY (HFA- 2019-20)



BENEFICIARY LIST OF KANDI MUNICIPALITY

Sl. No.	Ward No	SLUM /Non Slum	Name of Beneficiary	Father's Name / Husband's Name	Holding No./Address	Category		Gender	Adhaar No.	Mob No.	Photo
						General/S.C./O.B. C./S.T	Minority				
1	4	SC 006	MLOY BORAL	BINOYENDRA BORAL	19/86, NAMUKANDI	GENERAL	NO	M	29725458418 8	9333213627	
2	4	SC 006	SIRAJUL HAQUE	REAJUL HAQUE	30/D/107, NAMUKANDI	OBC	YES	M	91582870732 0		

CHAIRMAN
KANDI MUNICIPALITY

PMAY (HFA- 2019-20)









BENEFICIARY LIST OF KANDI MUNICIPALITY

Sl. No.	Ward No	SLUM /Non Slum	Name of Beneficiary	Father's Name / Husband's Name	Holding No./Address	Category		Gender	Adhaar No.	Mob No.	Photo
						General/S.C./O.B. C./S.T	Minority				
1	4	SC 0076 GOPINATHPU R KONAIPAR	PURNIMA GUIN	HARADHAN DAS	180/A, GOPINATHPUR KONAIPARA	OBC	NO	F	582267725617	9083461249	
2	4	SC 0018 GOPINATHPU R KONAIPAR	RUDRADEB SARKAR	DURGAPADA SARKAR	82/182/243, GOPINATHPUR KONAIPARA	SC	NO	M	230227173800	9932916242	

CHAIRMAN
KANDI MUNICIPALITY

PMAY (HFA- 2019-20)

BENEFICIARY LIST OF KANDI MUNICIPALITY

Sl. No.	Ward No	SLUM /Non Slum	Name of Beneficiary	Father's Name / Husband's Name	Holding No./Address	Category		Gender	Adhaar No.	Mob No.	Photo
						General/S.C./O.B. C./S.T	Minority				
1	4	SC 047 GHOSH PARA	DAMU GHOSH	LT. NANDA GHOSH	112/C/245, GHOSH PARA	OBC	NO	M	453989396738		
2	4	SC 047 GHOSH PARA	PARIMAL GHOSH	NABAKUMAR GHOSH	2787, GHOSH PARA	OBC	NO	M	4966610236545	993289675	
3	4	SC 047 GHOSH PARA	SUKUMAR PRAMANIK	LOHARAM PRAMANIK	93/D/221, GHOSH PARA	OBC	NO	M	586898140883	9932865330	
4	4	SC 047 GHOSH PARA	SUSANTA GHOSH	CHANDBADAN GHOSH	112/A/242, GHOSH PARA	OBC	NO	M	751365988787	9002177178	
5	4	SC 047 GHOSH PARA	CHAMPA DAS	KRISHNA CHANDRA DAS	24/10, GHOSH PARA	OBC	NO	M	427703143950	8145107654	
6	4	SC 047 GHOSH PARA	TARUN KR. DAS	LT. LAXMIPADA DAS	100/205, GHOSH PARA	OBC	NO	M	285883272331	9932326348	
7	4	SC 047 GHOSH PARA	BILLWAMONGAL KUNDU	BIRENDRA KUMAR KUNDU	104/213 GHOSH PARA	OBC	NO	M	609912071852	8327472683	
8	4	SC 047 GHOSH PARA	PROSENJIT MONDAL	SARAT KUMAR MONDAL	83/190, GHOSH PARA	S.C	NO	M	679271539807	8336843901	



CHAIRMAN
KANDI MUNICIPALITY

BENEFICIARY LIST OF KANDI MUNICIPALITY

Sl. No.	Ward No	SLUM /Non Slum	Name of Beneficiary	Father's Name / Husband's Name	Holding No./Address	Category		Gender	Adhaar No.	Mob No.	Photo
						General/S.C./O.B. C./S.T	Minority				
1	4	SC 007	RABI MONDAL	LT. AMAL MONDAL	DAG-710, MOLLAPARA	SC	NO	M	25559074470 7	9609368656	
2	4	SC 007	RABINDRANATH MAHANTA	ADHIR MAHANTA	DAG-2809, MOLLAPARA	GENERAL	NO	M	67660928227 7	9735679742	
3	4	SC 007	RUDRADEB GHOSH	RAMCHARAN GHOSH	9/9, MOLLAPARA	OBC	NO	M	22353331604 8	9564389750	

CHAIRMAN
KANDI MUNICIPALITY









BENEFICIARY LIST OF KANDI MUNICIPALITY

Sl. No.	Ward No	SLUM /Non Slum	Name of Beneficiary	Father's Name / Husband's Name	Holding No./Address	Category		Gender	Adhaar No.	Mob No.	Photo
						General/S.C./O.B. C./S.T	Minority				
1	5	MOHANBAGA N BAGANPARA 048	ARUN KR. MOJUMDAR	HARIMOY MOJUMDAR	NEW/048, MOHANBAGAN	GENERAL	NO	M	498727171193 8	9474644315	
2	5	MOHANBAGA N BAGANPARA 049	JAMINUR RAHAMAN KHAN	ANISUR RAHAMAN KHAN	NEW/96, MOHANBAGAN	GENERAL	Minority	M	839801029912	8617821043	
3	5	MOHANBAGA N BAGANPARA 050	SABIR SK.	NUR MOHAMMAD SK.	NEW-10, MOHANBAGAN	GENERAL	Minority	M	749646615767	6294730126	
4	5	MOHANBAGA N BAGANPARA 051	SABIBUR RAHAMAN	JAFAR SK.	178/68/B, BAGANPARA	GENERAL	Minority	M	724358605792	7074793019	
5	5	MOHANBAGA N BAGANPARA 052	MITHUN SEIKH	JABBAR SK.	NEW/65	O B C	Minority	M	858175040056	6297978920	
6	5	MOHANBAGA N BAGANPARA 053	JOBEDA BIBI	KURBAN SK.	NEW/100	O B C	Minority	F	551689974469	627980524	
7	5	MOHANBAGA N BAGANPARA 054	NURNEHAR KHATUN (BEWA)	KALU SK.	140/A/15	O B C	Minority	F	659804266551	6251020511	

CHAIRMAN
KANDI MUNICIPALITY

PMAY (HFA- 2019-20)





BENEFICIARY LIST OF KANDI MUNICIPALITY

Sl. No.	Ward No	SLUM /Non Slum	Name of Beneficiary	Father's Name / Husband's Name	Holding No./Address	Category		Gender	Adhaar No.	Mob No.	Photo
						General/S.C./O.B. C./S.T	Minority				
1	5	PURATANHAT (009)	HEMANTA CHOWDHURY	SUNIL CHOWDHURY	25/09, PURATANHAT	GENERAL	NO	M	394209638376	9733957225	
2	5	PURATANHAT (009)	BIPLAB MONDAL	BIRENDRA KR. MONDAL	66/15, PURATANHAT	GENERAL	NO	M	307114573452	9434851557	
3	5	PURATANHAT (009)	PROBIR KR. SAHA	SOURENDRA SAHA	73/51, PURATANHAT	SC	NO	M	308835162107	9064039419	
4	5	PURATANHAT (009)	MOUSUMI DE	PROBIR KR. DE	PURATANHAT	GENERAL	NO	F	804671194501	9563922797	
5	5	PURATANHAT (009)	RAJIBUL RAHAMAN	ANM MUSTAFIZUR RAHAMAN	1/34/1, PURATANHAT	O B C	Minority	M	616681149930	9564132767	
6	5	PURATANHAT (009)	BUDDHADEB DUTTA	SHYAMAL DUTTA	56/49/1	GENERAL	NO	M	773446218767	9635582357	
7	5	PURATANHAT (009)	GOUTAM DAS	RADHAMOHAN DAS	14/K/85	GENERAL	NO	M	207304260531	7872622875	
8	5	PURATANHAT (009)	GOUTAM DAS	BISWANATH DAS	6611/1, PURATANHAT	GENERAL	NO	M	597757625077	9832732766	

 CHAIRMAN
 KANDI MUNICIPALITY

PMAY (HFA- 2019-20)









BENEFICIARY LIST OF KANDI MUNICIPALITY

Sl. No.	Ward No	SLUM /Non Slum	Name of Beneficiary	Father's Name / Husband's Name	Holding No./Address	Category		Gender	Adhaar No.	Mob No.	Photo
						General/S.C./O.B. C./S.T	Minority				
1	5	NON SLUM	BANDANA CHANDRA	SOCHI DULAL CHANDRA	80/K/154/1, DANGAPARA	GENERAL	NO	F	457792388045	8001931548	
2	5	NON SLUM	TILAKA DUTTA	POTITPABAN DUTTA	67/A/171, DANGAPARA	GENERAL	NO	F	654210214420	7001035165	
3	5	NON SLUM	URMILA DAS	SWAPAN DAS	53/69/1, DANGAPARA	GENERAL	NO	F	966065150562	9735236695	
4	5	NON SLUM	TAPAN CHATTARAU	BHABESH CHANDRA CHATTARAU	DANGAPARA	GENERAL	NO	M	355558251424	9476274447	
5	5	NON SLUM	DEBASIS DAS	SUNIL KR. DAS	75/160, DANGAPARA	GENERAL	NO	M	713422708703	9051264374	











 CHAIRMAN
 KANDI MUNICIPALITY

PMAY (HFA- 2019-20)

BENEFICIARY LIST OF KANDI MUNICIPALITY

Sl. No.	Ward No	SLJM /Non Slum	Name of Beneficiary	Father's Name / Husband's Name	Holding No./Address	Category		Gender	Adhaar No.	Mob No.	Photo
						General/S.C./O.B. C./S.T	Minority				
1	6	SC 011 CHHAKUPAR A	PRATIMA DAS	NEMAI DAS	BHOLANATHPUR	S.C.	NO	F	956497608987	7602352523	
2	6	SC 011 CHHAKUPAR A	UTTAM DAS	LT. SHANKAR DAS	BHOLANATHPUR	S.C.	NO	M	399707381937	8101773057	
3	6	SC 011 CHHAKUPAR A	PRABIR DAS	LT. DINESH CHANDRA DAS	BHOLANATHPUR	OBC	NO	M	611116748013	9333321135	
4	6	SC 011 CHHAKUPAR A	KANCHAN DAS	LT. NIBARAN CHANDRA DAS	BHOLANATHPUR	S.C.	NO	M	327944394116	9647447016	
5	6	SC 011 CHHAKUPAR A	PRASHANTA DAS	LT. RASRAJ DAS	BHOLANATHPUR	S.C.	NO	M	745901120737	9382119862	
6	6	SC 011 CHHAKUPAR A	RAKESH KUMAR DAS	PROVASH DAS	BHOLANATHPUR	S.C.	NO	M	525594909774	7031613201	
7	6	SC 011 CHHAKUPAR A	HEMANTA DAS	LT. JOYDEB DAS	BHOLANATHPUR	S.C.	NO	M	625979935381	9832701259	
8	6	SC 011 CHHAKUPAR A	SUNIL DAS	LT. KINKAR DAS	BHOLANATHPUR	S.C.	NO	M	854293490991	7477587690	

CHAIRMAN
KANDI MUNICIPALITY

Sl. No.	Ward No	SLUM /Non Slum	Name of Beneficiary	Father's Name / Husband's Name	Holding No./Address	Category		Gender	Adhaar No.	Mob No.	Photo
						General/S. C./O.B. C./S. T	Minority				
9	6	SC 011 CHHAKUPAR A	JOYDEB DAS	LT. NARAYAN CHANDRA DAS	BHOLANATHPUR	GENERAL	NO	M	412764709735	7797318704	
10	6	SC 011 CHHAKUPAR A	AMAL DAS	LT. SUDHIR DAS	BHOLANATHPUR	OBC	NO	M	984201382951	9733546050	
11	6	SC 011 CHHAKUPAR A	CHANDU DAS	LT. SHIRIS DAS	BHOLANATHPUR	S.C.	NO	M	461058680329	7363014252	
12	6	SC 011 CHHAKUPAR A	RAJU DAS	LT. TENU DAS	BHOLANATHPUR	S.C.	NO	M	999774842417	8348838537	
13	6	SC 011 CHHAKUPAR A	TAPAS DAS	DHANU DAS	BHOLANATHPUR	S.C.	NO	M	567046132898	9933373513	
14	6	SC 011 CHHAKUPAR A	SANJIT DAS	DHANANJOY DAS	BHOLANATHPUR	S.C.	NO	M	885346327903	9083675716	
15	6	SC 011 CHHAKUPAR A	SUBHAS DAS	LT. NISHAN DAS	BHOLANATHPUR	S.C.	NO	M	973327631267	9734451591	
16	6	SC 011 CHHAKUPAR A	IMANIK DAS	SHIRISH DAS	SC 011 CHHAKUPARA	S.C.	NO	M	956665524427	8913452544	
17	6	SC 011 CHHAKUPAR A	ALOK KUMAR PRAMANIK	AJIT KUMAR PRAMANIK	SC 011 CHHAKUPARA	GENERAL	NO	M	366681752202	9932913578	





CHAIRMAN
KANDI MUNICIPALITY

Sl. No.	Ward No	SLUM /Non Slum	Name of Beneficiary	Father's Name / Husband's Name	Holding No./Address	Category		Gender	Adhaar No.	Mob No.	Photo
						General/S.C./O.B. C./S.T	Minority				
18	6	SC 011 CHHAKUPAR A	PRASANTA DAS	LT. KARTICJ DAS	SC 011 CHHAKUPARA	S.C.	NO	M	911043720354	8371017612	











CHAIRMAN
KANDI MUNICIPALITY

PMAY (HFA- 2019-20)









BENEFICIARY LIST OF KANDI MUNICIPALITY

Sl. No.	Ward No	SLUM /Non Slum	Name of Beneficiary	Father's Name / Husband's Name	Holding No./Address	Category		Gender	Adhaar No.	Mob No.	Photo
						General/S.C./O.B.C./S.T	Minority				
1	6	SC 010 RAJADIGHIRP AR	REBATI BARIK	KHANDU BARIK	RAJADIGHIRPAR	S.C.	NO		460387858734	9641770477	
2	6	SC 010 RAJADIGHIRP AR	SHANTWANA HAZRA	BABAN HAZRA	RAJADIGHIRPAR	S.C.	NO	F	981509295958	7864899405	
3	6	SC 010 RAJADIGHIRP AR	SOHAGI BAGDI	LOHARAM BAGDI	RAJADIGHIRPAR	S.C.	NO	F	252701673159	7479099048	
4	6	SC 010 RAJADIGHIRP AR	ANANDA DULAL PAL	SAMAR KUMAR PAL	RAJADIGHIRPAR	O.B.C	NO	F	814201813273	9064855612	
5	6	SC 010 RAJADIGHIRP AR	GONESH HAZRA	DUSHAWAR HAZRA	RAJADIGHIRPAR	S.C.	NO	M	902117900710	6296886092	
6	6	SC 010 RAJADIGHIRP AR	CHINTAMANI GHOSH	DABOBRATO GHOSH	RAJADIGHIRPAR	GENERAL	NO	F	236958324780	9051445321	
7	6	SC 010 RAJADIGHIRP AR	PARIMAL PAL	SUNIL PAL	RAJADIGHIRPAR	O.B.C	NO	M	458345240661	7076422934	
8	6	SC 010 RAJADIGHIRP AR	SANJIB PAL	LT. SUKHEN PAL	RAJADIGHIRPAR	O.B.C	NO	M	401903737263	7918862249	
9	6	SC 010 RAJADIGHIRP AR	SHRIKANTO HAZRA	ANANDA HAZRA	RAJADIGHIRPAR	S.C.	NO	M	938715545057	9679249122	

CHAIRMAN
KANDI MUNICIPALITY

Sl. No.	Ward No	SLUM /Non Slum	Name of Beneficiary	Father's Name / Husband's Name	Holding No./Address	Category		Gender	Adhaar No.	Mob No.	Photo
						General/S.C./O.B.C./S.T	Minority				
10	6	SC 010 RAJADIGHIRPAR	MANIKA PAL	UJJAL PAL	RAJADIGHIRPAR	O.B.C	NO	F	930481202236	9734870528	
11	6	SC 010 RAJADIGHIRPAR	SUKHEN PAL	LT. KAMALA KANTA PAL	RAJADIGHIRPAR	O.B.C	NO	M	424367746966	9775185594	
12	6	SC 010 RAJADIGHIRPAR	MAHADEV PAL	LT. SHIV SHANKAR PAL	RAJADIGHIRPAR	O.B.C	NO	M	932028166626	8900227410	
13	6	SC 010 RAJADIGHIRPAR	SANJOY NANDI	BISWANATH NANDI	RAJADIGHIRPAR	GENERAL	NO	M	969905032325	9732767185	
14	6	SC 010 RAJADIGHIRPAR	SUDHAKAR KONAI	LT. RAMKRISHNA KONAI	RAJADIGHIRPAR	S.C.	NO	M	216518299419	9775677941	
15	6	SC 010 RAJADIGHIRPAR	JYOTIRMOY PAL	BHOLANATH PAL	RAJADIGHIRPAR	O.B.C	NO	M	266138608460	7501291580	
16	6	SC 010 RAJADIGHIRPAR	PRASANTA SAHA	LT. ROYKAMAL SAHA	RAJADIGHIRPAR	S.C.	NO	M	933055597577	9474486030	
17	6	SC 010 RAJADIGHIRPAR	SWAPAN SAHA	LT. NIL KAMAL SAHA	RAJADIGHIRPAR	S.C.	NO	M	357221932655	6296681995	
18	6	SC 010 RAJADIGHIRPAR	RAKSHAKAR SAHA	LT. SHANTIRAM SAHA	RAJADIGHIRPAR	S.C.	NO	M	909400955089	6297558612	
19	6	SC 010 RAJADIGHIRPAR	MAKHAN SAHA	BISWANATH SAHA	RAJADIGHIRPAR	S.C.	NO	M	268095290982	9733763306	









CHAIRMAN
KANDI MUNICIPALITY

Sl. No.	Ward No	SLUM /Non Slum	Name of Beneficiary	Father's Name / Husband's Name	Holding No./Address	Category		Gender	Adhaar No.	Mob No.	Photo
						General/S.C./O.B. C./S.T	Minority				
20	6	SC 010 RAJADIGHIRP AR	CHAND GOPAL SAHA	LT. SANAT SAHA	RAJADIGHIRPAR	S.C.	NO	M	551379601115	9932842258	
21	6	SC 010 RAJADIGHIRP AR	SOMNATH SAHA	SITAL SAHA	RAJADIGHIRPAR	S.C.	NO	M	784264035507	9734305412	
22	6	SC 010 RAJADIGHIRP AR	HARERAM KONAI	LT. NIBHARESH KONAI	RAJADIGHIRPAR	S.C.	NO	M	845564891691	7908431379	
23	6	SC 010 RAJADIGHIRP AR	AJAY DAS	JAGANNATH DAS	RAJADIGHIRPAR	S.C.	NO	M	686331511329	9734917979	
24	6	SC 010 RAJADIGHIRP AR	RABI HAZRA	LALCHAND HAZRA	RAJADIGHIRPAR	S.C.	NO	M	314854657539	6294345057	
25	6	SC 010 RAJADIGHIRP AR	HRIDAY GHOSH	MILAN GHOSH	RAJADIGHIRPAR	GENERAL	NO	M	293738565333	9734578524	
26	6	SC 010 RAJADIGHIRP AR	SHIKHA HAZRA	MATAR HAZRA	RAJADIGHIRPAR	S.C.	NO	M	415606305830	8372872605	
27	6	SC 010 RAJADIGHIRP AR	SANKU PAL	MANGAL PAL	RAJADIGHIRPAR	O.B.C	NO	M	249242190076	9547237932	











CHAIRMAN
KANDI MUNICIPALITY

PMAY (HFA- 2019-20)









BENEFICIARY LIST OF KANDI MUNICIPALITY

Sl. No.	Ward No	SLUM /Non Slum	Name of Beneficiary	Father's Name / Husband's Name	Holding No./Address	Category		Gender	Adhaar No.	Mob No.	Photo
						General/S.C./O.B.C./S.T	Minority				
1	6	SC 012 ADIRAPARA	INDRADEB MONDAL	ANANDA MONDAL	CHHATINAKANDI ARIDAPARA	GENERAL	NO	M	685090493956	9733743740	
2	6	SC 012 ADIRAPARA	RAJIB MONDAL	RATAN MONDAL	CHHATINAKANDI ARIDAPARA	GENERAL	NO	M	325695903045	8016044161	
3	6	SC 012 ADIRAPARA	DIBAKAR MONDAL	LT. SHANTI RAMI MONDAL	CHHATINAKANDI ARIDAPARA	GENERAL	NO	M	757391214426	7797229677	
4	6	SC 012 ADIRAPARA	HARICHARAN DAS	LT. PARAMANANDA DAS	CHHATINAKANDI ARIDAPARA	GENERAL	NO	M	489333521989	9382867627	
5	6	SC 012 ADIRAPARA	ACHINTA MONDAL	TAMAL MONDAL	CHHATINAKANDI ARIDAPARA	GENERAL	NO	M	755636800290	7557069311	
6	6	SC 012 ADIRAPARA	LAKSHMI MONDAL	LT. SHANKAR MONDAL	CHHATINAKANDI ARIDAPARA	GENERAL	NO	F	779532457756	8370814721	
7	6	SC 012 ADIRAPARA	BABLU MONDAL	JAGANNATH MONDAL	CHHATINAKANDI ARIDAPARA	GENERAL	NO	M	919476266529	8145337814	
8	6	SC 012 ADIRAPARA	CHIRANJIT GHOSH	LT. MURARI MOHAN GHOSH	CHHATINAKANDI ARIDAPARA	GENERAL	NO	M	881772477856	8768101201	











 CHAIRMAN
 KANDI MUNICIPALITY

Sl. No.	Ward No	SLUM / Non Slum	Name of Beneficiary	Father's Name / Husband's Name	Holding No./Address	Category		Gender	Adhaar No.	Mob No.	Photo
						General/S.C./O.B.C./S.T	Minority				
9	6	SC 012 ADIRAPARA	MANIK CHAKRABORTY	LT. BISHNUPADA CHAKRABORTY	CHHATINAKANDI ARIDAPARA	GENERAL	NO	M	240591398139	9593831978	
10	6	SC 012 ADIRAPARA	DILIP MONDAL	LT. ARJUN MONDAL	CHHATINAKANDI ARIDAPARA	GENERAL	NO	M	930680564909	8001366194	
11	6	SC 012 ADIRAPARA	MINAKSHI MONDAL	SUBHAS MONDAL	CHHATINAKANDI ARIDAPARA	GENERAL	NO	F	777451640557	8617459584	
12	6	SC 012 ADIRAPARA	CHANDANA SARKAR	SUJIT SARKAR	CHHATINAKANDI ARIDAPARA	GENERAL	NO	F	499621760250	9088423543	
13	6	SC 012 ADIRAPARA	DEBASIS SIDDHANTA	LT. TAPAS SIDDHANTA	CHHATINAKANDI ARIDAPARA	GENERAL	NO	M	717015741622	7501602372	
14	6	SC 012 ADIRAPARA	SANJU BANERJEE	SUBODH BANERJEE	CHHATINAKANDI NEW - 291/1	GENERAL	NO	M	223940956939	9733796922	
15	6	SC 012 ADIRAPARA	BUDDHADEV PAL	SASTHIDEV PAL	CHHATINAKANDI ARIDAPARA	GENERAL	NO	M	230919197174	9547155142	
16	6	SC 012 ADIRAPARA	CHANDANA DEY	LT. BISWANATH DEY	CHHATINAKANDI 265-359	GENERAL	NO	F	846456433385	8170022266	
17	6	SC 012 ADIRAPARA	APURBA BANERJEE	LT. SHAKTIPADA BANERJEE	CHHATINAKANDI ARIDAPARA	GENERAL	NO	M	767169681027	8116606824	





CHAIRMAN
KANDI MUNICIPALITY

Sl. No.	Ward No	SLUM / Non Slum	Name of Beneficiary	Father's Name / Husband's Name	Holding No./Address	Category		Gender	Adhaar No.	Mob No.	Photo
						General/S.C./O.B.C./S.T	Minority				
18	6	SC 012 ADIRAPARA	ARUP MONDAL	UTTAM MONDAL	CHHATINAKANDI KANAISINGH PAR	GENERAL	NO	M	810944611125	9609025775	
19	6	SC 012 ADIRAPARA	JAGAT PAL	LT. AJIT PAL	CHHATINAKANDI ARIDAPARA	GENERAL	NO	M	978919558543	6294611550	
20	6	SC 012 ADIRAPARA	SANJU GHOSH	BIPAD TARAN GHOSH	CHHATINAKANDI ARIDAPARA	GENERAL	NO	M	689958753473	8925891506	
21	6	SC 012 ADIRAPARA	SOUJEN CHAKRABORTY	LT. RANESH CHAKRABORTY	CHHATINAKANDI ARIDAPARA	GENERAL	NO	M	816350215794	9734849634	
22	6	SC 012 ADIRAPARA	OLI PAL	ASIT PAL	CHHATINAKANDI ARIDAPARA	GENERAL	NO	F	430630511180	9609114478	
23	6	SC 012 ADIRAPARA	UJJAL DAS	TARUN DAS	CHHATINAKANDI ARIDAPARA	GENERAL	NO	M	307910341267	9083583780	
24	6	SC 012 ADIRAPARA	TANMOY MONDAL	LT. BRINDABAN MONDAL	CHHATINAKANDI ARIDAPARA	GENERAL	NO	M	374835445962	9732353988	
25	6	SC 012 ADIRAPARA	DEBABRATA MONDAL	DHANANJOY MONDAL	CHHATINAKANDI ARIDAPARA	GENERAL	NO	M	632962734187	7797316157	
26	6	SC 012 ADIRAPARA	BIKASH MONDAL	MEGHNATH MONDAL	CHHATINAKANDI BANGALPARA	GENERAL	NO	M	622140868443	9734669039	

CHAIRMAN
KANDI MUNICIPALITY

Sl. No.	Ward No	SLUM /Non Slum	Name of Beneficiary	Father's Name / Husband's Name	Holding No./Address	Category		Gender	Adhaar No.	Mob No.	Photo
						General/S.C./O.B .C./S.T	Minority				
27	6	SC 012 ADIRAPARA	RANJIT KUMAR SAHA	RAMNANDAN SAHA	CHHATINAKANDI BANGALPARA	GENERAL	NO	M	778763731876	9832873376	
28	6	SC 012 ADIRAPARA	MONORANJAN SIDDHANTA	AMBIKA RANJAN SIDDHANTA	CHHATINAKANDI BANGALPARA	GENERAL	NO	M	422027322635	7076713623	
29	6	SC 012 ADIRAPARA	LILA GHOSH	SAKSHI GOPAL GHOSH	CHHATINAKANDI BANGALPARA	GENERAL	NO	F	744761617539	7865808584	
30	6	SC 012 ADIRAPARA	PALASH GHOSH	LT. LAXMAN GHOSH	CHHATINAKANDI BANGALPARA	GENERAL	NO	M	244185836764	8016433047	
31	6	SC 012 ADIRAPARA	PARTHA SIDDHANTA	LT. GOURANGA SIDDHANTA	CHHATINAKANDI	GENERAL	NO	M	402075058916	9382401914	
32	6	SC 012 ADIRAPARA	BARUN MONDAL	LT. MAHADEB MONDAL	CHHATINAKANDI	GENERAL	NO	M	342008082352	9735733480	
33	6	SC 012 ADIRAPARA	TARUN KUMAR MONDAL	LT. THAKHARI MONDAL	CHHATINAKANDI	GENERAL	NO	M	340536554513	9933748770	
34	6	SC 012 ADIRAPARA	BABUSONA MONDAL	KALACHAND MONDAL	CHHATINAKANDI	GENERAL	NO	M	366928066114	9609080209	
35	6	SC 012 ADIRAPARA	PRIYANKA BIRBANSHI	MIRINAL BIRBANSHI	CHHATINAKANDI	S.C.	NO	F	503989807138	9614451081	

 CHAIRMAN
 KANDI MUNICIPALITY





Sl. No.	Ward No.	SLUM / Non Slum	Name of Beneficiary	Father's Name / Husband's Name	Holding No./Address	Category		Gender	Adhaar No.	Mob No.	Photo
						General/S.C./O.B.C./S.T	Minority				
36	6	SC 012 ADIRAPARA	MIRA PAL	LT. ANIL KANTA PAL	CHHATINAKANDI	GENERAL	NO	F	936784924342	9932997324	
37	6	SC 012 ADIRAPARA	PARTHO PROTIM GHOSH	NITAI PADA GHOSH	CHHATINAKANDI	GENERAL	NO	M	761868734602	9800109249	
38	6	SC 012 ADIRAPARA	SANATAN MONDAL	BAIDYANATH MONDAL	CHHATINAKANDI	GENERAL	NO	M	975738465197	9679472892	
39	6	SC 012 ADIRAPARA	SHRABONI GHOSH	LT. BHARAT GHOSH	CHHATINAKANDI	GENERAL	NO	F	820426677879	7407727905	



CHAIRMAN
KANDI MUNICIPALITY

PMAY (HFA- 2019-20)









BENEFICIARY LIST OF KANDI MUNICIPALITY

Sl. No.	Ward No	SLUM /Non Slum	Name of Beneficiary	Father's Name / Husband's Name	Holding No./Address	Category		Gender	Adhaar No.	Mob No.	Photo
						General/S.C./O.B. C./S.T	Minority				
1	6	NON SLUM	SHRIKANTA DAS	NAKUL DAS	CHHATINAKANDI	S.C.	NO	M	404220432841	8509177695	
2	6	NON SLUM	HIREN KUMAR DAS	LT. AJIT KUMAR DAS	CHHATINAKANDI	S.C.	NO	M	930075525456	9434637702	
3	6	NON SLUM	JADUPATI DAS	LT. AJIT KUMAR DAS	CHHATINAKANDI	S.C.	NO	M	453876523674	9735385700	
4	6	NON SLUM	RAM CHANDRA BIRBANSHI	SUKHURAM BIRBANSHI	CHHATINAKANDI	S.C.	NO	M	444351873343	9614605649	
5	6	NON SLUM	BARUN BISWAS	LT. DOLGOBINDA BISWAS	CHHATINAKANDI	OBC	NO	M	324300670371	8016915378	





 CHAIRMAN
 KANDI MUNICIPALITY

PMAY (HFA- 2019-20)

BENEFICIARY LIST OF KANDI MUNICIPALITY

Sl. No.	Ward No	SLUM /Non Slum	Name of Beneficiary	Father's Name / Husband's Name	Holding No./Address	Category		Gender	Adhaar No.	Mob No.	Photo
						General/S.C./O.B.C./S.T.	Minority				
1	6	SC 013 TALARPAP	UTPAL MUKHERJEE	SUDHIR MUKHERJEE	CHHATINAKANDI	GENERAL	NO	M	692480769781	9474927271	
2	6	SC 013 TALARPAP	NIKHIL HALDAR	NRISINGHA HALDAR	CHHATINAKANDI	GENERAL	NO	M	279864530968	6286558365	
3	6	SC 013 TALARPAP	SUKANTA DE	LT. BIJAY KUMAR DE	TALARPAP	GENERAL	NO	M	857198284859	9732937062	
4	6	SC 013 TALARPAP	MAYA DAS	SHIB SANKAR DAS	TALARPAP	GENERAL	NO	F	9797997455527	8348669730	
5	6	SC 013 TALARPAP	MADHABI SARKAR	LT. BISWAJIT SARKAR	TALARPAP	GENERAL	NO	F	795660574435	9775094901	
6	6	SC 013 TALARPAP	JANARDHAN CHAKRABORTY	LT. PRABHAKAR CHAKRABORTY	TALARPAP	GENERAL	NO	M	990043144695	6296095812	
7	6	SC 013 TALARPAP	PARTHA SARATHI SAHA	ANANTA KUMAR SAHA	TALARPAP	SC	NO	M	983819305200		
8	6	SC 013 TALARPAP	SUBRATA CHAKRABORTY	BISWANATH CHAKRABORTY	TALARPAP	GENERAL	NO	M	697821305176	9547195537	
9	6	SC 013 TALARPAP	LALAN DAS	LT. ANANDA DAS	TALARPAP	GENERAL	NO	M	820228737818	6294556823	











CHAIRMAN
KANDI MUNICIPALITY

Sl. No.	Ward No	SLUM /Non Slum	Name of Beneficiary	Father's Name / Husband's Name	Holding No./Address	Category		Gender	Adhaar No.	Mob No.	Photo
						General/S.C./O.B.C./S.T	Minority				
10	6	SC 013 TALARPAP	SUDIP MONDAL	SANJOY MONDAL	TALARPAP	GENERAL	NO	M	700677111992	8250013829	
11	6	SC 013 TALARPAP	UTPAL CHAKRABORTY	SARADINDU CHAKRABORTY	TALARPAP	GENERAL	NO	M	325381449802	8348402727	
12	6	SC 013 TALARPAP	ACHINTYA CHAKRABORTY	LT. THAKO HARI CHAKRABORTY	TALARPAP	GENERAL	NO		494490482070	9775361869	











CHAIRMAN
KANDI MUNICIPALITY

PMAY (HFA- 2019- 20)

BENEFICIARY LIST OF KANDI MUNICIPALITY

Sl. No.	Ward No	SLUM /Non Slum	Name of Beneficiary	Father's Name / Husband's Name	Holding No./Address	Category		Gender	Adhaar No.	Mob No.	Photo
						General/S.C./O.B. C./S.T	Minority				
1	7	(SC 14) RASORAH BAGDIPARA	NUPUR BAGDI	LT. ATUL BAGDI	NEW , RASORAH BAGDIPARA	SC	NO	M	978223970675	8967901846	
2	7	(SC 14) RASORAH BAGDIPARA	RAKHAHARI BAGDI	LT. TARAPADA BAGDI	21/197/209, RASORAH	SC	NO	M	910511859038	9635946226	
3	7	(SC 14) RASORAH BAGDIPARA	PUTPUTI BAGDI	MONGAL BAGDI	NEW , RASORAH BAGDIPARA	SC	NO	F	678432757643	9933193913	
4	7	(SC 14) RASORAH BAGDIPARA	SRIMANTA HAZRA	JIBAN HAZRA	NEW , RASORAH BAGDIPARA	SC	NO	M	767973050095	9564630820	
5	7	(SC 14) RASORAH BAGDIPARA	SABITRI BAGDI	LT. SHYAMBABU BAGDI	31/10/12, RASORAH	SC	NO	M	939972204704	9933193913	
6	7	(SC 14) RASORAH BAGDIPARA	NIRMAL BAGDI	SAGAR BGADI	NEW , RASORAH BAGDIPARA	SC	NO	M	807842602933	8537933652	
7	7	(SC 14) RASORAH BAGDIPARA	PRASHANTA BAGDI	ABHAY BAGDI	180/ RASORAH	SC	NO	M	650737744816	8972015142	
8	7	(SC 14) RASORAH BAGDIPARA	RITA BAGDI	AMIT BAGDI	33/10, RASORAH	SC	NO	F	573582027032	9800158419	
9	7	(SC 14) RASORAH BAGDIPARA	RABIN BAGDI	RADHASHYAM BAGDI	33/12/ RASORA	SC	NO	M	735159979672	6297025066	

CHAIRMAN
KANDI MUNICIPALITY

Sl. No.	Ward No	SLUM /Non Slum	Name of Beneficiary	Father's Name / Husband's Name	Holding No./Address	Category		Gender	Adhaar No.	Mob No.	Photo
						General/S.C./O.B. C./S.T	Minority				
10	7	(SC 14) RASORAH BAGDIPARA	PANCHKARI BAGDI	LT. SUDHIR BAGDI	NEW, RASORAH BAGDIPARA	SC	NO	M	546519101588	8116455773	
11	7	(SC 14) RASORAH BAGDIPARA	MITHU BAGDI	SUBIR BAGDI	15/205/217, RASORAH	SC	NO	M	470664578649	8436968856	
12	7	(SC 14) RASORAH BAGDIPARA	SITAL BAGDI	LT. SUDHIR BAGDI	19/199, RASORAH	SC	NO	M	340987939282		
13	7	(SC 14) RASORAH BAGDIPARA	NANIGOPAL HAZRA	LT. ANANDA HAZRA	17/201/NEW, RASORAH	SC	NO	M	925534950167	9609401410	
14	7	(SC 14) RASORAH BAGDIPARA	KATUSONA BAGDI	LT. PROLLAD BAGDI	178/NEW, RASORAH	SC	NO	M	224147964079	8967307672	
15	7	(SC 14) RASORAH BAGDIPARA	SUBHASH BAGDI	LT. SANATAN BAGDI	171, RASORA	SC	NO	M	242200738839	9609207716	
16	7	(SC 14) RASORAH BAGDIPARA	MANIK BAGDI	SUDARSHAN BAGDI	176/2, RASORAH	SC	NO	M	994026408176	6779901549	
17	7	(SC 14) RASORAH BAGDIPARA	PRABHAKAR BAGDI	LT. KALU BAGDI	29/198, RASORAH	SC	NO	M	876506886890	8116772845	
18	7	(SC 14) RASORAH BAGDIPARA	RAJKUMAR BAGDI	NITAI BAGDI	NEW, RASORAH	SC	NO	M	284531551128	8116455709	
19	7	(SC 14) RASORAH BAGDIPARA	MITHUN BAGDI	DEBU BAGDI	37/15, RASORAH	SC	NO	M	724626372847	8016241702	







CHAIRMAN
KANDI MUNICIPALITY

Sl. No.	Ward No	SLUM /Non Slum	Name of Beneficiary	Father's Name / Husband's Name	Holding No./Address	Category		Gender	Adhaar No.	Mob No.	Photo
						General/S.C./O.B. C./S.T	Minority				
20	7	(SC 14) RASORAH BAGDIPARA	ANSHUNATH MONDAL	AJIT KUMAR MONDAL	NEW, RASORAH	GENERAL	NO	M	710039387156	9318325905	

 CHAIRMAN
 KANDI MUNICIPALITY

PMAY (HFA- 2019-20)

BENEFICIARY LIST OF KANDI MUNICIPALITY

Sl. No.	Ward No	SLUM /Non Slum	Name of Beneficiary	Father's Name / Husband's Name	Holding No./Address	Category		Gender	Adhaar No.	Mob No.	Photo
						General/S.C./O.B. C./S.T	Minority				
1	7	(SC 15) GHOSHPARA (WEST)	SUJAN GHOSH	BIBEK GHOSH	96/A/78, RASORAH	GENERAL	NO	M	435136867070	7319276311	
2	7	(SC 15) GHOSHPARA (WEST)	DAYMAY GHOSH	LT. BHIMAPADA GHOSH	NEW, RASORAH	GENERAL	NO	M	900358403535	9903651470	
3	7	(SC 15) GHOSHPARA (WEST)	HIRALAL GHOSH	MILAN GHOSH	68/80, RASORAH	GENERAL	NO	M	989965970970	7551015665	
4	7	(SC 15) GHOSHPARA (WEST)	ASIM GHOSH	LT. LAKSHMAN GHOSH	30, RASORAH	GENERAL	NO	M	773999715120	8016619330	
5	7	(SC 15) GHOSHPARA (WEST)	SUGRIB GHOSH	SHASTIPADA GHOSH	131/A/150, RASORAH	GENERAL	NO	M	973873126131	9679961070	
6	7	(SC 15) GHOSHPARA (WEST)	KAJAL KUMAR GHOSH	LT. ATUL PRASAD GHOSH	34/37, RASORAH	GENERAL	NO	M	725394501783	9932999655	
7	7	(SC 15) GHOSHPARA (WEST)	SUBHADRA GHOSH	BARUN GHOSH	NEW, RASORAH	GENERAL	NO	F	464130163453	7584997799	
8	7	(SC 15) GHOSHPARA (WEST)	BIMAL GHOSH	LT. BINAY GHOSH	NEW, RASORAH	GENERAL	NO	M	360695084908	7001088030	
9	7	(SC 15) GHOSHPARA (WEST)	BIMAL GHOSH	LT. NITYA RANJAN GHOSH	NEW, RASORAH	GENERAL	NO	M	782155054051	8116206362	

CHAIRMAN
KANDI MUNICIPALITY









Sl. No.	Ward No	SLUM /Non Slum	Name of Beneficiary	Father's Name / Husband's Name	Holding No./Address	Category		Gender	Adhaar No.	Mob No.	Photo
						General/S.C./O.B. C./S.T	Minority				
10	7	(SC 15) GHOSHPARA (WEST)	AKKARI GHOSH	KADAI GHOSH	NEW, RASORAH	GENERAL	NO	M	506133685455	7872388062	
11	7	(SC 15) GHOSHPARA (WEST)	SANJOY GHOSH	TAPAS GHOSH	NEW, RASORAH	GENERAL	NO	M	453048584145	9083928614	
12	7	(SC 15) GHOSHPARA (WEST)	RAJESH GHOSH	SUNIL KUMAR GHOSH	187, RASORAH	GENERAL	NO	M	446719108940	9126519022	
13	7	(SC 15) GHOSHPARA (WEST)	ARUN GHOSH	RAM CHANDRA GHOSH	100/NEW, RASORAH	GENERAL	NO	M	674720825819	9679247481	
14	7	(SC 15) GHOSHPARA (WEST)	TARAKNATH GHOSH	SUDEB GHOSH	48/31, RASORAH	GENERAL	NO	M	458415331568	9800158419	
15	7	(SC 15) GHOSHPARA (WEST)	SUNDARBAN GHOSH	LT. SHANKAR GHOSH	NEW, RASORAH	GENERAL	NO	M	430085711103	9476489049	



CHAIRMAN
KANDI MUNICIPALITY









PMAY (HFA- 2019-20)











BENEFICIARY LIST OF KANDI MUNICIPALITY

Sl. No.	Ward No	SLUM /Non Slum	Name of Beneficiary	Father's Name / Husband's Name	Holding No./Address	Category		Gender	Adhaar No.	Mob No.	Photo
						General/S.C./O.B. C./S.T	Minority				
1	7	(SC 16) RASORAH PASCHIMPAR A	FURA DALUI	LT. ORMA DALUI	40/A/151-161, RASORAH	SC	NO.	M	241516016053	6290563148	
2	7	(SC 16) RASORAH PASCHIMPAR A	LATA DALUI	LT. RABI DALUI	35/159, RASORAH	SC	NO.	M	802427558070	9593026494	
3	7	(SC 16) RASORAH PASCHIMPAR A	UTPAL DALUI	RUDRAKANTA DALUI	38/154, RASORAH	SC	NO.	M	383091173871	8001894578	
4	7	(SC 16) RASORAH PASCHIMPAR A	MIHIR DALUI	MANMATA DALUI	190/205, RASORAH	SC	NO.	M	998288285713	9547128890	
5	7	(SC 16) RASORAH PASCHIMPAR A	SAHADEB DALUI	LT. KARTIK DALUI	NEW, RASORAH	SC	NO.	M	504033648176	7865945067	
6	7	(SC 16) RASORAH PASCHIMPAR A	BISWAJIT DALUI	RABI DALUI	5/206, RASORAH	SC	NO.	M	213752233145	8322348680	
7	7	(SC 16) RASORAH PASCHIMPAR A	SUFAL SAHA	BIPADARAN SAHA	11/217-233, RASORAH	SC	NO.	M	601416745197	9002274734	
8	7	(SC 16) RASORAH PASCHIMPAR A	HARIDAS DALUI	LT. ANIL DALUI	168, RASORAH	SC	NO.	F	328013260948		
9	7	(SC 16) RASORAH PASCHIMPAR A	ANIMESH SAHA	LT. JASHODA NANDAN SAHA	NEW, RASORAH	GENERAL	NO.	M	428245759649	8001294411	



CHAIRMAN
KANDI MUNICIPALITY

Sl. No.	Ward No	SLUM /Non Slum	Name of Beneficiary	Father's Name / Husband's Name	Holding No./Address	Category		Gender	Adhaar No.	Mob No.	Photo
						General/S.C./O.B. C./S.T	Minority				
10	7	(SC 16) RASORAH PASCHIMPAR A	TAPAN MANDAL	LT. NITYA GOPAL MANDAL	54/11/1, RASORAH	GENERAL	NO.	M	241207623396	9475900088	
11	7	(SC 16) RASORAH PASCHIMPAR A	ARIJUN DALUI	JOYDEB DALUI	222/238, RASORAH	SC	NO.	M	562526224409	9564859803	
12	7	(SC 16) RASORAH PASCHIMPAR A	RUMKI DALUI	BASUDEB DALUI	11/A, RASORAH	SC	NO.	F	309917920246	6294725795	
13	7	(SC 16) RASORAH PASCHIMPAR A	SHYAMAL DALUI	BISWANATH DALUI	200, RASORAH	SC	NO.	M	559762577183	9093290964	
14	7	(SC 16) RASORAH PASCHIMPAR A	SUMITRA GHOSH	LT. SAMIR GHOSH	NEW-9, RASORAH	GENERAL	NO.	F	956061630238	7797508640	
15	7	(SC 16) RASORAH PASCHIMPAR A	BHAGIRATH MONDAL	LT. DILIP MONDAL	130/B/7, RASORAH	GENERAL	NO.	M	214300100083	9933509301	
16	7	(SC 16) RASORAH PASCHIMPAR A	TILAKA DALUI	LT. SURYA NARAYAN DALUI	215, RASORAH	SC	NO.	F	337618078324	8016549465	
17	7	(SC 16) RASORAH PASCHIMPAR A	MANTU DALUI	LT. RAMESWAR DALUI	18/B/188-203, RASORAH	SC	NO.	M	530396135096	7872913837	
18	7	(SC 16) RASORAH PASCHIMPAR A	KHAKAN DALUI	LT. DHIRU DALUI	NEW-199, RASORAH	SC	NO.	M	869224501542	8927174215	
19	7	(SC 16) RASORAH PASCHIMPAR A	BABURAM DALUI	LT. SUDHIR DALUI	NEW, RASORAH	SC	NO.	M	517084568330	9775565582	

Sl. No.	Ward No	SLUM /Non Slum	Name of Beneficiary	Father's Name / Husband's Name	Holding No./Address	Category		Gender	Adhaar No.	Mob No.	Photo
						General/S.C./O.B. C./S.T	Minority				
20	7	(SC 16) RASORAH PASCHIMPAR A	DEBEN DALUI	DALIM DALUI	18/B/188, RASORAH	SC	NO.	M	506253428230	9749257718	
21	7	(SC 16) RASORAH PASCHIMPAR A	RUDRADEB MANDAL	BAIDYANATH MANDAL	106/A/12/131, RASORAH	GENERAL	NO.	M	407715825103	7872438520	
22	7	(SC 16) RASORAH PASCHIMPAR A	SHILA DAS	LT. RAGHU DAYAL DAS	61/23, RASORAH	GENERAL	NO.	F	515668791071	7407950161	
23	7	(SC 16) RASORAH PASCHIMPAR A	UTTAM MANDAL	GOPESHWAR MANDAL	NEW, RASORAH	GENERAL	NO.	M	330752921538	9134284783	
24	7	(SC 16) RASORAH PASCHIMPAR A	JAYANTA DAS	LT. DEBENDRA NATH DAS	62/B/30, RASORAH	GENERAL	NO.	M	449643871714	7872913550	
25	7	(SC 16) RASORAH PASCHIMPAR A	GOUTAM MANDAL	GOPESHWAR MANDAL	141/151, RASORAH	GENERAL	NO.	M	707663007685	7407111293	
26	7	(SC 16) RASORAH PASCHIMPAR A	TARUN KUMAR GHOSH	AMARESH GHOSH	105/115, RASORAH	GENERAL	NO.	M	206121670240	6295681196	
27	7	(SC 16) RASORAH PASCHIMPAR A	ASISH DAS	LT. SATYA NARAYAN DAS	NEW, RASORAH	GENERAL	NO.	M	503040272659	9153002442	
28	7	(SC 16) RASORAH PASCHIMPAR A	MANDAL DAS	LT. RAGHU NATH DAS	135, RASORAH	GENERAL	NO.	M	568385425570	9641926298	
29	7	(SC 16) RASORAH PASCHIMPAR A	DEBASIS SARKAR	SAMPAD SARKAR	202/202, RASORAH	GENERAL	NO.	M	353351147458	9732114107	

CHAIRMAN
KANDI MUNICIPALITY



Sl. No.	Ward No	SLUM /Non Slum	Name of Beneficiary	Father's Name / Husband's Name	Holding No./Address	Category		Gender	Adhaar No.	Mob No.	Photo
						General/S.C./O.B. C./S.T.	Minority				
30	7	(SC 18) RASORAH PASCHIMPAR A	NIRMAL KUMAR GHOSH	BIPAD BHANJAN GHOSH	104/114, RASORAH	GENERAL	NO.	M	902955044623	9564296022	



CHAIRMAN
KANDI MUNICIPALITY

PMAY (HFA- 2019-20)









BENEFICIARY LIST OF KANDI MUNICIPALITY

Sl. No.	Ward No	SLUM/Non Slum	Name of Beneficiary	Father's Name / Husband's Name	Holding No./Address	Category		Gender	Adhaar No.	Mob No.	Photo
						General/S.C./O.B. C./S.T	Minority				
1	7	SC 49 RASORAH MUCHIPARA	KAILASH DAS	LT. MADHUSUDAN DAS	11/210, RASORAH	SC	NO.	M	38408012850 0	9932577731	
2	7	SC 49 RASORAH MUCHIPARA	SUNIL DAS	LT. DHIREN DAS	13/208, RASORAH	SC	NO.	M	71714496084 3	8373842905	
3	7	SC 49 RASORAH MUCHIPARA	HIRA DAS	LT. BHIM DAS	1/6, RASORAH	SC	NO.	F	83899934015 2	8170994530	



CHAIRMAN
KANDI MUNICIPALITY

BENEFICIARY LIST OF KANDI MUNICIPALITY

Sl. No.	Ward No	SLUM /Non Slum	Name of Beneficiary	Father's Name / Husband's Name	Holding No./Address	Category		Gender	Adhaar No.	Mob No.	Photo
						General/S.C./O. B.C./S.T	Minority				
1	8	GHASIPARA (0017)	SARIKA BIBI	MITHU SEKH	JEMO GHASIPARA BAGDANGA	NO	YES	F	807604140323	8768667079	
2	8	GHASIPARA (0017)	SOMSER SEKH	SAMSU SEKH	JEMO GHASIPARA BAGDANGA	NO	YES	M	402912825368	7423030251	
3	8	GHASIPARA (0017)	LAILA BIBI	IDRISH SEKH	JEMO GHASIPARA BAGDANGA	NO	YES	F	863529793669	8001171104	
4	8	GHASIPARA (0017)	ASLIMA KHATUN	GOLAM SURMIAN	JEMO GHASIPARA BAGDANGA	NO	YES	F	984830004078	9733996653	
5	8	GHASIPARA (0017)	AVESHA KHATUN	KHURSED SEKH	JEMO GHASIPARA BAGDANGA	NO	YES	F	422701930515	7001779507	
6	8	GHASIPARA (0017)	RUMISED KHA	LT. GOFUR KHA	JEMO GHASIPARA BAGDANGA	NO	YES	M	943521460700	9932916993	
7	8	GHASIPARA (0017)	TAHARANI BIBI	LT. MOMIRUDDIN SK	JEMO GHASIPARA BAGDANGA	NO	YES	F	343015207007	9734558817	
8	8	GHASIPARA (0017)	SERFUL SEKH	SERAJUL SEKH	JEMO GHASIPARA BAGDANGA	NO	YES	M	962264377115	75018485511	
9	8	GHASIPARA (0017)	KAMERUDDIN SEKH	LT. KEBIR SEKH	JEMO GHASIPARA BAGDANGA	NO	YES	M	390622197630	7872609067	









CHAIRMAN
KANDI MUNICIPALITY

Sl. No.	Ward No	SLUM /Non Slum	Name of Beneficiary	Father's Name / Husband's Name	Holding No./Address	Category		Gender	Adhaar No.	Mob No.	Photo
						General/S.C./O. B.C./S.T	Minority				
10	8	GHASIPARA (0017)	GOUTAM GHOSH	DILIP GHOSH	JEMO GHASIPARA BAGDANGA	NO	YES	M	349647658228	7001160840	
11	8	GHASIPARA (0017)	SERFUL SK	SAMSUDDIN SK	JEMO GHASIPARA BAGDANGA	NO	YES	M	489099523002	7303379916	
12	8	GHASIPARA (0017)	AKTARUN BIBI	IMARUDDIN SK	JEMO GHASIPARA BAGDANGA	NO	YES	F	654995294154	8348598638	











CHAIRMAN
KANDI MUNICIPALITY

PMAY (HFA - 2019-20)











BENEFICIARY LIST OF KANDI MUNICIPALITY

Sl. No.	Ward No	SLUM/ NON SLUM	Name of Beneficiary	Father's Name / Husband's Name	Holding No./Address	Category		Gender	Adhaar No.	Mob No.	Photo
						General/S.C./O.B. C./S.T	Minority				
1	8	SC018 UMAPARA	MANORUDDIN SK	LT. RAHIM SEKH	JEMO UMAPARA BAGDANGA	NO	YES	M	893293611275	9064486164	
2	8	SC018 UMAPARA	MASDAR SEKH	LT. JALIL SEKH	JEMO UMAPARA BAGDANGA	NO	YES	M	498227676196	9775058543	
3	8	SC018 UMAPARA	MANSUR SEKH	ABOL SEKH	JEMO UMAPARA BAGDANGA	NO	YES	M	672198138336	8436801039	
4	8	SC018 UMAPARA	HARADHAN SEKH ALIAS HARAI SEKH	LT. SABER SEKH ALIAS SAKER SEKH	JEMO UMAPARA BAGDANGA	NO	YES	M	248396656107	8101983458	
5	8	SC018 UMAPARA	MD. JAFAR ALI	LT. FAILA HAQUE SK	JEMO UMAPARA BAGDANGA	NO	YES	M	899914664658	9064033145	
6	8	SC018 UMAPARA	JAHANGIR ALAMI	HAYAT SEKH	JEMO UMAPARA BAGDANGA	NO	YES	M	853159692535	8001132722	
7	8	SC018 UMAPARA	MOHIRUDDIN KHAN	JINNAT KHAN	JEMO UMAPARA BAGDANGA	NO	YES	M	477555736362	7718429436	
8	8	SC018 UMAPARA	SAGAR MONDAL	LT. BINOY MONDAL	JEMO UMAPARA BAGDANGA	GENERAL	NO	M	661561986910	8001366191	
9	8	SC018 UMAPARA	SHYAMALI MONDAL	ASHOK MONDAL	JEMO UMAPARA BAGDANGA	GENERAL	NO	F	957259703597	7047933416	

CHAIRMAN
KANDI MUNICIPALITY

Sl. No.	Ward No	SLUM/ NON SLUM	Name of Beneficiary	Father's Name / Husband's Name	Holding No./Address	Category		Gender	Adhaar No.	Mob No.	Photo
						General/S.C./O.B. C./S.T	Minority				
10	8	SC018 UMAPARA	KABITA BIBI	MD SUKUR SK	JEMO UMAPARA BAGDANGA	NO	YES	M	745352812649	8637533542	
11	8	SC018 UMAPARA	TAPAN PAL	LT. BAMACHARAN PAL	JEMO UMAPARA BAGDANGA	GENERAL	NO	M	697667382299	8918135072	
12	8	SC018 UMAPARA	MANIMALA DEY	LT. KANAILAL DEY	JEMO UMAPARA BAGDANGA	OBC	NO	F	839832157523	8348007176	
13	8	SC018 UMAPARA	PANDAB SHARMA	LT. SATYA RANJAN SHARMA	JEMO UMAPARA BAGDANGA	OBC	NO	M	913304209130	9734129776	
14	8	SC018 UMAPARA	MARIYAM BIBI	MUSTAFA SK	JEMO UMAPARA BAGDANGA	NO	YES	F	37375605664	8967871014	
15	8	SC018 UMAPARA	HORAI SEKH	LT. RAHAMAT SEKH	JEMO UMAPARA BAGDANGA	NO	YES	M	325280133744	9635931959	
16	8	SC018 UMAPARA	SABER SEKH	LT. KATEB SEKH	JEMO UMAPARA BAGDANGA	NO	YES	M	890827723665	9734454360	
17	8	SC018 UMAPARA	ARIJIT MONDAL	SISIR MONDAL	JEMO UMAPARA BAGDANGA	GENERAL	NO	M	298625278804	9647494293	
18	8	SC018 UMAPARA	MADHABI MONDAL	DHRUBA MONDAL	JEMO UMAPARA BAGDANGA	GENERAL	NO	F	627755392124		
19	8	SC018 UMAPARA	NAJEM SEKH	LT. ABAL SEKH	JEMO UMAPARA BAGDANGA	NO	YES	M	894020286758	7797913027	

 ALI CHAIRMAN
 KANDI CHAIRMAN
 KANDI CHAIRMAN
 KANDI CHAIRMAN

Sl. No.	Ward No	SLUM/ NON SLUM	Name of Beneficiary	Father's Name / Husband's Name	Holding No./Address	Category		Gender	Adhaar No.	Mob No.	Photo
						General/S.C./O.B. C./S.T.	Minority				
20	8	SC018 UMAPARA	MAMATA HAZRA	SHIB SHANKAR HAZRA	JEMO UMAPARA BAGDANGA	SC	NO	F	322441061431	9641701446	
21	8	SC018 UMAPARA	SANOWAR SEKH	LT. BABOR ALI SEKH	JEMO UMAPARA BAGDANGA	NO	YES	M	335254700045	9083928103	
22	8	SC018 UMAPARA	HAREKRISHNA PAL	NITAL PAL	JEMO UMAPARA BAGDANGA	GENERAL	NO	M	503640899556	6294846028	
23	8	SC018 UMAPARA	HAKSED SK	ABOL SEKH	JEMO UMAPARA BAGDANGA	NO	YES	M	873708311586	6297228688	
24	8	SC018 UMAPARA	DALU SK	LT. KUDDUS SEKH	JEMO UMAPARA BAGDANGA	NO	YES	M	638361700332	9647446534	
25	8	SC018 UMAPARA	MONOHARA BIBI	LT. RAHIM SEKH	JEMO UMAPARA BAGDANGA	NO	YES	F	508466544343	9647159350	
26	8	SC018 UMAPARA	RAMJAN SK	ROUSAN SK	JEMO UMAPARA BAGDANGA	NO	YES	M	374072276476	6297735499	
27	8	SC018 UMAPARA	JAHANBI MONDAL	DEB KUMAR MONDAL	JEMO UMAPARA BAGDANGA	GENERAL	NO	F	597193267264		
28	8	SC018 UMAPARA	PRADIPTA DEY	MONTU DEY	JEMO UMAPARA BAGDANGA	GENERAL	NO	M	912984955201	9647540611	
29	8	SC018 UMAPARA	KHOKAN GHOSH	RAIKUMAR GHOSH	JEMO UMAPARA BAGDANGA	GENERAL	NO	M	653418240478	7977639894	

CHAIRMAN
KANDI MUNICIPALITY

PMAY (HFA- 2019-20)









BENEFICIARY LIST OF KANDI MUNICIPALITY

Sl. No.	Ward No	SLUM /Non Slum	Name of Beneficiary	Father's Name / Husband's Name	Holding No./Address	Category		Gender	Adhaar No.	Mob No.	Photo
						General/S.C./O.B. C./S.T	Minority				
1	8	SC019 MUCHIPARA	TAPAN DAS	LT. DULAL DAS	JEMO MUCHIPARA JEMO RAIBATI	SC	NO	M	344820257322	8768404577	
2	8	SC019 MUCHIPARA	SHYAMAL DAS	NIMAI DAS	JEMO MUCHIPARA JEMO RAIBATI	SC	NO	M	461745683613	8617384330	
3	8	SC019 MUCHIPARA	SANDHYA DAS	LT. TENU DAS	JEMO MUCHIPARA JEMO RAIBATI	SC	NO	F	273763020363	7430885867	
4	8	SC019 MUCHIPARA	DEBABRATA DAS	JIBEN DAS	JEMO MUCHIPARA JEMO RAIBATI	SC	NO	M	863303582538	8768171086	

CHAIRMAN
KANDI MUNICIPALITY

PMAY (HFA- 2019-20)





BENEFICIARY LIST OF KANDI MUNICIPALITY

Sl. No.	Ward No	SLUM / Non Slum	Name of Beneficiary	Father's Name / Husband's Name	Holding No./Address	Category		Gender	Adhaar No.	Mob No.	Photo
						General/S.C./O.B.C./S.T	Minority				
1	8	SC020 BAGANPARA	NANDA DULAL MONDAL	LT. RAMPRASAD MONDAL	JEMO BAGANPARA JEMO RAJBATI	GENERAL	NO	M	981646633938	7029542697	
2	8	SC020 BAGANPARA	PARESH NATH MONDAL	SASHANKA MONDAL	JEMO BAGANPARA JEMO RAJBATI	GENERAL	NO	M	366939212286	9593494868	
3	8	SC020 BAGANPARA	HARADHAN MONDAL	LT. KALIPADA MONDAL	JEMO BAGANPARA JEMO RAJBATI	GENERAL	NO	M	256102591314	7890292766	
4	8	SC020 BAGANPARA	MITHU GHOSH	KARTICK GHOSH	JEMO BAGANPARA JEMO RAJBATI	GENERAL	NO	F	682038100446	7864028119	
5	8	SC020 BAGANPARA	BHAKTIPADA MONDAL	LT. MAHADEB MONDAL	JEMO BAGANPARA JEMO RAJBATI	GENERAL	NO	M	223712918515	9134692919	
6	8	SC020 BAGANPARA	SHIB SHANKAR MONDAL	LT. JAGANNATH MONDAL	JEMO BAGANPARA JEMO RAJBATI	GENERAL	NO	M	397397715689	9434881231	
7	8	SC020 BAGANPARA	SWAPAN MONDAL	MRITYUNJOY MONDAL	JEMO BAGANPARA JEMO RAJBATI	GENERAL	NO	M	652598300384	7001273389	
8	8	SC020 BAGANPARA	GOURANGA MONDAL	LT. JOYGOPAL MONDAL	JEMO BAGANPARA JEMO RAJBATI	GENERAL	NO	M	445700687903	8918778174	
9	8	SC020 BAGANPARA	BRAHMADEV MONDAL	LT. RENUPADA MONDAL	JEMO BAGANPARA JEMO RAJBATI	GENERAL	NO	M	997183979479	9609140838	

CHAIRMAN
KANDI MUNICIPALITY

PMAY (HFA- 2019-20)









BENEFICIARY LIST OF KANDI MUNICIPALITY

Sl. No.	Ward No	SLUM /Non Slum	Name of Beneficiary	Father's Name / Husband's Name	Holding No./Address	Category		Gender	Adhaar No.	Mob No.	Photo
						General/S.C./O.B. C./S.T	Minority				
1	8	SC021 GHOSHPARA	PALTU GHOSH	SUKUMAR GHOSH	JEMO BISWASPARA BAGDANGA	OBC	NO	M	712805291995	7063536049	
2	8	SC021 GHOSHPARA	BISWAJIT GHOSH	LT. BANSHI BADAN GHOSH	JEMO BISWASPARA BAGDANGA	OBC	NO	M	502015062797	9775508362	
3	8	SC021 GHOSHPARA	UNNATI GHOSH	PABON GHOSH	JEMO BISWASPARA BAGDANGA	OBC	NO	F	377286909493	7890292766	
4	8	SC021 GHOSHPARA	JIBAN GHOSH	AJOY GHOSH	JEMO BISWASPARA BAGDANGA	OBC	NO	M	775004140254	9593543562	
5	8	SC021 GHOSHPARA	DINABANDHU GHOSH	LT. BHABESH CHANDRA GHOSH	JEMO BISWASPARA BAGDANGA	OBC	NO	M	905613628795	9635315547	







CHAIRMAN
KANDI MUNICIPALITY

PMAY (HFA- 2019-20)

BENEFICIARY LIST OF KANDI MUNICIPALITY

Sl. No.	Ward No	SLUM /Non Slum	Name of Beneficiary	Father's Name / Husband's Name	Holding No./Address	Category		Gender	Adhaar No.	Mob No.	Photo
						General/S.C./O.B. C./S.T.	Minority				
1	8	SC 050 NILKANTHAPUR R	PARTHA SARATHI MONDAL	ROBINDRANATH MONDAL	JEMO NILKANTHAPUR JEMO RAJBATI	GENERAL	NO	M	908271341228	9800034199	
2	8	SC 050 NILKANTHAPUR R	BENUKAR CHOWDHURY	LT. GANAPATI CHOWDHURY	JEMO NILKANTHAPUR JEMO RAJBATI	GENERAL	NO	M	360152307469	8250888465	
3	8	SC 050 NILKANTHAPUR R	RANJIT MONDAL	LT. NARAYAN MONDAL	JEMO NILKANTHAPUR JEMO RAJBATI	GENERAL	NO	M	908527559885	7384604445	
4	8	SC 050 NILKANTHAPUR R	CHAND BADAN PAL	LT. KAMALAKANTA PAL	JEMO NILKANTHAPUR JEMO RAJBATI	GENERAL	NO	M	299578981365	9732625459	
5	8	SC 050 NILKANTHAPUR R	CHHABI BISWAS	PRAKASH CHANDRA BISWAS	JEMO NILKANTHAPUR JEMO RAJBATI	OBC	NO	M	545080667591	6294824221	
6	8	SC 050 NILKANTHAPUR R	BABON SHARMA	BHUBAN SHARMA	JEMO NILKANTHAPUR JEMO RAJBATI	OBC	NO	M	331744865863	9733806772	
7	8	SC 050 NILKANTHAPUR R	BHASKAR GHOSH	LT. MANTU GHOSH	JEMO NILKANTHAPUR JEMO RAJBATI	OBC	NO	M	977831272013	9635447308	
8	8	SC 050 NILKANTHAPUR R	RABIN MONDAL	SANJOY MONDAL	JEMO NILKANTHAPUR JEMO RAJBATI	GENERAL	NO	M	836270463720	9046636469	
9	8	SC 050 NILKANTHAPUR R	ABHIJIT DAS	LT. GANDHI DAS	JEMO NILKANTHAPUR JEMO RAJBATI	OBC	NO	M	965518406893	9233122626	











CHAIRMAN
KANDI MUNICIPALITY

Sl. No.	Ward No	SLUM / Non Slum	Name of Beneficiary	Father's Name / Husband's Name	Holding No./Address	Category		Gender	Adhaar No.	Mob No.	Photo
						General/S.C./O.B. C./S.T	Minority				
10	8	SC 050 NILKANTHAPUR R	SUDEB MONDAL	SATYA NARAYAN MONDAL	JEMO NILKANTHAPUR JEMO RAIBATI	GENERAL	NO	M	785412052189	8514907476	
11	8	SC 050 NILKANTHAPUR R	JITEN DAS	LT. JANARDAN DAS	JEMO NILKANTHAPUR JEMO RAIBATI	GENERAL	NO	M	498510541521	6295657435	
12	8	SC 050 NILKANTHAPUR R	BAIDYANATH PAL		JEMO UMAPARA BAGDANGA	GENERAL	NO	M	648458022501	7547959607	
13	8	SC 050 NILKANTHAPUR R	DASARATH MONDAL	LT. ABHAYKALI MONDAL	JEMO UMAPARA BAGDANGA	GENERAL	NO	M	625832115469	9733807407	
14	8	SC 050 NILKANTHAPUR R	ASIM MONDAL	LT. BASUDEB MONDAL	JEMO UMAPARA BAGDANGA	GENERAL	NO	M	544902328512	876863086	
15	8	SC 050 NILKANTHAPUR R	KANCHAN DAS	BAHSHI BADAN DAS	JEMO UMAPARA BAGDANGA	OBC	NO	M	756552920762	6295199780	











CHAIRMAN
KANDI MUNICIPALITY

PMAY (HFA - 2019-20)

BENEFICIARY LIST OF KANDI MUNICIPALITY

Sl. No.	Ward No	SLUM /Non Slum	Name of Beneficiary	Father's Name / Husband's Name	Holding No./Address	Category		Gender	Adhaar No.	Mob No.	Photo
						General/S.C./O.B. C./S.T	Minority				
1	9	BOURIPARA	BIKASH HALDER	LT. GOPAL HALDER	NEW	S.C.	NO	M	738444186222		
2	9	BOURIPARA	KALYANI BAGDI	LT. MEGHNATH BAGDI	NEW	S.C.	NO	F	729963628968		
3	9	BOURIPARA	DEBRATTA GANGULI	DILIP GANGULI	NEW	S.C.	NO	M	832222249864		
4	9	BOURIPARA	TAPAN DALUI	MANIK DALUI	NEW	S.C.	NO	M	443884103615	7679142313	
5	9	BOURIPARA	ADITYA THANDER	SUNIL KR. THANDER	NEW	S.C.	NO	M	728269598422		
6	9	BOURIPARA	BISWANATH DALUI	CHANDU DALUI	NEW	S.C.	NO	M	435987883734	9641622996	
7	9	BOURIPARA	AMBIKA PRASAD SAHA	ABHAYPADA SAHA	NEW	S.C.	NO	M	706622784420		
8	9	BOURIPARA	SWAPAN KAR	LT. TARAPADA KAR	NEW	S.C.	NO	M	979538344894		
9	9	BOURIPARA	KANIKA SINGHA	LT. AMAR SINGHA	NEW	GENERAL	NO	F	207773310014	9002912565	

CHAIRMAN
KANDI MUNICIPALITY

Sl. No.	Ward No	SLUM /Non Slum	Name of Beneficiary	Father's Name / Husband's Name	Holding No./Address	Category		Gender	Adhaar No.	Mob No.	Photo
						General/S.C./O.B. C./S.T	Minority				
10	9	BOURIPARA	SARASWATI CHOUHDURY	LT JAYANTA CHOUHDURY	NEW	GENERAL	NO	F	776898616957	9735392461	
11	9	BOURIPARA (022)	DEBASIS MANDAL	JALADHAR MANDAL	NEW	GENERAL	NO	M	803624252015		
12	9	BOURIPARA (022)	TARIT HAZRA	LT. CHITTARANJAN HAZRA	NEW	S.C.	NO	M	660842795185		
13	9	BOURIPARA (022)	NAMITA DALUI	DEBU DALUI	NEW	S.C.	NO	F	401084161152		
14	9	BOURIPARA (022)	PRAVAT GHOSH	ANANDA GHOSH	NEW	GENERAL	NO	M	336709261906		
15	9	BOURIPARA (022)	PABIR DALUI	KALIPADA DALUI	NEW	S.C.	NO	M	613806089089	8101942495	
16	9	BOURIPARA (022)	BARUN MISTRI	LT. RAKHAN MISTRI	NEW	OBC	NO	M	237114395273		
17	9	BOURIPARA (022)	BYASDEB HALDER	BISWANATH HALDER	NEW	S.C.	NO	M	809704526861		
18	9	BOURIPARA (022)	RITA CHOWDHAURI	LT. PRALAY CHOWDHURY	NEW	GENERAL	NO	F	817612097304		
19	9	BOURIPARA (022)	BISWANATH MANDAL	RENUPADA MANDAL	NEW	GENERAL	NO	M	774306384092		





CHAIRMAN
KANDI MUNICIPALITY

Sl. No.	Ward No	SLUM /Non Slum	Name of Beneficiary	Father's Name / Husband's Name	Holding No./Address	Category		Gender	Adhaar No.	Mob No.	Photo
						General/S.C./O.B. C./S.T	Minority				
20	9	BOURIPARA (022)	ANIMA MANDAL	NARUGOPAL MANDAL	NEW	GENERAL	NO	F	499440418551		

 CHAIRMAN
 KANDI MUNICIPALITY

PMAY (HFA- 2019-20)









BENEFICIARY LIST OF KANDI MUNICIPALITY

Sl. No.	Ward No	SLUM /Non Slum	Name of Beneficiary	Father's Name / Husband's Name	Holding No./Address	Category		Gender	Adhaar No.	Mob No.	Photo
						General/S.C./O. B.C./S.T	Minority				
1	9	HAZRAPARA(0 23)	BALAK HAZRA	LT. BANSHI BADAN HAZRA	NEW	S.C.	NO	M	655201358615		
2	9	HAZRAPARA(0 23)	AKSHAY KUMAR HAZRA	LT. DULAL HAZRA	NEW	S.C.	NO	M	547522667776		
3	9	HAZRAPARA(0 23)	SAKHI GOPAL HAZRA	LT. NARAYAN CHANDRA HAZRA	NEW	S.C.	NO	M	528878336492		
4	9	HAZRAPARA(0 23)	ANUPAMA KAR	LT. DHARMADAS KAR	NEW	OBC	NO	F	878982421732		
5	9	HAZRAPARA(0 23)	DIBAKAR SINGHA	LT. MANAB KUMAR SINHA	NEW	GENERAL	NO	M	247346417967		
6	9	HAZRAPARA(0 23)	PRADIP SAHA	UJJIWAL SAHA	NEW	S.C.	NO	M	522726253280	7063609560	
7	9	HAZRAPARA(0 23)	REBARANI PRAMANIK	TRIDIP PRAMANIK	NEW	GENERAL	NO	F	674968195534	973587876906	
8	9	HAZRAPARA(0 23)	SIKHA DAS	BIJAY DAS	NEW	GENERAL	NO	F	878207579136		

CHAIRMAN
KANDI MUNICIPALITY









PMAY (HFA- 2019-20)

BENEFICIARY LIST OF KANDI MUNICIPALITY



Sl. No.	Ward No	SLUM /Non Slum	Name of Beneficiary	Father's Name / Husband's Name	Holding No./Address	Category		Gender	Adhaar No.	Mob No.	Photo
						General/S.C./O.B. C./S.T	Minority				
1	9	RAGHUNATH PUR(024)	CHHYA PAL BISWAS	SAMIR BISWAS	NEW	GENERAL	NO	F	678224433925		
2	9	RAGHUNATH PUR(024)	SUKUMAR RAJAK	SHAKTIPADA RAJAK	NEW	S.C.	NO	M	495760844045	7908510187	
3	9	RAGHUNATH PUR(024)	PRANAB RAJAK	HATU RAJAK	NEW	S.C.	NO	M	807195755847	9851541102	
4	9	RAGHUNATH PUR(024)	KARTICK SAHA	MATAR SAHA	NEW	S.C.	NO	M	882018870249	9126145688	
5	9	RAGHUNATH PUR(024)	SANJAY SINGHA	BHAKTI BHUSAN SINGHA	NEW	GENERAL	NO	M	639423749293	7076798783	
6	9	RAGHUNATH PUR(024)	MANARANJAN DALUI	KALIPADA DALUI	NEW	GENERAL	NO	M	290817800249	7384246377	
7	9	RAGHUNATH PUR(024)	KRISHNA BITTER	DHANANJOY BITTER	NEW	S.C.	NO	M	402019593446		
8	9	RAGHUNATH PUR(024)	SHIB SHANKAR PATRA	DHAKSHINA CHARAN PATRA	NEW	GENERAL	NO	M	581362464218		



CHAIRMAN
KANDI MUNICIPALITY

Sl. No.	Ward No	SLUM /Non Slum	Name of Beneficiary	Father's Name / Husband's Name	Holding No./Address	Category		Gender	Adhaar No.	Mob No.	Photo
						General/S.C./O.B. C./S.T	Minority				
9	9	RAGHUNATH PUR(024)	PRADIP CHOWDHURY	BIMANESH CHOWDHURY	NEW	GENERAL	NO	M	232472732437		
10	9	RAGHUNATH PUR(024)	SHANTI GHOSH	HRIKRSH GHOSH	NEW	GENERAL	NO	M	567545611937	6296955695	
11	9	RAGHUNATH PUR(024)	SHASHANKA DUTTA	SWAPAN DUTTA	NEW	GENERAL	NO	M	862010466200	8927172489	
12	9	RAGHUNATH PUR(024)	HIRAN GHOSH	DHANUPADA GHOSH	NEW	GENERAL	NO	M	339999401072	8101942495	
13	9	RAGHUNATH PUR(024)	ANNAPURNA GHOSH	SHYAMAL GHOSH	NEW	GENERAL	NO	M	250106535166	9064614029	
14	9	RAGHUNATH PUR(024)	RAMAN DAS	BALARAM DAS	NEW	GENERAL	NO	M	254787805752		
15	9	RAGHUNATH PUR(024)	KRISHNA CHANDRA PRODHAN	NARUGOPAL PRODHAN	NEW	S.C.	NO	M	918006955687	8918029318	
16	9	RAGHUNATH PUR(024)	TAPAN PRADHAN	AJOY PRADHAN	NEW	S.C.	NO	M	295226486790		
17	9	RAGHUNATH PUR(024)	PRASANTA DHAR	GANESH DHAR	NEW	GENERAL	NO	M	821553001925		









CHAIRMAN
KANDI MUNICIPALITY

Sl. No.	Ward No	SLUM /Non Slum	Name of Beneficiary	Father's Name / Husband's Name	Holding No./Address	Category		Gender	Adhaar No.	Mob No.	Photo
						General/S.C./O.B. C./S.T	Minority				
18	9	RAGHUNATH PUR(024)	SUBHENDU KR, DUTTA	SISIR KR. DUTTA	NEW	GENERAL	NO	M	472059300541		
19	9	RAGHUNATH PUR(024)	NIMAI GHOSH	PRAN KRISHNA GHOSH	NEW	GENERAL	NO	M	616904878906		
20	9	RAGHUNATH PUR(024)	ARUN CHANDRA	TRILAKESH CHANDRA	NEW	GENERAL	NO	M	739580375070		





CHAIRMAN
KANDI MUNICIPALITY

PMAY (HFA- 2019-20)

BENEFICIARY LIST OF KANDI MUNICIPALITY

Sl. No.	Ward No	SLUM /Non Slum	Name of Beneficiary	Father's Name / Husband's Name	Holding No./Address	Category		Gender	Adhaar No.	Mob No.	Photo
						General/S.C./O.B.C./S.T	Minority				
1	9	TANTIPARA (025)	TARUN MISTRI	DHIREN MISTRI	NEW	GENERAL	NO	M	825415147225		
2	9	TANTIPARA (025)	BASANTI BAJPAYEE	CHHABINATH BAJPAYEE	NEW	GENERAL	NO	F	634424747017		
3	9	TANTIPARA (025)	GANAPATI DAS	NILKAMAL DAS	NEW	GENERAL	NO	M	297738639865	9547322478	
4	9	TANTIPARA (025)	DEBASHISH DUTTA	KAMALA PRASAD DUTTA	NEW	GENERAL	NO	M	836142874137		
5	9	TANTIPARA (025)	BARUN PAL	BANKIM PAL	NEW	GENERAL	NO	M	799118850962		
6	9	TANTIPARA (025)	CHITRA DUTTA	DIPAK DUTTA	NEW	GENERAL	NO	F	896387469596		
7	9	TANTIPARA (025)	SUNITA DALAL	BAKESWAR DALAL	NEW	OBC	NO	F	938758831634		
8	9	TANTIPARA (025)	SUKUMAR HAZRA	SHIBU HAZRA	NEW	GENERAL	NO	M	723948422825		











 CHAIRMAN
 KANDI MUNICIPALITY

Sl. No.	Ward No	SLUM /Non Slum	Name of Beneficiary	Father's Name / Husband's Name	Holding No./Address	Category		Gender	Adhaar No.	Mob No.	Photo
						General/S.C./O.B.C./S.T	Minority				
9	9	TANTIPARA (025)	BARUN MONDAL	RAMPADA MONDAL	NEW	GENERAL	NO	M	926069207659		
10	9	TANTIPARA (025)	RUPA PAL	NITAI PAL	NEW	GENERAL	NO	F	753558095802	9775342441	
11	9	TANTIPARA (025)	NIMAI CHANDRA MONDAL	RAMAPATI MONDAL	NEW	GENERAL	NO	M	333980653899		
12	9	TANTIPARA (025)	ASHOKE CHATTERJEE	SUNIL CHATTERJEE	NEW	GENERAL	NO	M	471201063378		











CHAIRMAN
KANDI MUNICIPALITY

PMAY (HFA- 2019-20)











BENEFICIARY LIST OF KANDI MUNICIPALITY

Sl. No.	Ward No	SLUM /Non Slum	Name of Beneficiary	Father's Name / Husband's Name	Holding No./Address	Category		Gender	Adhaar No.	Mob No.	Photo
						General/S.C./O.B. C./S.T	Minority				
1	10	SC 026 KONAIPARA GHOSHPARA	UTTAM GHOSH	KARTIK GHOSH	RUPPUR GHOSHPARA	O B C	NO	M	576985546157	7647047568	
2	10	SC 026 KONAIPARA GHOSHPARA	DEB GHOSH	SHYAM GHOSH	RUPPUR GHOSHPARA	O B C	NO	M	674381184911	9382524809	
3	10	SC 026 KONAIPARA GHOSHPARA	CHANCHAL GHOSH	JOPEN GHOSH	RUPPUR GHOSHPARA	O B C	NO	M	565452567860	9775439140	
4	10	SC 026 KONAIPARA GHOSHPARA	SAPTAM KONAI	SHYAMACHARAN KONAI	RUPPUR GHOSHPARA	SC	NO	M	294209952838	8906315686	
5	10	SC 026 KONAIPARA GHOSHPARA	SITARAM MONDAL	LT. KHUDU MONDAL	RUPPUR GHOSHPARA	SC	NO	M	734522063298	9153590156	
6	10	SC 026 KONAIPARA GHOSHPARA	GANESH RAUBANSHI	BISHU RAJBANSHI	RUPPUR KONAIPARA	SC	NO	M	841958693195	8372095630	
7	10	SC 026 KONAIPARA GHOSHPARA	ANUP KUMAR DEY	LT. SITAPATI DEY	RUPPUR KONAIPARA	GENERAL	NO	M	800701706578	9002815452	
8	10	SC 026 KONAIPARA GHOSHPARA	SOURAV MUKHERIEE	DEBIPRASAD MUKHERIEE	RUPPUR KONAIPARA	GENERAL	NO	M	508499139883	9474169720	
9	10	SC 026 KONAIPARA GHOSHPARA	AMIT CHAKRABORTY	DIPAK CHAKRABORTY	RUPPUR KONAIPARA	GENERAL	NO	M	839160575329	9046535636	











CHAIRMAN
KANDI MUNICIPALITY

Sl. No.	Ward No	SLUM /Non Slum	Name of Beneficiary	Father's Name / Husband's Name	Holding No./Address	Category		Gender	Adhaar No.	Mob No.	Photo
						General/S.C./O.B.C./S.T	Minority				
10	10	SC 026 KONAIPARA GHOSHARA	KAPIL CHATTERJEE	DEBASISH CHATTERJEE	RUPPUR KONAIPARA	GENERAL	NO	M	299338272311	9732697514	
11	10	SC 026 KONAIPARA GHOSHARA	SUDEB GHOSH	LT. RAMPADA GHOSH	RUPPUR GHOSHARA	O.B.C.	NO	M	860357278101	9851119143	
12	10	SC 026 KONAIPARA GHOSHARA	PRADIP BANERJEE	SANJIT BANERJEE	RUPPUR KONAIPARA	GENERAL	NO	M	215203266018	8391063010	
13	10	SC 026 KONAIPARA GHOSHARA	ANUP GHOSH	ANANDA GHOSH	RUPPUR GHOSHARA	O.B.C.	NO	M	7509597237095	6297029075	
14	10	SC 026 KONAIPARA GHOSHARA	MINTU GHOSH	LT. BRAJA GHOSH	RUPPUR GHOSHARA	O.B.C.	NO	M	206989041525	9647141875	
15	10	SC 026 KONAIPARA GHOSHARA	BACHCHAN GHOSH	BANYESWAR GHOSH	RUPPUR GHOSHARA	O.B.C.	NO	M	348535392405	7908865466	
16	10	SC 026 KONAIPARA GHOSHARA	BENUKAR MONDAL	LT. MAKHAN MONDAL	RUPPUR KONAIPARA	SC	NO	M	760828946125	9547238604	
17	10	SC 026 KONAIPARA GHOSHARA	PROBIR MONDAL	LT. NARAYAN MONDAL	RUPPUR KONAIPARA	SC	NO	M	805616332635	6294884546	
18	10	SC 026 KONAIPARA GHOSHARA	BIPAD GHOSH	LT. RAICHARAN GHOSH	RUPPUR GHOSHARA	O.B.C.	NO	M	700809399564	8946325634	
19	10	SC 026 KONAIPARA GHOSHARA	BABAN DAS	JAGANNATH DAS	RUPPUR GHOSHARA	GENERAL	NO	M	858354710869	6295594795	



CHAIRMAN
KANDI MUNICIPALITY

Sl. No.	Ward No	SLUM /Non Slum	Name of Beneficiary	Father's Name / Husband's Name	Holding No./Address	Category		Gender	Adhaar No.	Mob No.	Photo
						General/S.C./O.B.C./S.T	Minority				
20	10	SC 026 KONAIPARA GHOSHPARA	SAMPA MONDAL	SIBU MONDAL	RUPPUR GHOSHPARA	SC	NO	F	960998226695	8170914829	
21	10	SC 026 KONAIPARA GHOSHPARA	BIBHAS DAS	UTTAM DAS	RUPPUR GHOSHPARA	O.B.C	NO	M	821772565059	7384066247	
22	10	SC 026 KONAIPARA GHOSHPARA	TUSHER CHATTARAJ	LT. SHYAMAL CHATTARAJ	RUPPUR	GENERAL	NO	M	255311918708	7602595440	
23	10	SC 026 KONAIPARA GHOSHPARA	BHIM MONDAL	SHYAM MONDAL	RUPPUR KONAIPARA	SC	NO	M	254030230522	7432087635	
24	10	SC 026 KONAIPARA GHOSHPARA	MITHUN DAS	RAJKUMAR DAS	RUPPUR GHOSHPARA	O.B.C	NO	M	828390895180	7384635412	
25	10	SC 026 KONAIPARA GHOSHPARA	RUBI CHATTEREE	LT. PRANAB CHATTERIEE	RUPPUR KONAIPARA	GENERAL	NO	M	234633211652	8123429123	
26	10	SC 026 KONAIPARA GHOSHPARA	ATIT GHOSH	KAMAL GHOSH	RUPPUR GHOSHPARA	O.B.C	NO	M	914467166638	9547160361	
27	10	SC 026 KONAIPARA GHOSHPARA	TARAK NATH MONDAL	LT. KAMAL MONDAL	RUPPUR KONAIPARA	SC	NO	M	973949890843	7797937129	
28	10	SC 026 KONAIPARA GHOSHPARA	DUSHASAN GHOSH	LT. ROY GHOSH	RUPPUR GHOSHPARA	O.B.C	NO	M	766790766680	7076264117	
29	10	SC 026 KONAIPARA GHOSHPARA	DIPANKAR MONDAL	BAPU MONDAL	RUPPUR KONAIPARA	SC	NO	M	893618643017	9002204314	

CHAIRMAN
KANDI MUNICIPALITY

Sl. No.	Ward No	SLUM /Non Slum	Name of Beneficiary	Father's Name / Husband's Name	Holding No./Address	Category		Gender	Adhaar No.	Mob No.	Photo
						General/S.C./O.B.C./S.T	Minority				
30	10	SC 026 KONAIPARA GHOSHPARA	MADHUSUDAN DAS	LT. GOUR GOPAL DAS	RUPPUR KONAIPARA	O.B.C	NO	M	408714302534	9735397277	
31	10	SC 026 KONAIPARA GHOSHPARA	KAJAL MONDAL	BINOY MONDAL	RUPPUR KONAIPARA	SC	NO	M	696205772190	9732767037	
32	10	SC 026 KONAIPARA GHOSHPARA	DEBASHIS CHATTARAJ	LT. SHYAMAL CHATTARAJ	RUPPUR KONAIPARA	GENERAL	NO	M	703415597104	9635587062	
33	10	SC 026 KONAIPARA GHOSHPARA	BANESWAR MAJUMDAR	LT. ANADI MAJUMDAR	RUPPUR KONAIPARA	GENERAL	NO	M	407679905939	9434336092	
34	10	SC 026 KONAIPARA GHOSHPARA	LATA DAS	RANJIT DAS	RUPPUR KONAIPARA	O.B.C	NO	F	238359826254	6297627227	
35	10	SC 026 KONAIPARA GHOSHPARA	PROBHAT MONDAL	LT. NARAYAN MONDAL	RUPPUR KONAIPARA	SC	NO	M	981886902677	9775612515	
36	10	SC 026 KONAIPARA GHOSHPARA	BAPPA MONDAL	PROSANTA MONDAL	RUPPUR KONAIPARA	SC	NO	M	397251844370	9732293692	
37	10	SC 026 KONAIPARA GHOSHPARA	CHHOTON MONDAL	SANTOSH MONDAL	RUPPUR KONAIPARA	SC	NO	M	553860684701	8373802424	
38	10	SC 026 KONAIPARA GHOSHPARA	SOMNATH MONDAL	LT. MAKAL MONDAL	RUPPUR KONAIPARA	SC	NO	M	548054540071	9832215693	
39	10	SC 026 KONAIPARA GHOSHPARA	PRABIR ROOJ	SUDHIR ROOJ	RUPPUR GHOSHPARA	O.B.C	NO	M	806541801861	6297013649	

CHAIRMAN
KANDI MUNICIPALITY









Sl. No.	Ward No	SLUM/Non Slum	Name of Beneficiary	Father's Name / Husband's Name	Holding No./Address	Category		Gender	Adhaar No.	Mob No.	Photo
						General/S.C./O.B. C./S.T	Minority				
40	10	SC 026 KONAIKARA GHOSHAPARA	KRISHNA PRASAD MUKHERJEE	SATYANARAYAN MUKHERJEE	RUPPUR HABLIPAR	GENERAL	NO	M	832006828889	8001638029	

CHAIRMAN
KANDI MUNICIPALITY









PMAY (HFA- 2019-20)

CORPORATION/MUNICIPALITY/N.A.A./N.N.A.







BENEFICIARY LIST OF

Sl. No.	Ward No	SLUM /Non Stum	Name of Beneficiary	Father's Name / Husband's Name	Holding No./Address	Category		Gender	Adhaar No.	Mob No.	Photo
						General/S.C./O.B. C./S.T	Minority				
3	10	SC,027 HABLIIPARA	HARADHAN BAGDI	DIBAKAR BAGDI	RUPPUR HABLIPAR	SC	NO	M	747394825694	7029431151	
2	10	SC,027 HABLIIPARA	BHADU BAGDI	NIRANJAN BAGDI	RUPPUR HABLIPAR	SC	NO	M	519619987847	9547171900	
3	10	SC,027 HABLIIPARA	SUKHEN DALUI	LT. TEJEN DALUI	RUPPUR HABLIPAR	SC	NO	M	789939974784	8918826944	
4	10	SC,027 HABLIIPARA	PRADIP KUMAR DAS	JAGANNATH DAS	RUPPUR HABLIPAR	SC	NO	M	592648417403	9547024525	
5	10	SC,027 HABLIIPARA	NIBARAN PAL	LT. SANKAR PAL	RUPPUR HABLIPAR	GENERAL	NO	M	749083336215	8001847423	
6	10	SC,027 HABLIIPARA	KASHINATH PAL	LT. EKKARI PAL	RUPPUR HABLIPAR	GENERAL	NO	M	782475774361	8906091952	
7	10	SC,027 HABLIIPARA	RANJAN DALUI	LT. MANTU DALUI	RUPPUR HABLIPAR	SC	NO	M	720256802751	8972598573	
8	10	SC,027 HABLIIPARA	ASHOK BAGDI	BALAI BAGDI	RUPPUR HABLIPAR	SC	NO	M	314477273556	9932892143	
9	10	SC,027 HABLIIPARA	BISHU BAGDI	LT. SITARAM BAGDI	RUPPUR HABLIPAR	SC	NO	M	506133265407	9641478294	

CHAIRMAN
KANDI MUNICIPALITY

Sl. No.	Ward No	SLUM /Non Slum	Name of Beneficiary	Father's Name / Husband's Name	Holding No./Address	Category		Gender	Adhaar No.	Mob No.	Photo
						General/S.C./O.B. C./S.T	Minority				
10	10	SC.027 HABLIIPARA	UTTARA FULMALI	BISWAJIT FULMALI	RUPPUR HABLIPAR	SC	NO	M	318516229218	7679879771	
11	10	SC.027 HABLIIPARA	BISWAJIT BAGDI	SOVAKAR BAGDI	RUPPUR HABLIPAR	SC	NO	M	899587725819	8337889270	
12	10	SC.027 HABLIIPARA	SAMAR KAIBARTYA	KHUDIRAM KAIBARTYA	RUPPUR HABLIPAR	SC	NO	M	331442397409	7407964826	
13	10	SC.027 HABLIIPARA	BISWAJIT DAS	LT. PRANKUMAR DAS	RUPPUR HABLIPAR	GENERAL	NO	M	608152736567	6296454738	
14	10	SC.027 HABLIIPARA	RAJYADHAR MONDAL	ANIL MONDAL	RUPPUR HABLIPAR	SC	NO	M	655527416940	9564155186	
15	10	SC.027 HABLIIPARA	SAKSHIGOPAL BAGDI	LT. ANUKUL BAGDI	RUPPUR HABLIPAR	SC	NO	M	905632648420	9735849653	
16	10	SC.027 HABLIIPARA	BARUN BITTEL	LT. NABAKUMAR BITTEL	RUPPUR HABLIPAR	SC	NO	M	306665849715	7864004163	
17	10	SC.027 HABLIIPARA	JADU BITTEL	JAGANNATH BITTAR	RUPPUR HABLIPAR	SC	NO	M	762312879213	9679778046	
18	10	SC.027 HABLIIPARA	UTTAM BAGDI	NIRANJAN BAGDI	RUPPUR HABLIPAR	SC	NO	M	987307276166	9647515770	
19	10	SC.027 HABLIIPARA	ILA BITTAR	LT. JOYDEB BITTAR	RUPPUR HABLIPAR	SC	NO	R	906597861891	8436920933	











CHAIRMAN
KANDI MUNICIPALITY

Sl. No.	Ward No	SLUM /Non Slum	Name of Beneficiary	Father's Name / Husband's Name	Holding No./Address	Category		Gender	Adhaar No.	Mob No.	Photo
						General/S.C./O.B. C./S.T	Minority				
20	10	SC-027 HABLIIPARA	MAMATA DAS	RONI DAS	RUPPUR HABLIPAR	S.C	NO	F	517167120811	8592443235	
21	10	SC-027 HABLIIPARA	BHAGIRATH MISTRI	LT. SASTI MISTRI	RUPPUR HABLIPAR	O.B.C	NO	M	315215313673	9126324352	
22	10	SC-027 HABLIIPARA	RAKSHAKAR DAS	LT. ANIL KUMAR DAS	RUPPUR HABLIPAR	S.C	NO	M	916394642391	8632453210	
23	10	SC-027 HABLIIPARA	TAPAN KUMAR KAIBARTTA	RAICHARAN KAIBARTTA	RUPPUR HABLIPAR	S.C	NO	M	406357162122	8145242743	
24	10	SC-027 HABLIIPARA	NAMITA GHOSH	DUSHASAN GHOSH	RUPPUR HABLIPAR	O.B.C	NO	F	466906577814	8256326325	
25	10	SC-027 HABLIIPARA	UJJWAL DAS	DEBNATH DAS	RUPPUR HABLIPAR	GENERAL	NO	M	83643669572	8436484497	









CHAIRMAN
KANDI MUNICIPALITY

PMAY (HFA- 2019-20)

BENEFICIARY LIST OF KANDI MUNICIPALITY

Sl. No.	Ward No	SLUM /Non Slum	Name of Beneficiary	Father's Name / Husband's Name	Holding No./Address	Category		Gender	Adhaar No.	Mob No.	Photo
						General/S.C./O.B. C./S.T.	Minority				
1	10	SC 028 HARISAGARP AR	SAMIR KUMAR DAS	KASHINATH DAS	HARISAGAR PAR	SC	NO	M	251493378061	9475511744	
2	10	SC 028 HARISAGARP AR	BISWANATH HAZRA	KUMAR HAZRA	HARISAGAR PAR	SC	NO	M	395158108834	9343422921	
3	10	SC 028 HARISAGARP AR	BHIM BITTAR	LT. SADHAN BITTAR	HARISAGAR PAR	SC	NO	M	873447289914	7797035444	
4	10	SC 028 HARISAGARP AR	UJJWAL HALDER	DHULUPADA HALDER	HARISAGAR PAR	SC	NO	M	440192088393	9564419760	
5	10	SC 028 HARISAGARP AR	PIJUSH MUKHERJEE	ASHOK MUKHERJEE	HARISAGAR PAR	GENERAL	NO	M	840117376474	9064203810	
6	10	SC 028 HARISAGARP AR	CHANDANA DAS	SAJAL DAS	HARISAGAR PAR	GENERAL	NO	F	951896896675	9434530548	
7	10	SC 028 HARISAGARP AR	MALAY MAHANTA	GORACHAND MAHANTA	HARISAGAR PAR	SC	NO	M	283162545087	8101700517	
8	10	SC 028 HARISAGARP AR	SAMIR BISWAS	SUDHIR BISWAS	HARISAGAR PAR	SC	NO	M	282918430065	8348667499	
9	10	SC 028 HARISAGARP AR	ASHISH HAZRA	KUMAR CH. HAZRA	HARISAGAR PAR	SC	NO	M	361823470129	9547112276	





CHAIRMAN
KANDI MUNICIPALITY

Sl. No.	Ward No	SLUM /Non Slum	Name of Beneficiary	Father's Name / Husband's Name	Holding No./Address	Category		Gender	Adhaar No.	Mob No.	Photo
						General/S.C./O.B. C./S.T	Minority				
10	10	SC 028 HARISAGARP AR	GOURANGO BITTAR	SHYAMAL BITTAR	HARISAGAR PAR	SC	NO	M	406832587830	8389885379	
11	10	SC 028 HARISAGARP AR	RAMKRISHNA MONDAL	LT. DHARANIDHAR MONDAL	HARISAGAR PAR	GENERAL	NO	M	913276681512	7679032636	
12	10	SC 028 HARISAGARP AR	KANIKA MUKHERJEE	GOPAN MUKHERJEE	HARISAGAR PAR	GENERAL	NO	F	998021466443	8370874210	
13	10	SC 028 HARISAGARP AR	NANDADJUL DAS	LT. RURUPADA DAS	HARISAGAR PAR	GENERAL	NO	M	832891577417	8371867430	
14	10	SC 028 HARISAGARP AR	SNIGDHA SAHA	KALIDAS SAHA	HARISAGAR PAR	SC	NO	F	420771914612	7908559705	
15	10	SC 028 HARISAGARP AR	MALATI BITTER	JADU BITTER	HARISAGAR PAR	SC	NO	F	382776645772	8001032368	
16	10	SC 028 HARISAGARP AR	SANIAY DALUI	PRASANTA DALUI	HARISAGAR PAR	SC	NO	M	725353703419	6297353899	

CHAIRMAN
KANDI MUNICIPALITY

PMAY (HFA- 2019-20)







BENEFICIARY LIST OF KANDI MUNICIPALITY

Sl. No.	Ward No	SLUM /Non Slum	Name of Beneficiary	Father's Name / Husband's Name	Holding No./Address	Category		Gender	Adhaar No.	Mob No.	Photo
						General/S.C./O.B. C./S.T.	Minority				
1	10	SC 051 BAGDIPARA JELOPARA	UNNATI KAIBARTYA	LT. BABLU KAIBARTYA	RUPPUR JELOPARA	SC	NO	F	655365193517	6295359545	
2	10	SC 051 BAGDIPARA JELOPARA	SANJIB KAIBARTYA	SUBAL KAIBARTYA	RUPPUR JELOPARA	SC	NO	M	520335065108	6297160145	
3	10	SC 051 BAGDIPARA JELOPARA	GAYANATH KAIBARTYA	LT. KHOKAN KAIBARTYA	RUPPUR JELOPARA	SC	NO	M	683371563948	8436639271	
4	10	SC 051 BAGDIPARA JELOPARA	HEMANTA KUMAR DAS	LT. MADHUSUDAN DAS	RUPPUR JELOPARA	SC	NO	M	673736354810	9733072061	







CHAIRMAN
KANDI MUNICIPALITY

PMAY (HFA- 2019-20)

BENEFICIARY LIST OF KANDI MUNICIPALITY

Sl. No.	Ward No	SLUM /Non Slum	Name of Beneficiary	Father's Name / Husband's Name	Holding No./Address	Category		Gender	Adhaar No.	Mob No.	Photo
						General/S.C./O.B.C./S.T	Minority				
1	10	SC-052 GOURTALA BANISANGHA GROUND	BASUDEB PAL	LT. DAMAN GOPAL PAL	DHALLAPARA	OBC	NO	M	429469813645	8145290857	
2	10	SC-052 GOURTALA BANISANGHA GROUND	ANANDA GOPAL DAS	LT. GANGA DHAR DAS	MOLLAPARA	GENERAL	NO	M	474461878123	7047618840	
3	10	SC-052 GOURTALA BANISANGHA GROUND	SAMIR DAS	LT. NANDA DULAL DAS	MOLLAPARA	GENERAL	NO	M	217497227352	7001273379	
4	10	SC-052 GOURTALA BANISANGHA GROUND	TAPASI MUKHERJEE	MANIMOY MUKHERJEE	DHALLAPARA	GENERAL	NO	F	791374252566	9735532938	
5	10	SC-052 GOURTALA BANISANGHA GROUND	KRISHNA KANAI MONDAL	BAMACHARAN MONDAL	MOLLAPARA	GENERAL	NO	M	634840436898	9609045925	
6	10	SC-052 GOURTALA BANISANGHA GROUND	RAJU DAS	BINAYBHUSAN DAS	MOLLAPARA	OBC	NO	M	414874886772	9775413774	
7	10	SC-052 GOURTALA BANISANGHA GROUND	SANJIB CHOWDHURY	LT. PURNACHANDRA CHOWDHURY	MOLLAPARA	SC	NO	M	883071221848	9775219562	
8	10	SC-052 GOURTALA BANISANGHA GROUND	TAPAN KONAI	SANTANA KONAI	DHALLAPARA	SC	NO	M	479737576549	8617864728	
9	10	SC-052 GOURTALA BANISANGHA GROUND	SANTOSH KUMAR DAS	JIBAN KUMAR DAS	DHALLAPARA	SC	NO	M	621325329292	9153096174	









CHAIRMAN
KANDI MUNICIPALITY

Sl. No.	Ward No	SLUM /Non Slum	Name of Beneficiary	Father's Name / Husband's Name	Holding No./Address	Category		Gender	Adhaar No.	Mob No.	Photo
						General/S.C./O.B.C./S.T	Minority				
10	10	SC 052 GOURTALA BANISANGHA GROUND	TUHIN CHATTORAU	MRINALKANTI CHATTORAU	DHALLAPARA	GENERAL	NO	M	263093675355	7699048436	
11	10	SC 052 GOURTALA BANISANGHA GROUND	SAMIT KUMAR CHOUDHURY	LAKHAN CHOUDHURY	MOLLAPARA	SC	NO	M	972833279560	9047553691	
12	10	SC 052 GOURTALA BANISANGHA GROUND	RAJENDRA KUMAR PAL	LT. SAKTI SANKAR PAL	DHALLAPARA	O.B.C	NO	M	670341699588	9832298136	
13	10	SC 052 GOURTALA BANISANGHA GROUND	MALATI DAS	LT. RASMOHAN DAS	MOLLAPARA	GENERAL	NO	F	909678962612	9091909433	
14	10	SC 052 GOURTALA BANISANGHA GROUND	ANNAPURNA KUNDU	LT. HARADHAN KUNDU	MOLLAPARA	GENERAL	NO	F	780609399941	6234521729	
15	10	SC 027 HAELIPARA	SANJAY KAIBARTTA	NAKUL KAIBARTTA	RUPPUR HABILIPAR	SC	NO	M	679412672919	8167870998	











CHAIRMAN
KANDI MUNICIPALITY





PMAY (HFA- 2019-20)

BENEFICIARY LIST OF KANDI MUNICIPALITY

Sl. No.	Ward No	SLUM/ NON SLUM	Name of Beneficiary	Father's Name / Husband's Name	Holding No./Address	Category		Gender	Adhaar No.	Mob No.	Photo
						General/S.C./O.B. C./S.T	Minority				
1	11	SHIBRAMBATI SC 029	ANITA BAGDI	KAILASH BAGDI (MAJHI)	345/1 SHIBRAMBARI	SC	NO	F	205644326923	9733697162	
2	11	SHIBRAMBATI SC 029	AMAR GHOSH	TILOK GHOSH	244/2 SHIBRAMBARI	OBC	NO	M	895545435620	9800081706	
3	11	SHIBRAMBATI SC 029	SIKHA DAS	SADHAN KUMAR GHOSH	103/215/1 SHIBRAMBARI	SC	NO	F	280060867667	7063134070	
4	11	SHIBRAMBATI SC 029	SANJIT SAHA	HEMANTA KUMAR SAHA	232/359/1 SHIBRAMBARI	SC	NO	M	458828309597	9334646787	
5	11	SHIBRAMBATI SC 029	ARCHANA DAS	SAMIRAN DAS	79/266/391/1 SHIBRAMBARI	SC	NO	F	779895953904	9732420613	
6	11	SHIBRAMBATI SC 029	SIMA DAS	DILIP DAS	286/A SHIBRAMBARI	SC	NO	F	780860270782	9593122824	
7	11	SHIBRAMBATI SC 029	BASANTI DAS	NITAI DAS	253/376 SHIBRAMBARI	SC	NO	F	727732892870	9126712166	
8	11	SHIBRAMBATI SC 029	BISWAJIT SAHA	HEMANTA KUMAR SAHA	37/40/1 SHIBRAMBARI	SC	NO	M	954218068541	8670011844	
9	11	SHIBRAMBATI SC 029	BIRENDRA DAS	DHIREN DAS	69/80/A SHIBRAMBARI	SC	NO	M	226821252824	7585007774	

CHAIRMAN
 KANDI MUNICIPALITY









Sl. No.	Ward No	SLUM/ NON SLUM	Name of Beneficiary	Father's Name / Husband's Name	Holding No./Address	Category		Gender	Adhaar No.	Mob No.	Photo
						General/S.C./O.B. C./S.T	Minority				
10	11	SHIBRAMBATI SC 029	MOUSUMI DAS	SHASTI CHARAN DAS	95/257 SHIBRAMBARI	SC	NO	F	488656587889	9735276288	
11	11	SHIBRAMBATI SC 029	CHANDAN DAS	SANTI DAS	96/C/69 SHIBRAMBARI	SC	NO	M	36817853676	9564210852	
12	11	SHIBRAMBATI SC 029	BAPI DAS	MANMOTHO DAS	92/D SHIBRAMBARI	SC	NO	M	748123092036	9064210852	
13	11	SHIBRAMBATI SC 029	SHUBRA DAS	JITEN DAS	252/375/1 SHIBRAMBARI	SC	NO	F	979031664227	9635429764	
14	11	SHIBRAMBATI SC 029	SHIKHA DAS	LT DHANAPATI DAS	317/2 SHIBRAMBARI	SC	NO	F	779480816719	9064572807	
15	11	SHIBRAMBATI SC 029	HARAGOURI DAS	LT BHAAHARI DAS	319/B SHIBRAMBARI	SC	NO	F	854973401996	7872422909	
16	11	SHIBRAMBATI SC 029	MIRA DAS	PESAR DAS	57/240/1 SHIBRAMBARI	SC	NO	F	823500237188	7478333855	
17	11	SHIBRAMBATI SC 029	JHANTU DAS	LT UMAPADA DAS	63/231/2 SHIBRAMBARI	SC	NO	M	633004451350	9800440371	
18	11	SHIBRAMBATI SC 029	SUMITA DAS	UTPAL DAS	248/1 SHIBRAMBARI	SC	NO	F	789324346072	8670718293	
19	11	SHIBRAMBATI SC 029	APAN DAS	LT DHARANI DAS	403/A SHIBRAMBARI	SC	NO	M	762798320114	8016841702	











Sl. No.	Ward No	SLUM/ NON SLUM	Name of Beneficiary	Father's Name / Husband's Name	Holding No./Address	Category		Gender	Adhaar No.	Mob No.	Photo
						General/S.C./O.B. C./S.T	Minority				
20	11	SHIBRAMBATI SC 029	ASHA DAS	ASHIM DAS	223/B SHIBRAMBARI	SC	NO	F	730771770358	8371948285	
21	11	SHIBRAMBATI SC 029	NAMITA DAS	CHHOTON DAS	51/215/1 SHIBRAMBARI	SC	NO	F	786438927045	6294228963	
22	11	SHIBRAMBATI SC 029	SURESH DAS	KINKAR DAS	534/1 SHIBRAMBARI	SC	NO	M	592493148226	9732897077	
23	11	SHIBRAMBATI SC 029	PRAKASH DAS	SHANTU DAS	21/19/1 SHIBRAMBARI	SC	NO	M	911188677979	9851587581	
24	11	SHIBRAMBATI SC 029	SANJOY DAS	L.T. NIMAI DAS	246/369, SHIBARAMBATI	SC	NO	M	505572997776	7872478818	

CHAIRMAN
KANDI MUNICIPALITY





PMAY (HFA- 2019-20)

BENEFICIARY LIST OF KANDI MUNICIPALITY

Sl. No.	Ward No	SLUM /Non Slum	Name of Beneficiary	Father's Name / Husband's Name	Holding No./Address	Category		Gender	Adhaar No.	Mob No.	Photo
						General/S.C./O.B. C./S.T	Minority				
1	11	BIJOYNAGAR TALARPAR SC 030	TAPAS DAS	SADHAN DAS	61/153/160 BIJOYNAGAR TALAR PAR	SC	NO	M	203293091841	9733805552	
2	11	BIJOYNAGAR TALARPAR SC 030	BAPI DAS	RENUPADA DAS	57/122/123/1 BIJOYNAGAR TALAR PAR	SC	NO	M	201016528585	7407966494	
3	11	BIJOYNAGAR TALARPAR SC 030	MIRA GHATAK	PRADIP KUMAR GHATAK	32/216/1 BIJOYNAGAR TALAR PAR	GEN	NO	F	865896144540	8617627401	
4	11	BIJOYNAGAR TALARPAR SC 030	MADHAB GHOSH	NIBARAN GHOSH	300/B BIJOYNAGAR TALAR PAR	GEN	NO	M	929868993976	8617056460	
5	11	BIJOYNAGAR TALARPAR SC 030	KASHI NATH PAL	KISHORI MOHON PAL	86/1 BIJOYNAGAR TALAR PAR	GEN	NO	M	640510196764	8926053819	
6	11	BIJOYNAGAR TALARPAR SC 030	SAMBHU DAS	LT BAIDYANATH DAS	137/139/1 BIJOYNAGAR TALAR PAR	SC	NO	M	709284442693	8668726844	
7	11	BIJOYNAGAR TALARPAR SC 030	CHAINA KAR	BABLU KAR	123/124/1 BIJOYNAGAR TALAR PAR	GEN	NO	F	756817121950	9593044025	
8	11	BIJOYNAGAR TALARPAR SC 030	SARASWATI DAS	LT ANANDA DAS	164/150 BIJOYNAGAR TALAR PAR	SC	NO	F	801922865135	9733575665	
9	11	BIJOYNAGAR TALARPAR SC 030	BAIKUNTHA DAS	KANAI DAS	126/1 BIJOYNAGAR TALAR PAR	SC	NO	M	414626901811	5159077663	

10	11	BIJOYNAGAR TALARPAR SC 030	PRASANTA DAS	LT MADAN MOHON DAS	135/137 BIJOYNAGAR TALAR PAR	SC	NO	M	469588939649	9333949186	
11	11	BIJOYNAGAR TALARPAR SC 030	DOLJI HAZRA	LT GOBINDA HAZRA	99/C BIJOYNAGAR TALAR PAR	SC	NO	F	999764842686	8145253157	
12	11	BIJOYNAGAR TALARPAR SC 030	UTPAL DAS	CHINMOY DAS	230/A BIJOYNAGAR TALAR PAR	SC	NO	M	660333792808	7479112471	
13	11	BIJOYNAGAR TALARPAR SC 030	URMILA DAS	JAYANTA KUMAR DAS	49/6/203 BIJOYNAGAR TALAR PAR	GEN	NO	F	392960433437	8337836006	
14	11	BIJOYNAGAR TALARPAR SC 030	GOURANGA DAS	DILIP DAS	328/307/2 BIJOYNAGAR TALAR PAR	GEN	NO	M	619796950417	7908246673	
15	11	BIJOYNAGAR TALARPAR SC 030	SHYAMSUNDAR DAS	KANAI CHANDRA DAS	31/D/116 BIJOYNAGAR TALAR PAR	GEN	NO	M	727823742627	8670544230	
16	11	BIJOYNAGAR TALARPAR SC 030	KALICHARAN DAS	LT DILIP DAS	129/131/2 BIJOYNAGAR TALAR PAR	SC	NO	M	840953486646	9735359219	
17	11	BIJOYNAGAR TALARPAR SC 030	HRIDYA KAMIAL DAS	KESHAB CHANDRA DAS	N 32 BIJOYNAGAR TALAR PAR	SC	NO	M	270707409379	8016377460	
18	11	BIJOYNAGAR TALARPAR SC 030	CHAITALI GHATAK PANDAY	PALLAB KUMAR GHATAK	211/C BIJOYNAGAR TALAR PAR	GEN	NO	F	253036062366	9475738749	
19	11	BIJOYNAGAR TALARPAR SC 030	PRAKASH CHANDRA BHAKTA	LT PATITPABAN BHAKTA	416/A BIJOYNAGAR TALAR PAR	SC	NO	M	803754056549	9795878894	
20	11	BIJOYNAGAR TALARPAR SC 030	SWAPAN DUTTA	LT ABANI DUTTA	84/11/C BIJOYNAGAR TALAR PAR	GEN	NO	M	829446242854	7407305442	











CHAIRMAN
KANDI MUNICIPALITY

21	11	BIJOYNAGAR TALARPAR SC 030	TATAN KUMAR DAS	SHANTI GOPAL DAS	13/1 BIJOYNAGAR TALAR PAR	GEN	NO	M	277981812137	9775491318	
22	11	BIJOYNAGAR TALARPAR SC 030	JOYTI DAS	SWAPAN DAS	79/A/207/4 BIJOYNAGAR TALAR PAR	GEN	NO	M	787492329568	8372024880	
23	11	BIJOYNAGAR TALARPAR SC 030	SUSMITA DUTTA	SAGAR KUMAR DUTTA	317/A BIJOYNAGAR TALAR PAR	GEN	NO	F	374114313696	9635118915	
24	11	BIJOYNAGAR TALARPAR SC 030	TARUN DAS	MUKTI DAS	137/A, BIJOYNAGAR	SC	NO	M	785486462509	9635105812	







 CHAIRMAN
 KANDI MUNICIPALITY

P MAY (HFA- 2019-20)

BENEFICIARY LIST OF KANDI MUNICIPALITY

Sl. No.	Ward No	SLUM /Non Slum	Name of Beneficiary	Father's Name / Husband's Name	Holding No./Address	Category		Gender	Adhaar No.	Mob No.	Photo
						General/S.C./O.B. C./S.T	Minority				
1	11	HOTELPARA SC 053	MONOHARA BIBI	KADAR ALI	316/03/420 KANDI HOTELPARA	GENERAL	YES	F	334418055731	8145339044	
2	11	HOTELPARA SC 053	KULSON BIBI	SAMU SK	354/504/01 KANDI HOTELPARA	GENERAL	YES	F	772205339556	7363058311	
3	11	HOTELPARA SC 053	HAMELA KHATUN	AMIN SK	510/1KANDI HOTELPARA	GENERAL	YES	F	767522391180	7797655441	
4	11	HOTELPARA SC 053	AFROJA BIBI	JAFAR SEKH	419/2 KANDI HOTELPARA	GENERAL	YES	F	520548847246	9609778012	
5	11	HOTELPARA SC 053	CHAINA KHATUN	SAFIKUL SK	216/B KANDI HOTELPARA	GENERAL	YES	F	201092957424	8967593636	
6	11	HOTELPARA SC 053	RUNI BEGUM	SALEK HOSSAIN	509/A KANDI HOTELPARA	GENERAL	YES	F	554212250818	8768201970	
7	11	HOTELPARA SC 053	NURJAHAN BIBI	MOJIBAR RAHAMAN	536/1 KANDI HOTELPARA	GENERAL	YES	F	861817026264	7407707462	
8	11	HOTELPARA SC 053	OHEBA BIBI	LT NUR ALI SK	505/3 KANDI HOTELPARA	GENERAL	YES	F	545267243131	90641022873	
9	11	HOTELPARA SC 053	AMITAJ SK	MALDAR SK	365/1 KANDI HOTELPARA	GENERAL	YES	M	414420207791	7001147143	

CHAIRMAN
KANDI MUNICIPALITY

Sl. No.	Ward No	SLUM /Non Slum	Name of Beneficiary	Father's Name / Husband's Name	Holding No./Address	Category		Gender	Adhaar No.	Mob No.	Photo
						General/S.C./O.B. C./S.T	Minority				
10	11	HOTELPARA SC 053	MOUSUMI BIBI	LAL MIA	89/99/1 KANDI HOTELPARA	GENERAL	YES	F	718657175494	9653215955	
11	11	HOTELPARA SC 053	NURJAHAN BIBI	REHEL SK	222/A KANDI HOTELPARA	GENERAL	YES	F	787925869465	7908116957	
12	11	HOTELPARA SC 053	PIYARI BIBI	DULAL SK	213/1 KANDI HOTELPARA	GENERAL	YES	F	561382825907	9635873458	
13	11	HOTELPARA SC 053	MERINA BIBI	PINTU SK	390/F KANDI HOTELPARA	GENERAL	YES	F	321275580879	8327554646	
14	11	HOTELPARA SC 053	MANOWARA BIBI	INSAN SK	341/A KANDI HOTELPARA	GENERAL	YES	F	949289851708	9535396982	
15	11	HOTELPARA SC 053	ASMAUL SEIKH	FAKIR SK	317/D KANDI HOTELPARA	GENERAL	YES	M	976720613811	9609239788	
16	11	HOTELPARA SC 053	CHAMANARA BEGUM	ALI JAFAR MIA	319/D KANDI HOTELPARA	GENERAL	YES	F	754963400828	9434336622	

CHAIRMAN
KANDI MUNICIPALITY

PMAY (HFA- 2019-20)









BENEFICIARY LIST OF KANDI MUNICIPALITY

Sl. No.	Ward No	SLUM /Non Slum	Name of Beneficiary	Father's Name / Husband's Name	Holding No./Address	Category		Gender	Adhaar No.	Mob No.
						General/S.C./O.B. C./S.T	Minority			
1	11	CHANDALPAR A SC 054	MADHAB CHANDRA HALDER	CHANDI CHARAN HALDER	47/45/329/473 CHANDALPARA	General/S.C./O.B.C./ S.T	NO	M	332991638330	9732750143
2	11	CHANDALPAR A SC 054	SHANTI DAS	LT CHANDGOOPAL DAS	47/330/474 CHANDALPARA	SC	NO	M	694698962720	75860871568
3	11	CHANDALPAR A SC 054	PURNA CHANDRA DAS	LT SANATAN DAS	349/D CHANDALPARA	SC	NO	M	812431340045	9932776014
4	11	CHANDALPAR A SC 054	SOMNATH ROY	LT DEBNATH ROY	468/1 CHANDALPARA	GEN	NO	M	692617931375	9474708316
5	11	CHANDALPAR A SC 054	TARUN KUMAR DAS	LT ANANDA GOPAL DAS	68/C/1 CHANDALPARA	SC	NO	M	841875904008	6768582797
6	11	CHANDALPAR A SC 054	RAMESH CHANDRA DAS	KARTICK CHANDRA DAS	53/03/03 SHIBRAMBATI	SC	NO	M	683976617053	7001103553



CHAIRMAN
KANDI MUNICIPALITY

PMAY (HFA- 2019-20)

BENEFICIARY LIST OF KANDI MUNICIPALITY

Sl. No.	Ward No	SLUM / Non Slum	Name of Beneficiary	Father's Name / Husband's Name	Holding No./Address	Category		Gender	Adhaar No.	Mob No.	Photo
						General/S.C./O.B. C./S.T	Minority				
1	11	MONGALPARA SC 055	BISHNU DAS	MIHIR DAS	199/1 SHIBRAMBATI	SC	NO	M	777323733563	740796313	
2	11	MONGALPARA SC 055	SUDHIR DAS	LT HARADHAN DAS	103/218/3 SHIBRAMBATI	SC	NO	M	518952569610	9126292973	
3	11	MONGALPARA SC 055	SUKHEN DAS	LT NITAI DAS	322/1 SHIBRAMBATI	SC	NO	M	800286424560	7384385483	
4	11	MONGALPARA SC 055	KARTIK DAS	LT RUDREDEB DAS	109/211/1 SHIBRAMBATI	SC	NO	M	436820804086	9775330068	
5	11	MONGALPARA SC 055	RABI DAS	LT UDAY DAS	88/A SHIBRAMBATI	SC	NO	M	391721050723	9331995288	
6	11	MONGALPARA SC 055	ASHOKE DAS	LT SURYA DAS	315/1 SHIBRAMBATI	SC	NO	M	642701683834	8348331754	
7	11	MONGALPARA SC 055	BISWANATH DAS	TAPAN DAS	102/119 SHIBRAMBATI	SC	NO	M	913175893398	8348825766	
8	11	MONGALPARA SC 055	GADAI DAS	LT TENUPADA DAS	224/339 SHIBRAMBATI	SC	NO	M	312358279698	9682680469	
9	11	MONGALPARA SC 055	TAPAN DAS	LT KARTIK DAS	62/D SHIBRAMBATI	SC	NO	M	236736536054	6296016754	

CHAIRMAN
KANDI MUNICIPALITY

Sl. No.	Ward No	SLUM /Non Slum	Name of Beneficiary	Father's Name / Husband's Name	Holding No./Address	Category		Gender	Adhaar No.	Mob No.	Photo
						General/S.C./O.B. C./S.T	Minority				
10	11	MONIGALPARA SC 055	GOUR PRADHAN	GAIJ PRADHAN	N 328/1 SHIBRAMBATI	SC	NO	M	265252909038	8670568920	
11	11	MONIGALPARA SC 055	PRAVAT KUMAR DAS	LT SUDHIR KUMAR DAS	79/C/120 SHIBRAMBATI	SC	NO	M	497642254371	9635529532	

CHAIRMAN
KANDI MUNICIPALITY

PMAY (HFA- 2019-20)







BENEFICIARY LIST OF KANDI MUNICIPALITY

Sl. No.	Ward No	SLUM /Non Slum	Name of Beneficiary	Father's Name / Husband's Name	Holding No./Address	Category		Gender	Adhaar No.	Mob No.	Photo
						General/S.C./O.B.C./S.T	Minority				
1		GHURUPARA	RABI PAL	RENUPADA PAL	BISWASPARA, BAGDANGA	O B C	NO	M	805060936362		
2	12	GHURUPARA	SERIBANU BIBI	MANIRUL SK	NAMU BAGDANGA	GENERAL	YES	M	722603745369	8967891205	
3	12	GHURUPARA	ABOL SK	ENCHHAB SK	NAMU BAGDANGA	GENERAL	YES	M	806278712388	9749253889	
4	12	GHURUPARA	DALI BIBI	HABAL SK	BISWASPARA, BAGDANGA	GENERAL	YES	F	831560000377 3	9992078472	
5	12	GHURUPARA	HANIF SK	ABU BAKKAR SK	BISWASPARA, BAGDANGA	GENERAL	YES	M	286910436962	6295633671	
6	12	GHURUPARA	AJMAT SK	AKTAR SK	BISWASPARA, BAGDANGA	GENERAL	YES	M	649553923728		
7	12	GHURUPARA	PROVAT GHOSH	KARTICK GHOSH	GHUROPARA	O B C	NO	M	596421688057		

CHAIRMAN
KANDI MUNICIPALITY

PMAY (HFA- 2019-20)







BENEFICIARY LIST OF KANDI MUNICIPALITY

Sl. No.	Ward No	SLUM /Non Slum	Name of Beneficiary	Father's Name / Husband's Name	Holding No./Address	Category		Gender	Adhaar No.	Mob No.	Photo
						General/S.C./O.B. C./S.T	Minority				
1	12	JAKHADANGA NORTH	MURSEDA BIBI	RAJAN SK.	BISWASPARA, BAGDANGA	GENERAL	Minority	F	466178180194	9547180455	
2	12	JAKHADANGA NORTH	RUNGELA BIBI	RABIUL SK.	JAKHADANGA, BAGDANGA	GENERAL	Minority	F	453227163133	8918056237	
3	12	JAKHADANGA NORTH	KAMAL SK.	LT. MUJIBAR RAHAMAN	JAKHADANGA, BAGDANGA	GENERAL	Minority	M	526576366545	9564768348	
4	12	JAKHADANGA NORTH	AHADALI SK.	SHERALI SK.	JAKHADANGA, BAGDANGA	GENERAL	Minority	M	341904209070		
5	12	JAKHADANGA NORTH	LALCHAND SK.	CHAMATKAR SK.	JAKHADANGA, BAGDANGA	GENERAL	Minority	M			
6	12	JAKHADANGA NORTH	ASMANTARA BIBI	RAMESH SK.	JAKHADANGA, BAGDANGA	GENERAL	Minority	F	284583931603		
7	12	JAKHADANGA NORTH	ABU SAIKH	ABU BAKKAR	JAKHADANGA, BAGDANGA	GENERAL	Minority	M	983125540003 4		

CHAIRMAN
KANDI MUNICIPALITY

PMAY (HFA- 2019-20)

BENEFICIARY LIST OF KANDI MUNICIPALITY

Sl. No.	Ward No	SLUM /Non Slum	Name of Beneficiary	Father's Name / Husband's Name	Holding No./Address	Category		Gender	Adhaar No.	Mob No.	Photo
						General/S.C./O.B. C./S.T	Minority				
1	12	JAKHADANGA SOUTH	APARNA PAL	LT. ODAM CHANDRA PAL	BISWASPARA, BAGDANGA	O B C	Minority	F	991716641015	9362937224	
2	12	JAKHADANGA SOUTH	HANIF SK.	LT. BARI SK.	JAKHADANGA, BAGDANGA	GENERAL	Minority	M	564770840129	8101461197	
3	12	JAKHADANGA SOUTH	SAREJA BIBI	LT. JIRAT SK.	JAKHADANGA, BAGDANGA	GENERAL	Minority	F	443855502094	8101461197	
4	12	JAKHADANGA SOUTH	BADAM SK.	LT. ARSAD SK.	JAKHADANGA, BAGDANGA	GENERAL	Minority	M	867076136792		
5	12	JAKHADANGA SOUTH	PIYARUN BIBI	RAHAMAT/ RAHAM SK.	JAKHADANGA, BAGDANGA	GENERAL	Minority	F	363397470010		
6	12	JAKHADANGA SOUTH	KHALEDA BIBI	BAKTAR SK.	JAKHADANGA, BAGDANGA	GENERAL	Minority	F	637811007496		
7	12	JAKHADANGA SOUTH	HASMAT SK.	FULCHAND SK.	JAKHADANGA, BAGDANGA	GENERAL	Minority	M	377000104674		

 CHAIRMAN
 KANDI MUNICIPALITY

PMAY (HFA - 2019-20)







BENEFICIARY LIST OF KANDI MUNICIPALITY

Sl. No.	Ward No	SLUM /Non Slum	Name of Beneficiary	Father's Name / Husband's Name	Holding No./Address	Category		Gender	Adhaar No.	Mob No.	Photo
						General/S.C./O.B. C./S.T	Minority				
1	12	NAMUBAGDA NGA WEST	MANSUR SK.	RAKHU SK.	RAMSAGARPAR, BAGDANGA	GENERAL	Minority	M	620625847684	8178445735	
2	12	NAMUBAGDA NGA WEST	HANIF SK.	SHUKUR SK.	RAMSAGARPAR, BAGDANGA	GENERAL	Minority	M	444104463413	9647060925	
3	12	NAMUBAGDA NGA WEST	SUKCHAND SK.	AMIR SK.	BISWASPARA, BAGDANGA	GENERAL	Minority	M	647998896558	9547180455	
4	12	NAMUBAGDA NGA WEST	MAHIK SK.	TAHID SK.	NAMUBAGDANGA	GENERAL	Minority	M	915688947153	7029734146	
5	12	NAMUBAGDA NGA WEST	SANTIBROTO SINHA	KUMUDESH CHANDRA SINHA	NAMUBAGDANGA	GENERAL	NO	M	927820058869	7872288272	
6		JAKHADANGA SOUTH	AROBI BIBI	AKBOR SK.	BISWASPARA, BAGDANGA	GENERAL	Minority	F	720924488635		
7		JAKHADANGA SOUTH	ABEDA BIBI	JANU SK.	BISWASPARA, BAGDANGA	GENERAL	Minority	F	352311426759		

CHAIRMAN
KANDI MUNICIPALITY

PMAY (HFA- 2019-20)









BENEFICIARY LIST OF KANDI MUNICIPALITY

Sl. No.	Ward No	SLUM / Non Slum	Name of Beneficiary	Father's Name / Husband's Name	Holding No./Address	Category		Gender	Adhaar No.	Mob No.	Photo
						General/S.C./O.B.C./S.T	Minority				
1	12	JAKHADJANGA SOUTH	RAFIK SK.	NAJEM SK.	BISWASPARA, BAGDANGA	GENERAL	Minority	M	713777931500		
2	12	NAMUBAGD ANGA EAST	SANTANA HAZRA	JOYGOPAL HAZRA	BAGDANGA	SC	NO	F	356677364474		
3	12	NAMUBAGD ANGA EAST	SANJOY BISWAS	NITYANANDA BISWAS	BAGDANGA	OBC	NO	M	827814608875		
4	12	NAMUBAGD ANGA EAST	JELI BIBI	JAKER HOSSAIN	NAMUBAGDANGA	GENERAL	Minority	F			
5	12	NAMUBAGD ANGA EAST	MAGERA BIBI	PATAL SK.	NAMUBAGDANGA	GENERAL	Minority	F	916590496625		
6	12	NAMUBAGD ANGA EAST	ASHARUL SEKH	WASIM SEKH	NAMUBAGDANGA	GENERAL	Minority	M	390215832571		
7	12	NAMUBAGD ANGA EAST	KAJEM SK	MAJID SK	NAMUBAGDANGA	GENERAL	Minority	M	341090461750		









 CHAIRMAN
 KANDI MUNICIPALITY

PMAY (HFA- 2019-20)

BENEFICIARY LIST OF KANDI MUNICIPALITY

Sl. No.	Ward No	SLUM /Non Slum	Name of Beneficiary	Father's Name / Husband's Name	Holding No./Address	Category		Gender	Adhaar No.	Mob No.	Photo
						General/S.C./O.B. C./S.T	Minority				
1	13	NAMUBAGDA NGA (034)	MANIKA HAJRA	SADHU HAZRA	17/NEW/A, BAGDANGA	S C		F	254588531674	9733613347	
2	13	NAMUBAGDA NGA (034)	LOHARAM HAZRA	BISWANATH HAZRA	336/NEW, BAGDANGA	S C		M	335786436045	9679191089	
3	13	NAMUBAGDA NGA (034)	SHRABANI BAGDI	LALA BAGDI	36/NEW, BAGDANGA	S C		F	776054233728	7797337956	
4	13	NAMUBAGDA NGA (034)	DAYAL BAGDI	SHYAMA BAGDI	58/1/A, BAGDANGA	S C		M	464641845014	7872670946	
5	13	NAMUBAGDA NGA (034)	MILAN BAGDI	NARAYAN BAGDI	11/1/B, BAGDANGA	S C		M	786935260972	7872670945	
6	13	NAMUBAGDA NGA (034)	SHRIDHAR BAGDI	SHAKTI BAGDI	29/NEW, BAGDANGA	S C		M	376404667040	6297128505	
7	13	NAMUBAGDA NGA (034)	PATHARI BIBI	UMMAT SEKH	128/A, BAGDANGA	GENERAL	Minority	F	835801304666	6297387591	
8	13	NAMUBAGDA NGA (034)	MONIRUDDIN SK.	KUDDUS SK.	65/NEW, BAGDANGA	GENERAL	Minority	M	515623560871	7797313213	





CHAIRMAN
KANDI MUNICIPALITY

Sl. No.	Ward No	SLUM /Non Slum	Name of Beneficiary	Father's Name / Husband's Name	Holding No./Address	Category		Gender	Adhaar No.	Mob No.	Photo
						General/S.C./O.B. C./S.T	Minority				
9	13	NAMUBAGDA NGA (034)	RAJIL SK.	RAFEN SK.	23/18/A, BAGDANGA	GENERAL	Minority	M	501474513307	9734223010	
10	13	NAMUBAGDA NGA (034)	HILAL SEKH	RAFEN SEKH	106/NEW, BAGDANGA	GENERAL	Minority	M	218364424805	8176024450	
11	13	NAMUBAGDA NGA (034)	SABER ALI	MIANJAN SEKH	12/NEW, BAGDANGA	GENERAL	Minority	M	897943916863	8436635046	
12	13	NAMUBAGDA NGA (034)	MAJIBAR SEIKH	DILSAD SEIKH	13/NEW, BAGDANGA	GENERAL	Minority	M	853920832043	8436635045	
13	13	NAMUBAGDA NGA (034)	BASUDEB MONDAL	SHIBRAM MONDAL	127/NEW, BAGDANGA	GENERAL	NO	M	671581280519	9732144138	
14	13	NAMUBAGDA NGA (034)	KASHEM SEIKH	NURSED SEIKH	129/C, BAGDANGA	GENERAL	Minority	M	393447638562	9734532208	
15	13	NAMUBAGDA NGA (034)	JAMAL SK.	SATTAR SK.	34/NEW, NOWAPARA	GENERAL	Minority	M	465642537091	9609207801	











CHAIRMAN
KANDI MUNICIPALITY

PMAY (HFA- 2019-20)









BENEFICIARY LIST OF KANDI MUNICIPALITY

Sl. No.	Ward No	SLUM /Non Slum	Name of Beneficiary	Father's Name / Husband's Name	Holding No./Address	Category		Gender	Adhaar No.	Mob No.	Photo
						General/S.C./O.B. C./S.T	Minority				
1	13	NOWAPARA (035)	NIJAI SK.	KABER SK.	67/89/C, NOWAPARA	GENERAL	Minority	M	289316734425	7797188251	
2	13	NOWAPARA (035)	BENI KHATOON	NURAI SEKH	67/89/A, NOWAPARA	GENERAL	Minority	F	328847505007	8972260826	
3	13	NOWAPARA (035)	JANAI SK.	RAJAB ALI SK.	73/233, NOWAPARA	GENERAL	Minority	M	367642254285	8972260826	
4	13	NOWAPARA (035)	GOLBANU BEGAM	AKHER ALI	73/233, NOWAPARA	GENERAL	Minority	F	727772588310	7797188250	
5	13	NOWAPARA (035)	NEKBAS SEKH	IRFAN SEKH	108/K/180/A, NOWAPARA	GENERAL	Minority	M	727760890194	8081561719	
6	13	NOWAPARA (035)	SOUREFA BIBI	NUR MAHAMMAD SEKH	12/76/A, NOWAPARA	GENERAL	Minority	F	628638982788	8197328656	
7	13	NOWAPARA (035)	MAJEFOR SK.	UCHHAD SK.	36/NEW, NOWAPARA	GENERAL	Minority	M	863428611847	7793338056	
8	13	NOWAPARA (035)	KHOSERA BIBI	KIJAMAT SK.	81/216, NOWAPARA	GENERAL	Minority	F	551791664717	9734465606	









 CHAIRMAN
 KANDI MUNICIPALITY

Sl. No.	Ward No	SLUM /Non Slum	Name of Beneficiary	Father's Name / Husband's Name	Holding No./Address	Category		Gender	Adhaar No.	Mob No.	Photo
						General/S.C./O.B. C./S.T	Minority				
9	13	NOWAPARA (035)	SAHEDA BIBI	ABUL HOSSAIN SK.	24/NEW, NOWAPARA	GENERAL	Minority	F	833999444207	7620200983	
10	13	NOWAPARA (035)	SENEHAR BIBI	IBRAHIM KHALILLAH SK.	4/NEW, NOWAPARA	GENERAL	Minority	F	319892189735	834895154	
11	13	NOWAPARA (035)	RAJBA BIBI	CHAPATULLA	25/5/B, NOWAPARA	GENERAL	Minority	F	990248528958	9732606219	
12	13	NOWAPARA (035)	NASIMA BIBI	JABBAR SK.	50/NEW, NOWAPARA	GENERAL	Minority	F	371309558415	9734532207	
13	13	NOWAPARA (035)	NURJILA BIBI	SAHAJUDDIN SEKH	132/2/A, NOWAPARA	GENERAL	Minority	F	547502281282	9609207809	
14	13	NOWAPARA (035)	NASIR SEKH	KOBAD SEKH	133/130/B, NOWAPARA	GENERAL	Minority	M	816210801444	6294900872	
15	13	NOWAPARA (035)	MAKREB SEIKH	ASAR SEKH	18/62/C, NOWAPARA	GENERAL	Minority	M	784130248674	7797188251	
16	13	NOWAPARA (035)	MD. SHADEK SHAIKH	MD. INACHH SHAIKH	12/16/C, NOWAPARA	GENERAL	Minority	M	320282455121	9647447203	
17	13	NOWAPARA (035)	ISAD SK.	JARMAN SK.	70/1/C, NOWAPARA	GENERAL	Minority	M	654425480145	9732052315	



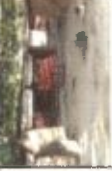





CHAIRMAN
KANDI MUNICIPALITY

Sl. No.	Ward No	SLUM /Non Slum	Name of Beneficiary	Father's Name / Husband's Name	Holding No./Address	Category		Gender	Adhaar No.	Mob No.	Photo
						General/S.C./O.B. C./S.T.	Minority				
18	13	NOWAPARA (035)	BEDANA BIBI	JULJAR SK.	92/A, NOWAPARA	GENERAL	Minority	F	628790656368	7001391743	
19	13	NOWAPARA (035)	RAFEJA BIBI	NUHU SEKH	96/A, NOWAPARA	GENERAL	Minority	F	886651795438	9734530022	
20	13	NOWAPARA (035)	RAJBANU BIBI	ASADUL SK.	160/A, NOWAPARA	GENERAL	Minority	F	304253262513	9609207809	
21	13	NOWAPARA (035)	TANJILA BIBI	DISHARAF ALI SK.	170/A, NOWAPARA	GENERAL	Minority	F	808405858950	62945550747	
22	13	NOWAPARA (035)	MD. ASJAD SK.	AJIMUDDIN SK.	76/1/A, NOWAPARA	GENERAL	Minority	M	306478739736	9647959319	
23	13	NOWAPARA (035)	JJARUL SEKH	INSHED SK.	761/NEW, NOWAPARA	GENERAL	Minority	M	734307691189	7602195170	
24	13	NOWAPARA (035)	SOHAGI BIBI	RASIK SEKH	110/NEW, NOWAPARA	GENERAL	Minority	F	307655359882	9734465007	
25	13	NOWAPARA (035)	KAFARUL SK.	RAKID SK.	216/NEW, NOWAPARA	GENERAL	Minority	M	735066119825	9064237344	
26	13	NOWAPARA (035)	RAMJAN SEIKH	ALI SEIKH	67/NEW, NOWAPARA	GENERAL	Minority	M	769326674787	8509745417	







CHAIRMAN
KANDI MUNICIPALITY

Sl. No.	Ward No	SLUM /Non Slum	Name of Beneficiary	Father's Name / Husband's Name	Holding No./Address	Category		Gender	Adhaar No.	Mob No.	Photo
						General/S.C./O.B.C./S.T	Minority				
27	13	NOWAPARA (035)	MAHARAN BIBI	CHHIRUDDIN SK.	70/NEW, NOWAPARA	GENERAL	Minority	F	590210086711	9064237344	
28	13	NOWAPARA (035)	ALOK SEKH	BABLU SEKH	65/ NEW, NOWAPARA	GENERAL	Minority	M	879484309234	6295800083	
29	13	NOWAPARA (035)	SAHAJAMAL SEIKH	SAHHOSSAIN	70/NEW, NOWAPARA	GENERAL	Minority	M	486114073443	8617580944	
30	13	NOWAPARA (035)	RAHIMUDDIN SK.	MATLEB SK.	93/NEW, NOWAPARA	GENERAL	Minority	M	763526887070	9382045685	
31	13	NOWAPARA (035)	CHHAMENA BIBI	ICHAB SK.	94/NEW, NOWAPARA	GENERAL	Minority	F	993313806911	6296746617	
32	13	NOWAPARA (035)	DEHEKA BIBI	BASAR SEKH	90/A, NOWAPARA	GENERAL	Minority	F	552867032847	9647525367	
33	13	NOWAPARA (035)	CHHABI BIBI	PACHKARI SK.	95/C, NOWAPARA	GENERAL	Minority	F	729109201047	8617580944	
34	13	NOWAPARA (035)	SELIM SEKH	LALU SEKH	90/NEW, NOWAPARA	GENERAL	Minority	M	837470046623	8101021108	
35	13	NOWAPARA (035)	ARJAN SEKH	TORAJ SK.	95/NEW, NOWAPARA	GENERAL	Minority	M	896304488145	9382095685	







CHAIRMAN
KANDI MUNICIPALITY

Sl. No.	Ward No	SLUM /Non Slum	Name of Beneficiary	Father's Name / Husband's Name	Holding No./Address	Category		Gender	Adhaar No.	Mob No.	Photo
						General/S.C./O.B. C./S.T	Minority				
36	13	NOWAPARA (035)	MANJAR SEKH	NOUSAD SEKH	104/NEW, NOWAPARA	GENERAL	Minority	M	251598476667	9609049064	
37	13	NOWAPARA (035)	CHHABED ALI	HAYAT SEKH	12/1/C, NOWAPARA	GENERAL	Minority	M	705249630532	629580083	
38	13	NOWAPARA (035)	HASEM SEKH	LACHRUDDIN SEKH	120/C, NOWAPARA	GENERAL	Minority	M	697019176715	8272335687	
39	13	NOWAPARA (035)	KHODABOX SEIKH	MOHID SEKH	128/C, NOWAPARA	GENERAL	Minority	M	875768578244	9734339870	
40	13	NOWAPARA (035)	HAMIJAR SK.	MECHHER SK.	29/B, NOWAPARA	GENERAL	Minority	M	225789796895	8182021108	
41	13	NOWAPARA (035)	BAHARUL SK.	RAJAU SK.	130/A, NOWAPARA	GENERAL	Minority	M	240321648216	9593860748	
42	13	NOWAPARA (035)	SAHIDUL SK.	NEWAJ ALI	138/A, NOWAPARA	GENERAL	Minority	M	820186317726	7872759378	
43	13	NOWAPARA (035)	TARAJ SEKH	HATEM SEKH	167/1, NOWAPARA	GENERAL	Minority	M	640263361131	9593860748	
44	13	NOWAPARA (035)	AROJA BIBI	DUKHU SK.	172/C, NOWAPARA	GENERAL	Minority	F	302435315089	6298429582	

 CHAIRMAN
 KANDI MUNICIPALITY

Sl. No.	Ward No	SLUM /Non Slum	Name of Beneficiary	Father's Name / Husband's Name	Holding No./Address	Category		Gender	Adhaar No.	Mob No.	Photo
						General/S.C./O.B. C./S.T	Minority				
45	13	NOWAPARA (035)	HAKSED KHAN	RANAI KHAN	230/C, NOWAPARA	GENERAL	Minority	M	840734283464	9732590613	
46	13	NOWAPARA (035)	HASIDUL KHAN	RAHAM KHAN	280/C, NOWAPARA	GENERAL	Minority	M	292828760848	9734532207	
47	13	NOWAPARA (035)	TAREFA BIBI	MAACHHEN SEIKH	192/A, NOWAPARA	GENERAL	Minority	F	272319147101	9734365840	
48	13	NOWAPARA (035)	ABU KHALEKH SK.	ABDUL JABBAR SK.	230/1, NOWAPARA	GENERAL	Minority	M	739670789289	9777355072	
49	13	NOWAPARA (035)	FAIN SK.	SAMSER SK.	230/C, NOWAPARA	GENERAL	Minority	M	465746345413	6297429582	
50	13	NOWAPARA (035)	AYAJ SEIKH	NIHAJ SEIKH	231/C, NOWAPARA	GENERAL	Minority	M	316665942853	9732606217	
51	13	NOWAPARA (035)	FAJAR SEIKH	PATHKURA SEIKH	160/C, NOWAPARA	GENERAL	Minority	M	469182096946	9564208904	
52	13	NOWAPARA (035)	ACHHAN SK.	NIMBARI SK.	170/C, NOWAPARA	GENERAL	Minority	M	689383132867	9732660112	
53	13	NOWAPARA (035)	ABDUL KERIM	CHANDARI SK.	179/A, NOWAPARA	GENERAL	Minority	M	734343926808	9564208901	









 CHAIRMAN
 KANDI MUNICIPALITY

Sl. No.	Ward No	SLUM /Non Slum	Name of Beneficiary	Father's Name / Husband's Name	Holding No./Address	Category		Gender	Adhaar No.	Mob No.	Photo
						General/S.C./O.B. C./S.T	Minority				
54	13	NOWAPARA (035)	AFAOYAJAN BIBI	ASMAR SK.	72/NEW, NOWAPARA	GENERAL	Minority	F	861077219764	7797188851	
55	13	NOWAPARA (035)	ALFAR ALI	FOROZ ALI	21/A, NOWAPARA	GENERAL	Minority	M	339152001576	8250467401	
56	13	NOWAPARA (035)	SAGERUN BIBI	NURUHAK SK.	65/NEW, NOWAPARA	GENERAL	Minority	F	381470541649	9593274823	
57	13	NOWAPARA (035)	BADIRUL SK.	NAZRUL SEKH	65/NEW, NOWAPARA	GENERAL	Minority	M	961258513996	9749500924	
58	13	NOWAPARA (035)	HAIDAR SEKH	MAHID SEKH	66/NEW, NOWAPARA	GENERAL	Minority	M	257549232464	9593494176	

 CHAIRMAN
 KANDI MUNICIPALITY









PMAY (HFA- 2019-20)

BENEFICIARY LIST OF KANDI MUNICIPALITY



Sl. No.	Ward No	SLUM /Non Slum	Name of Beneficiary	Father's Name / Husband's Name	Holding No./Address	Category		Gender	Adhaar No.	Mob No.	Photo
						General/S.C./O.B. C./S.T	Minority				
1	13	BOALIA (036)	NIMAI KONAI	BISWANATH KONAI	122/A, BOALIA	S.C.	NO	M	556620638452	8926623375	
2	13	BOALIA (036)	SHRIKANTA DAS	RAJKUMAR DAS	127/A, BOALIA	S.C.	NO	M	632111427776	8515041517	
3	13	BOALIA (036)	SWETBARAN DALUI	HARIPADA DALUI	121/NEW, BOALIA	S.C.	NO	M	424557036382	7797207477	
4	13	BOALIA (036)	LAILA KHATUN	ASRAFUL SK.	132/NEW, BOALIA	GENERAL	Minority	F	427483211207	7407853131	
5	13	BOALIA (036)	JAGANNATH DALUI	SHAKTIPADA DALUI	65/NEW, BOALIA	S.C.	NO	M	216080982642	7866946134	
6	13	BOALIA (036)	AKTUMA BIBI	RIHAI SEIKH	280/NEW, BOALIA	GENERAL	Minority	F	416326058756	7872503629	
7	13	BOALIA (036)	SAIYAD SAFIKUL ISLAM	SAIYAD NUR NABI	290/A, BOALIA	GENERAL	Minority	M	975827442668	7407184063	
8	13	BOALIA (036)	JAHANGIR KHAN	PATU KHAN	290/NEW, BOALIA	GENERAL	Minority	M	946900155363	7872503629	



CHAIRMAN
KANDI MUNICIPALITY

Sl. No.	Ward No	SLUM /Non Slum	Name of Beneficiary	Father's Name / Husband's Name	Holding No./Address	Category		Gender	Adhaar No.	Mob No.	Photo
						General/S.C./O.B. C./S.T	Minority				
9	13	BOALIA (036)	SABIR KHAN	MUKHTAR KHAN	123/NEW, BOALIA	GENERAL	Minority	M	460633679853	7872503629	
10	13	BOALIA (036)	ARSIA BIBI	GOLEMAN SK.	234/1, BOALIA	GENERAL	Minority	F	348766057291	9733704386	
11	13	BOALIA (036)	ANAR SK.	YEASIN SK.	250/1/1, BOALIA	GENERAL	Minority	M	412002879956	9641612115	
12	13	BOALIA (036)	NIZAM SK.	HAMID SK.	390/1/C, BOALIA	GENERAL	Minority	M	873639428903	9641612115	
13	13	BOALIA (036)	RUSTAM SK.	RAJAB ALI SK.	28/28/1, BOALIA	GENERAL	Minority	M	642130902006	9733764386	
14	13	BOALIA (036)	CHANDMAHAMMAD SK.	RAKID SK.	1280/NEW, BOALIA	GENERAL	Minority	M	297569739816	7797337950	
15	13	BOALIA (036)	RUMJAN SEKH	NAJIR SEKH	320/1, BOALIA	GENERAL	Minority	M	556735897217	9328837923	
16	13	BOALIA (036)	SANU BIBI	RAMAN SK.	310/NEW, BOALIA	GENERAL	Minority	F	263584597345	9593056649	
17	13	BOALIA (036)	ABUL KALAM SARKAR	ABUL HALIM SARKAR	315/NEW, BOALIA	GENERAL	Minority	M	569495643486	7797325020	







CHAIRMAN
KANDI MUNICIPALITY

Sl. No.	Ward No	SLUM /Non Slum	Name of Beneficiary	Father's Name / Husband's Name	Holding No./Address	Category		Gender	Adhaar No.	Mob No.	Photo
						General/S.C./O.B. C./S.T	Minority				
18	13	BOALIA (036)	BANDISH KHAN	ABED KHAN	130/C, BOALIA	GENERAL	Minority	M	870944094413	9609049225	
19	13	BOALIA (036)	SUJITA BIBI	DILDAR KHAN	132/NEW, BOALIA	GENERAL	Minority	F	985559770002	960949226	
20	13	BOALIA (036)	BUJU KHAN	MD. MAFIL KHAN	190/C, BOALIA	GENERAL	Minority	M	589912813753	7385737548	

 CHAIRMAN
 KANDI MUNICIPALITY

PMAY (HFA- 2019-20)



BENEFICIARY LIST OF KANDI MUNICIPALITY

Sl. No.	Ward No	SLUM /Non Slum	Name of Beneficiary	Father's Name / Husband's Name	Holding No./Address	Category		Gender	Adhaar No.	Mob No.	Photo
						General/S.C./O.B. C./S. T	Minority				
1	14	PIRTALA CHASAPARA (037)	SAIRUDDIN SK	ABDUL HAMID	PIRTALA CHASAPARA	GENERAL	MINORITY	M	494657719816	7432871275	
2	14	PIRTALA CHASAPARA (037)	INDRAJIT MONDAL	GANAPATI MONDAL	BANIKPARA	OBC	NO	M	275008509503	8918734089	
3	14	BANDHERPA RA(038)	PALASH DHAR	GOLAK BIHARI DHAR	BANIKPARA	GENERAL	NO	M	347613006956	8972692479	
4	14	BANDHERPA RA(038)	SASTHI BARAL	LT. NARAYAN CHANDRA BARAL	CHHATINAKANDI	GENERAL	NO	M	729092673059	9002302162	
5	14	BANDHERPA RA(038)	RABI DUTTA	PASHUPATI DUTTA	CHHATINAKANDI	GENERAL	NO	M	390299618663	8293286573	

CHAIRMAN
KANDI MUNICIPALITY

PMAY (HFA- 2019-20)



BENEFICIARY LIST OF KANDI MUNICIPALITY

Sl. No.	Ward No	SLUM /Non Slum	Name of Beneficiary	Father's Name / Husband's Name	Holding No./Address	Category		Gender	Adhaar No.	Mob No.	Photo
						General/S.C./O.B. C./S.T	Minority				
1	14	BAGDIPARA (038)	PARESH DAS	LT. SUDHIR DAS	BAGDIPARA	OBC	NO	M	783274241208	7872595173	
2	14	BAGDIPARA (038)	KISHAN RAJAK	LT. ASIT MOHAN RAJAK	BANIKPARA	S.C.	NO	M	857657661113	84366391419	
3	14	PIRTALA CHASAPARA (037)	SEFALI BIBI	MINARUL SK	BANIKPARA	NO	YEA	F	748021616407	9593806080	

CHAIRMAN
KANDI MUNICIPALITY

PMAY (HFA- 2019-20)









BENEFICIARY LIST OF KANDI MUNICIPALITY

Sl. No.	Ward No	SLUM /Non Slum	Name of Beneficiary	Father's Name / Husband's Name	Holding No./Address	Category		Gender	Adhaar No.	Mob No.	Photo
						General/S.C./O.B. C./S.T	Minority				
1	14	KATHGOLA (058)	SURESH DAS	LT. BHAGIRATH DAS	KATHGOLA	S.C.	NO	M	830760335755	8145075132	
2	14	KATHGOLA (058)	GOURAV MONDAL	PRABHAT MONDAL	KATHGOLA	OBC	NO	M	495956403567	7432948348	
3	14	KATHGOLA (058)	SASTHI CHARAN DEY	KANAI CHANDRA DEY	KATHGOLA	GENERAL	NO	M	345477153613	9735490498	





CHAIRMAN
KANDI MUNICIPALITY

PMAY (HFA- 2019-20)

BENEFICIARY LIST OF KANDI MUNICIPALITY

Sl. No.	Ward No	SLUM /Non Slum	Name of Beneficiary	Father's Name / Husband's Name	Holding No./Address	Category		Gender	Adhaar No.	Mob No.	Photo
						General/S.C./O.B. C./S.T	Minority				
1	14	BANDHERPA RA(038)	HEMANTA SEN	LT. KAMALA KANTA SEN	BANDHERPAR	GENERAL	NO	M	50869576327	9232550557	
2	14	BANDHERPA RA(038)	SUJOY BISWAS	SUDHIR KR. BISWAS	BANDHERPAR	GENERAL	NO	M	322539517119	9833366341	
3	14	BANDHERPA RA(038)	MITHILESH GUPTA	LT. JANAM PRASAD GUPTA	BANDHERPAR	OBC	NO	M	703919983659	8436595606	
4	14	BANDHERPA RA(038)	SAILEN DAS	KANCHAN DAS	BANDHERPAR	OBC	NO	M	730212720455	8617594368	
5	14	BANDHERPA RA(038)	BISWANATH HAZRA	LT. SHAKTIPADO HAZRA	BANDHERPAR	S.C	NO	M	879299160837	9434859978	
6	14	BANDHERPA RA(038)	SWET KANTHA CHOWDHURY	ALOKE CHOWDHURY	BANDHERPAR	OBC	NO	M	451073019705	8116161246	
7	14	BANDHERPA RA(038)	PUTUL NANDI	SUSHIL NANDI	BANDHERPAR	GENERAL	NO	F	997695767963	7478168617	
8	14	BANDHERPA RA(038)	NIKHIL KR. GHOSH	NALINI MOHAN GHOSH	BANIKPARA	OBC	NO	M	602755950698	9564387603	

CHAIRMAN
KANDI MUNICIPALITY

Sl. No.	Ward No	SLUM /Non Slum	Name of Beneficiary	Father's Name / Husband's Name	Holding No./Address	Category		Gender	Adhaar No.	Mob No.	Photo
						General/S.C./O.B. C./S.T.	Minority				
9	14	BANDHERPA RA(038)	KRISHINA ROY	PRASANTA KR ROY	BANIKPARA	OBC	NO	M	609542918996	9775678208	
10	14	BANDHERPA RA(038)	SUMI DAS	SRIKANTA DAS	BANIKPARA	S C	NO	F	703914039291	6297978183	
11	14	BANDHERPA RA(038)	RABINDRANA BHATTACHARJEE	SANAT BHATTACHARJEE	BANIKPARA	GENERAL	NO	M	237369462848	8918324646	
12	14	BANDHERPA RA(038)	ANOJ KUMAR DAS	LT. SUKHEN DAS	BANIKPARA	OBC	NO	M	393329977812	9647454818	



CHAIRMAN
KANDI MUNICIPALITY

PMAY (HFA- 2019-20)





BENEFICIARY LIST OF KANDI MUNICIPALITY

Sl. No.	Ward No	SLUM /Non Slum	Name of Beneficiary	Father's Name / Husband's Name	Holding No./Address	Category		Gender	Adhaar No.	Mob No.	Photo
						General/S.C./O.B. C./S.T	Minority				
1	15	HOTELPARA (039)	INDRANI ROY	SUJIT KUMAR ROY	NEW, HOTELPARA	GENERAL	NO	F	907186988693	6297758355	
2	15	HOTELPARA (039)	PRATIMA MUKHERJEE	SAMIR MUKHERJEE	16/23/1, HOTELPARA	GENERAL	NO	F	56634716594	8001847628	
3	15	HOTELPARA (039)	RABINDRA NATH BITTAR	EKKARI BITTAR	NEW/47, HOTELPARA	GENERAL	NO	M	426464141388	9647389935	
4	15	HOTELPARA (039)	KUSH KUMAR BHATTACHARYA	KRISHNA KUMAR BHATTACHARYA	176/270/1, HOTELPARA	GENERAL	NO	M	707058915344	7718373019	
5	15	HOTELPARA (039)	MANOKKA BIBI	MANSUR SK.	43/9, HOTELPARA	GENERAL	Minority	F	393618564604	8348825631	

CHAIRMAN
KANDI MUNICIPALITY

PMAY (HFA - 2019-20)

BENEFICIARY LIST OF KANDI MUNICIPALITY





Sl. No.	Ward No.	SLUM /Non Slum	Name of Beneficiary	Father's Name / Husband's Name	Holding No./Address	Category		Gender	Adhaar No.	Mob No.	Photo
						General/S.C./O.B. C./S.T	Minority				
1	15	JELOPARA (060)	GOUR KAIBARTTA	BHAKTI KAIBARTTA	187/347/1, RUPPUR JELOPARA	SC	NO	M	35898856794 3	9800437996	
2	15	JELOPARA (060)	NETAI CHANDRA SAHA	HARIPADA SAHA	29/1, RUPPUR JELOPARA	SC	NO	M	64332323035 6	8145748323	
3	15	JELOPARA (060)	DIHANU SAHA	NARAYAN SAHA	32/10/A, RUPPUR JELOPARA	SC	NO	M	58003881175 5	8001484646	
4	15	JELOPARA (060)	SUBRATA BHATTACHARJEE	ANATH BANDHU BHATTACHARJEE	179/266-376/1, RUPPUR JELOPARA	GENERAL	NO	M	64737120523 8		



CHAIRMAN
KANDI MUNICIPALITY

PMAY (HFA- 2019-20)

BENEFICIARY LIST OF KANDI MUNICIPALITY

Sl. No.	Ward No	SLUM /Non Slum	Name of Beneficiary	Father's Name / Husband's Name	Holding No./Address	Category		Gender	Adhaar No.	Mob No.	Photo
						General/S.C./O.B. C./S.T	Minority				
1	15	COLONY (061)	JHARNA CHAKRABORTY	BISWAJIT CHAKRABORTY	161/A/226, RUPPUR COLONY	GENERAL	NO	F	308724897887	9733675951	
2	15	COLONY (061)	PARIBALA MONDAL	BASUDEB MONDAL	RUPPUR COLONY	GENERAL	NO	F	204541640556	8617545832	
3	15	COLONY (061)	SANTANU BOSE	SHIBSNKAR BOSE	RUPPUR COLONY	GENERAL	NO	M	543679437508	9474580079	
4	15	COLONY (061)	UTPAL BHATTACHARYA	NIHAR KUMAR BHATTACHARYA	RUPPUR COLONY	GENERAL	NO	M	312313211722	9851616761	
5	15	COLONY (061)	DIPOK ROY	SAILENDRA NATH ROY	182/C/350/1, RUPPUR COLONY	GENERAL	NO	M	390289669234	9547950151	
6	15	COLONY (061)	AMARENDRA NATH SARKAR	UMAPATI SARKAR	RUPPUR COLONY	GENERAL	NO	M	877116586140	7699252211	
7	15	COLONY (061)	BIMAL SINGHA	SAILENDRA NATH ROY	56/358, RUPPUR COLONY	GENERAL	NO	M	526838577428	9002403345	
8	15	COLONY (061)	BAIDYA NATH RAKSHIT	BENUKAR RAKSHIT	23/A/35, RUPPUR COLONY	GENERAL	NO	M	525228614348	9775545715	
9	15	COLONY (061)	JOYDEV GHOSHI	JAHARLAL GHOSH	58/A/146, RUPPUR COLONY	GENERAL	NO	M	414916539948	9732979116	











 CHAIRMAN
 KANDI MUNICIPALITY

Sl. No.	Ward No	SLUM/Non Slum	Name of Beneficiary	Father's Name / Husband's Name	Holding No./Address	Category		Gender	Adhaar No.	Mob No.	Photo
						General/S.C./O.B. C./S.T	Minority				
10	15	COLONY (061)	SADHIN KUMAR MUKHEREE	NITAI PADA MUKHEREE	72/180, RUPPUR COLONY	GENERAL	NO	M	417456677632	8101517998	



CHAIRMAN
KANDI MUNICIPALITY

PMAY (HFA- 2019-20)

BENEFICIARY LIST OF KANDI MUNICIPALITY

Sl. No.	Ward No	SLUM /Non Slum	Name of Beneficiary	Father's Name / Husband's Name	Holding No./Address	Category		Gender	Adhaar No.	Mob No.	Photo
						General/S.C./O.B. C./S.T	Minority				
1	16	(SC 040) HAZRAPARA	SNEHANGSU NANDI	LT. SHITANGSHU NANDI	BANIKPARA, BAGDANGA	GENERAL	NO	M	507446692530	7501035219	
2	16	(SC 040) HAZRAPARA	BIJOY HAZRA	DHANAPATI HAZRA	HAZRAPARA	SC	NO	M	284598231990		
3	16	(SC 040) HAZRAPARA	ABHIJIT HAZRA	NIMAI HAZRA	HAZRAPARA	SC	NO	M	456240472929		
4	16	(SC 040) HAZRAPARA	BHOLANATH BAGDI	BRINDABAN BAGDI	HAZRAPARA	SC	NO	M	580380643605		
5	16	(SC 040) HAZRAPARA	MILAN MONDAL	ASIT MONDAL	HAZRAPARA	GENERAL	NO	M	927737934636		
6	16	(SC 040) HAZRAPARA	BANDANA BHATTACHARYA	SHYAM BADAN BHATTACHARYA	BAGDANGA	GENERAL	NO	F	568307880732		
7	16	(SC 040) HAZRAPARA	ARUP BHATTACHARYA	PARESH NATH BHATTACHARYA	BAGDANGA	GENERAL	NO	M	303474488683		
8	16	(SC 040) HAZRAPARA	SUMITRA MONDAL	RAM PRASAD MONDAL	BAGDANGA	GENERAL	NO	F	404862508365		
9	16	(SC 040) HAZRAPARA	TARUN KONAI	ANIL KONAI	BAGDANGA	SC	NO	M	818978853863		











CHAIRMAN
KANDI MUNICIPALITY

Sl. No.	Ward No	SLUM /Non Slum	Name of Beneficiary	Father's Name / Husband's Name	Holding No./Address	Category		Gender	Adhaar No.	Mob No.	Photo
						General/S.C./O.B. C./S.T	Minority				
10	16	(ISC (H)) HAZRAPARA	LAKSHMIRANI GUJIN	PRAFULLA KUMAR GUJIN	BAGDANGA	GENERAL	NO	F	477812900596		



CHAIRMAN
KANDI MUNICIPALITY

PMAY (HFA- 2019-20)

BENEFICIARY LIST OF KANDI MUNICIPALITY

Sl. No.	Ward No	SLUM /Non Slum	Name of Beneficiary	Father's Name / Husband's Name	Holding No./Address	Category		Gender	Adhaar No.	Mob No.	Photo
						General/S.C./O.B. C./S.T	Minority				
1	16	(SC 040) HAZRAPARA	SNEHANGSU NANDI	LT. SHITANGSHU NANDI	BANIKPARA, BAGDANGA	GENERAL	NO	M	507446692530	7501035219	
2	16	(SC 040) HAZRAPARA	BIJOY HAZRA	DHANAPATI HAZRA	HAZRAPARA	SC	NO	M	284598231990		
3	16	(SC 040) HAZRAPARA	ABHIJIT HAZRA	NIMAI HAZRA	HAZRAPARA	SC	NO	M	456240472929		
4	16	(SC 040) HAZRAPARA	BHOLANATH BAGDI	BRINDABAN BAGDI	HAZRAPARA	SC	NO	M	580380643605		
5	16	(SC 040) HAZRAPARA	MILAN MONDAL	ASIT MONDAL	HAZRAPARA	GENERAL	NO	M	927737934636		
6	16	(SC 040) HAZRAPARA	BANDANA BHATTACHARYA	SHYAM BADAN BHATTACHARYA	BAGDANGA	GENERAL	NO	F	568307880732		
7	16	(SC 040) HAZRAPARA	ARUP BHATTACHARYA	PARESH NATH BHATTACHARYA	BAGDANGA	GENERAL	NO	M	303474488683		
8	16	(SC 040) HAZRAPARA	SUMITRA MONDAL	RAM PRASAD MONDAL	BAGDANGA	GENERAL	NO	F	404862508365		
9	16	(SC 040) HAZRAPARA	TARUN KONAI	ANIL KONAI	BAGDANGA	SC	NO	M	818978853863		











CHAIRMAN
KANDI MUNICIPALITY

Sl. No.	Ward No	SLUM /Non Slum	Name of Beneficiary	Father's Name / Husband's Name	Holding No./Address	Category		Gender	Adhaar No.	Mob No.	Photo
						General/S.C./O.B. C./S.T	Minority				
10	16	(SC (40)) HAZRAPARA	LAKSHMIRANI GUIN	PRAFULLA KUMAR GUIN	BAGDANGA	GENERAL	NO	F	477812900596		

CHAIRMAN
KANDI MUNICIPALITY

PMAY (HFA- 2019-20)

BENEFICIARY LIST OF KANDI MUNICIPALITY

Sl. No.	Ward No	SLUM /Non Slum	Name of Beneficiary	Father's Name / Husband's Name	Holding No./Address	Category		Gender	Adhaar No.	Mob No.	Photo
						General/S.C./O.B. C./S.T	Minority				
1	16	(SC 041) LET KONAIPARA	ANIRUDDHA ROY	INDRAJIT ROY	BAGDANGA	GENERAL	NO	M	841345560613		
2	16	(SC 041) LET KONAIPARA	ARGHA ROY	LT. SUPRABHAT ROY	SARANGPUR, BAGDANGA	GENERAL	NO	M	940030057327	8371979553	
3	16	(SC 041) LET KONAIPARA	SHANTA KONAI	LT. HARI KONAI	SARANGPUR, BAGDANGA	SC	NO	M	499286248732	8436332998	
4	16	(SC 041) LET KONAIPARA	TARUN KONAI	ANIL KONAI	SARANGPUR, BAGDANGA	SC	NO	M	818978853863	97322750138	
5	16	(SC 041) LET KONAIPARA	SATYA NARAYAN DAS	LT. UMAPADA DAS	SARANGPUR, BAGDANGA	SC	NO	M	966531650180	9800130430	
6	16	(SC 041) LET KONAIPARA	JOGMAYA LATE	LT. BADAL LATE	SARANGPUR, BAGDANGA	SC	NO	F	495144116138	7872710021	
7	16	(SC 041) LET KONAIPARA	SANDHYA DAS	PROSANTA DAS	BAGDANGA	GENERAL	NO	F	691107382406		
8	16	(SC 041) LET KONAIPARA	PINKU MONDAL	DULAL MONDAL	BAGDANGA	GENERAL	NO	M	260861772470		
9	16	(SC 041) LET KONAIPARA	SONALI KONAI	ASUDEB KONAI	KONAIPARA	SC	NO	F	791714054742		









CHAIRMAN
KANDI MUNICIPALITY

Sl. No.	Ward No.	SLUM /Non Slum	Name of Beneficiary	Father's Name / Husband's Name	Holding No./Address	Category		Gender	Adhaar No.	Mob No.	Photo
						General/S.C./O.B. C./S.T.	Minority				
10	16	(SC 041) LET KONAIPARA	LAKSHMAN KONAI	LT. KASHINATH KONAI	KONAIPARA	SC	NO	M	933119718874		



CHAIRMAN
KANDI MUNICIPALITY

PMAY (HFA- 2019-20)

BENEFICIARY LIST OF KANDI MUNICIPALITY

Sl. No.	Ward No	SLUM /Non Slum	Name of Beneficiary	Father's Name / Husband's Name	Holding No./Address	Category		Gender	Adhaar No.	Mob No.	Photo
						General/S.C./O.B. C./S.T	Minority				
1	16	(SC 042) SAHISPARA	RAOSHANA BIBI	LT. KAMAL SK.	SAHISPARA, BAGDANGA	GENERAL	Minority	F	478115813390	9734516288	
2	16	(SC 042) SAHISPARA	BADAM SEKH	DALIK SEKH	SAHISPARA, BAGDANGA	GENERAL	Minority	M	646643960490	9635262393	
3	16	(SC 042) SAHISPARA	UJJAL KHAN	LT. GULU KHAN	SAHISPARA, BAGDANGA	GENERAL	Minority	M	69995690099	8670894846	
4	16	(SC 042) SAHISPARA	NIJAM SEKH	LT. TELAM SK.	SAHISPARA, BAGDANGA	GENERAL	Minority	M	837461779763	6295718947	
5	16	(SC 042) SAHISPARA	MILAN SK.	LT. NUJMAHAMMAD SK.	SAHISPARA, BAGDANGA	GENERAL	Minority	M	552639933893	9647602118	
6	16	(SC 042) SAHISPARA	SRIKANTA DAS	AJIT DAS	BAGDANGA	SC	NO	M	628129013948		
7	16	(SC 042) SAHISPARA	PUSPA PAL	MAHADEB PAL	BAGDANGA	GENERAL	NO	F	832506940128		
8	16	(SC 042) SAHISPARA	SANTI CHARAN GANGULI	MANMATHA GANGULI	BAGDANGA	GENERAL	NO	M	501339143188		
9	16	(SC 042) SAHISPARA	ANANTA DAS	KURURAM DAS	BAGDANGA	SC	NO	M	666141098346		











CHAIRMAN
KANDI MUNICIPALITY

Sl. No.	Ward No	SLUM /Non Slum	Name of Beneficiary	Father's Name / Husband's Name	Holding No./Address	Category		Gender	Adhaar No.	Mob No.	Photo
						General/S.C./O.B. C./S.T	Minority				
10	18	(SC-042) SAHISPARA	HARADHAN DAS	DHIRU DAS	BAGDANGA	SC	NO	M	672730736482		





PMAY (HFA- 2019-20)

BENEFICIARY LIST OF KANDI MUNICIPALITY

Sl. No.	Ward No	SLUM/Non Slum	Name of Beneficiary	Father's Name / Husband's Name	Holding No./Address	Category		Gender	Adhaar No.	Mob No.	Photo
						General/S.C./O.B. C./S.T	Minority				
1	17	SC 043 PROVAKARPARA RA	SATYA KUMAR DAS	SHAYAMACHARAN DAS	11/B/67 PROVAKARPARA	OBC	NO	M	283745885507	9635589395	
2	17	SC 043 PROVAKARPARA RA	MILAN MUKHERJEE	NITAL MUKHERJEE	28/B/13 PROVAKARPARA	GEN	NO	M	228409619533	9475361772	
3	17	SC 043 PROVAKARPARA RA	PARTHA SHIL	BUJOY KUMAR SHIL	NEW 26/A PROVAKARPARA	OBC	NO	M	976808453537	6297948893	
4	17	SC 043 PROVAKARPARA RA	HIRU CHANDRA MONDAL	BISWANATH MONDAL	33 PROVAKARPARA	SC	NO	M	689528031123	7063535966	
5	17	SC 043 PROVAKARPARA RA	SHIB NARAYAN DAS	LAKSHIMI NARAYAN DAS	NEW178/A PROVAKARPARA	OBC	NO	M	904428688600	9564468537	
6	17	SC 043 PROVAKARPARA RA	BISWAJIT CHAKRABORTY	DHANESWAR CHAKRABORTY	N177/D PROVAKARPARA	GEN	NO	M	678827524829	9836619691	
7	17	SC 043 PROVAKARPARA RA	SUBHASH MONDAL	AMILUYA MONDAL	NEW PROVAKARPARA	SC	NO	M	440689464974	9233675811	
8	17	SC 043 PROVAKARPARA RA	UJJIWAL DAS	LT ANANDA DULAL DAS	52/B/50 PROVAKARPARA	GEN	NO	M	370245402855	9749232540	
9	17	SC 043 PROVAKARPARA RA	DEBIPRASAD BHANDARI	LT PRAFULA KUMAR BHANDARI	61/B PROVAKARPARA	OBC	NO	M	296037031390	8001824413	





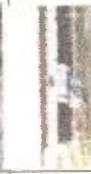





CHAIRMAN
KANDI MUNICIPALITY

Sl. No.	Ward No	SLUM /Non Slum	Name of Beneficiary	Father's Name / Husband's Name	Holding No./Address	Category		Gender	Adhaar No.	Mob No.	Photo
						General/S.C./O.B. C./S.T	Minority				
10	17	SC 043 PROVAKARPA RA	NAMITA DAS	JYOTIS DAS	N/138 PROVAKARPARA	GEN	NO	F	871721964772	9775168562	
11	17	SC 043 PROVAKARPA RA	KARTIK MONDAL	BIRUPADA MONDAL	NEW PROVAKARPARA	OBC	NO	M	833004408039	8653737803	
12	17	SC 043 PROVAKARPA RA	APURBA DAS	LT LAKSHMI NARAYAN DAS	NEW PROVAKARPARA	GEN	NO	M	779795880980	8617332823	
13	17	SC 043 PROVAKARPA RA	GOUTAM DAS	ATUL CHANDRA DAS	NEW PROVAKARPARA	GEN	NO	M	378443506307	9734387039	
14	17	SC 043 PROVAKARPA RA	MANIK NANDI	LATE KALI FADIA NANDI	NEW 61/N PROVAKARPARA	GEN	NO	M	717284255457	9932665098	
15	17	SC 043 PROVAKARPA RA	SOMNATH PRAMANIK	CHAND PRAMANIK	BB/C PROVAKARPARA	GEN	NO	M	874963079997	9647034749	











CHAIRMAN
KANDI MUNICIPALITY

PMAY (HFA- 2019-20)









BENEFICIARY LIST OF KANDI MUNICIPALITY

Sl. No.	Ward No	SLUM /Non Slum	Name of Beneficiary	Father's Name / Husband's Name	Holding No./Address	Category		Gender	Adhaar No.	Mob No.	Photo
						General/S.C./O.B. C./S.T	Minority				
1	18	SC038 BAGDIPARA	KALI BAGDI	ASHOKE BAGDI	173N	S.C.	NO	F	995831013077	9635530742	
2	18	SC038 BAGDIPARA	PURNIMA PAL	LT. PANKAJ PAL	626/A/7	OBC	NO	F	386282545734	6327065977	
3	18	SC038 BAGDIPARA	SHILPI NANDI	RABIN NANDI	174 N	GENERAL	NO	F	998589062553	9735331930	
4	18	SC038 BAGDIPARA	BULU BAGDI	LT. ANANDA BAGDI	126/B/1	S.C.	NO	F	601022984244	7864975135	
5	18	SC038 BAGDIPARA	SRIKANTA DAS	LT. SADAI DAS	129/A	S.C.	NO	M	493502813233	9749934047	
6	18	SC038 BAGDIPARA	SUSHANTA DAS	LT. DHANANJAY DAS	151/B/2	S.C.	NO	M	541180342762	7044347587	
7	18	SC038 BAGDIPARA	NAYAN BAGDI	LT. MAHADEB BAGDI	151/B/3	S.C.	NO	M	799922731396	9733573906	
8	18	SC038 BAGDIPARA	PARBATI HAZRA	LT. MADHAB HAZRA	155/A	S.C.	NO	F	688960804375	8101941094	







CHAIRMAN
KANDI MUNICIPALITY

Sl. No.	Ward No	SLUM /Non Slum	Name of Beneficiary	Father's Name / Husband's Name	Holding No./Address	Category		Gender	Adhaar No.	Mob No.	Photo
						General/S.C./O.B.C./S.T	Minority				
9	18	SC038 BAGDIPARA	DHULI ROY	BISWANATH ROY	157N	GENERAL	NO	F	584919036257	8370861187	
10	18	SC038 BAGDIPARA	SWADHIN DAS	LT. DURGAPADA DAS	157/A/1	SC	NO	M	625616186342	8327608277	
11	18	SC038 BAGDIPARA	BANI DAS	BIDYUT DAS	626/N	SC	NO	F	959980749843	7718794096	
12	18	SC038 BAGDIPARA	TAPAN DAS	DURGAPADA DAS	111N	SC	NO	M	570858752771	8371873924	
13	18	SC038 BAGDIPARA	SAGARI DAS	JOYDEB DAS	127/C/2	SC	NO	F	261770011099	8101972632	
14	18	SC038 BAGDIPARA	SUNIL DAS	LT. HARI DAS	127/C/1	OBC	NO	M	841035199450	9734731512	
15	18	SC038 BAGDIPARA	UTPAL HAZRA	ANIL HAZRA	137/2	SC	NO	M	961774111595	8101215955	
16	18	SC038 BAGDIPARA	SHISHIR BANERJEE	LT. KANAI BANERJEE	212/B/2	GENERAL	NO	M	867324441047	7407478098	
17	18	SC038 BAGDIPARA	SULEKHA KUNDU	DWAIPAYAN KUNDU	212/A/1	GENERAL	NO	F	799234195117	7407305317	

CHAIRMAN
KANDI MUNICIPALITY

Sl. No.	Ward No	SLUM /Non Slum	Name of Beneficiary	Father's Name / Husband's Name	Holding No./Address	Category		Gender	Adhaar No.	Mob No.	Photo
						General/S.C./O.B. C./S.T	Minority				
18	18	SC038 BAGDIPARA	KARTICK MONDAL	GURUCHARAN MONDAL	212/A/1/2	GENERAL	NO	M	705396773856	9735084174	
19	18	SC038 BAGDIPARA	SHEFALI DAS	SUBAS DAS	177/A/1	S.C	NO	F	360640421115	8348879663	
20	18	SC038 BAGDIPARA	FUGANI BARIK	LT. BHANJAN BARIK212	177/A/2	S.C.	NO	F	547417009923	7966046303	
21	18	SC038 BAGDIPARA	KALYAN DAS	SHATRUGHNA DAS	172/KA/1	S.C.	NO	M	303507609438	6297754644	
22	18	SC038 BAGDIPARA	PROBHAT DAS	LT. ANADI DAS	172/KA/2	OBC	NO	M	273641672689	9932234991	
23	18	SC038 BAGDIPARA	NAREN KUMAR NANDI	AJIT NANDI	172/KA/3	GENERAL	NO	M	233689689874	7864032534	
24	18	SC038 BAGDIPARA	PARIMAL DAS	KASHINATH DAS	169/GA/1	S.C.	NO	M	366688439241	7872821331	
25	18	SC038 BAGDIPARA	SUBAL DAS BAIRAGYA	LT. ABANI DAS	134/GA/2	OBC	NO	M	547417009923	8001192305	
26	18	SC038 BAGDIPARA	SUJOY GHOSH	LT. PANNALAL GHOSH	211N	GENERAL	NO	M	541083096372	9932662132	









CHAIRMAN
KANDI MUNICIPALITY

Sl. No.	Ward No	SLUM /Non Slum	Name of Beneficiary	Father's Name / Husband's Name	Holding No./Address	Category		Gender	Adhaar No.	Mob No.	Photo
						General/S.C./O.B. C./S.T	Minority				
27	18	SC038 BAGDIPARA	ATUL DAS	LT. KARTICK DAS	214/A/2	OBC	NO	M	315357218816	8927431315	
28	18	SC038 BAGDIPARA	KAMLESH GUPTA	LT. JANARDAN PRASAD GUPTA	219/C/1	GENERAL	NO	M	924372302274	8436595606	
29	18	SC038 BAGDIPARA	MITHUN MANDAL	LT. MAHADEV MANDAL	220/A/1/2	GENERAL	NO	M	567484928304	9635232784	
30	18	SC038 BAGDIPARA	DHRUBA NATH DAS	LT. NARAYAN CHANDRA DAS	221/NEW	S C	NO	M	924230946370	8372072214	
31	18	SC038 BAGDIPARA	BHABASINDHU DAS	LT. NARAYAN CHANDRA DAS	230/A/1	S C	NO	M	296095892896	7076829202	
32	18	SC038 BAGDIPARA	BISWAI T PRAMANICK	SHIBRAM PRAMANICK	230/A/2	OBC	NO	M	554921222171	9475421180	





CHAIRMAN
KANDI MUNICIPALITY

PMAY (HFA- 2019-20)

BENEFICIARY LIST OF KANDI MUNICIPALITY

Sl. No.	Ward No	SLUM /Non Slum	Name of Beneficiary	Father's Name / Husband's Name	Holding No./Address	Category		Gender	Adhaar No.	Mob No.	Photo
						General/S.C./O.B. C./S.T	Minority				
1	1	NON SLUM	HAIMANTI CHATTERJEE	LT. HARIDAS CHATTERJEE	NATUNPARA	GEN	NO	FEMALE	408600042961	9091158187	
2	1	NON SLUM	DIPTIMOY GHOSH	KRISHNA DEB GHOSH	NATUNPARA	GEN	NO	MALE	700453548398	9734075727	
3	1	NON SLUM	SUPRABHAT GHOSH	LT. BIRENDRA KUMAR GHOSH	NATUNPARA	GEN	NO	MALE	529330733403	9332076331	
4	1	NON SLUM	PRADIP HALDER	LT. GANGA NARAYAN HALDER	DHALLAPARA	SC	NO	MALE	878000563246	9851679830	
5	1	NON SLUM	PARESH NATH BARIK	RUDRANATH BARIK	NEW/102/4 BANDHAPUKUR	SC	NO	MALE	560342274488	7001213795	
6	1	NON SLUM	SHYAMAL BARIK	LT. SASTI BARIK	BANDHAPUKUR	SC	NO	MALE	612816263170	8001762935	
7	1	NON SLUM	MOHAN BARIK	LT. SASTI BARIK	BANDHAPUKUR	SC	NO	MALE	660856617687	7679721636	
8	1	NON SLUM	MAHAMAYA KONAI	LT. KALIPADA KONAI	DHALLAPARA	SC	NO	FEMALE	908441078238	9734020976	







 CHAIRMAN
 KANDI MUNICIPALITY

Sl. No.	Ward No	SLUM /Non Slum	Name of Beneficiary	Father's Name / Husband's Name	Holding No./Address	Category		Gender	Adhaar No.	Mob No.	Photo
						General/S.C./O.B. C./S.T	Minority				
9	1	NON SLUM	HARADHAN CHATTARAJ	LT. ANIL CHATTARAJ	DHALLAPARA	GEN	NO	MALE	836249425546	9635072982	
10	1	NON SLUM	DILIP MONDAL	LT ANANTA KRISHNA MONDAL	CHASAPARA	GEN	NO	MALE	435589840399	9475020494	
11	1	NON SLUM	RAJIV KUMAR DAS	LT. RATAN DAS	63/NEW CHASAPARA	GEN	NO	MALE	694635489906	8145469784	
12	1	NON SLUM	SAJJIT MONDAL	LT. KARTICK CHANDRA MONDAL	113/115 BANDHAPUKUR	GEN	NO	MALE	648359293673	8001011522	





CHAIRMAN
KANDI MUNICIPALITY

PMAY (HFA - 2019-20)

BENEFICIARY LIST OF KANDI MUNICIPALITY

Sl. No.	Ward No	SLUM /Non Slum	Name of Beneficiary	Father's Name / Husband's Name	Holding No./Address	Category		Gender	Adhaar No.	Mob No.	Photo
						General/S.C./O.B. C./S.T	Minority				
1	2	NON SLUM	BIDYA SINHA	LT. KULESHENDRA SINHA	KANDI BAZAR	GENERAL	NO	M	265768651453	6296006760	
2	2	NON SLUM	SANTANA DALUI	LT. NARAN DALUI	KANDI KALABAGAN	SC	NO	F	226793839044	8617026470	
3	2	NON SLUM	PURNACHANDRA SAHANI	BATARAM SAHANI	KANDI KALABAGAN	GENERAL	NO	M	393137213210	9475202258	
4	2	NON SLUM	SHNEHASHIS GHOSH	LT. KANCHAN KUMAR GHOSH	KANDI KALABAGAN	GENERAL	NO	M	634719633673	9434482290	
5	2	NON SLUM	SADHIN DUTTA	LT. MADAN MOHAN DUTTA	KANDI BAZAR	GENERAL	NO	M	306800825572	9735272953	
6	2	NON SLUM	BENU BARIK	LT. JATI BARIK	KANDI BANDHAPUKUR	SC	NO	M	917260569281	9475202258	
7	2	NON SLUM	ASHIM KUMAR MONDAL	LT. SATYANARAYAN MONDAL	KANDI BANDHAPUKUR	GENERAL	NO	M	218070109675	9475202258	
8	2	NON SLUM	SHUBHRA PRODHAN	LT. AUOY PRODHAN	KANDI BANDHAPUKUR	SC	NO	F	801236887304	7797179384	
9	2	NON SLUM	BHARAT HALDER	LT. DHIREN HALDER	KANDI BANDHAPUKUR	GENERAL	NO	M	334167555318	9475202258	







CHAIRMAN
KANDI MUNICIPALITY

Sl. No.	Ward No	SLUM /Non Slum	Name of Beneficiary	Father's Name / Husband's Name	Holding No./Address	Category		Gender	Adhaar No.	Mob No.	Photo
						General/S.C./O.B. C./S.T	Minority				
10	2	NON SLUM	JHUMA BARIK	BISWANATH BARIK	KANDI BANDHAPUKUR	S.C	NO	F	548668779919	8293435643	
11	2	NON SLUM	APURBA KUMAR PAL	BANSHI BADAN PAL	KANDI BANDHAPUKUR	GENERAL	NO	M	363486974756	8016412236	
12	2	NON SLUM	KRISHNA DAS	LT. DHIREN DAS	KANDI BANDHAPUKUR	GENERAL	NO	M	627442813674	9564183452	
13	2	NON SLUM	BIDYUT BARIK	LT. GOPAL BARIK	KANDI BANDHAPUKUR	S.C	NO	M	722564846597	9647100555	
14	2	NON SLUM	CHANDAN ROY	LT. TULSHI ROY	KANDI BANDHAPUKUR	GENERAL	NO	M	669167159049	7872400827	

CHAIRMAN
KANDI MUNICIPALITY

PMAY (HFA- 2019-20)











BENEFICIARY LIST OF KANDI MUNICIPALITY









Sl. No.	Ward No	SLUM /Non Slum	Name of Beneficiary	Father's Name / Husband's Name	Holding No./Address	Category		Gender	Adhaar No.	Mob No.	Photo
						General/S.C./O.B. C./S.T	Minority				
1	3	NON SLUM	DEBDAS DAS	LATE ANATHBANDHU DAS	KANDI SHYAMBAZAR	GENERAL	NO	M	979538669127	8250779790	
2	3	NON SLUM	MINATI DAS	SUNIL KUMAR DAS	KANDI PANCHACHHIYA	GENERAL	NO	F	762592696098	9434605828	
3	3	NON SLUM	MUKTI BISWAS	DIPANKAR BISWAS	KANDI JIBDHARPARA	S.C.	NO	F	452551442746	8436888031	
4	3	NON SLUM	JAYASREE GOSWAMI	SUPRIYA GOSWAMI	KANDI JIBDHARPARA	GENERAL	NO	F	669055078357	9851023717	
5	3	NON SLUM	PRASHANTA ROOJ	BIBHUTI BHUSAN ROOJ	MOLLAPARA	GENERAL	NO	M	998269713526	8653330890	

 CHAIRMAN
 KANDI MUNICIPALITY

PMAY (HFA- 2019-20)

BENEFICIARY LIST OF KANDI MUNICIPALITY

Sl. No.	Ward No	SLUM /Non Slum	Name of Beneficiary	Father's Name / Husband's Name	Holding No./Address	Category		Gender	Adhaar No.	Mob No.	Photo
						General/S.C./O.B. C./S.T.	Minority				
1	4	NON SLUM	KRISHNA DHAR	LT. JASODA DULAL DHAR	53/C/144, LAHIRIPARA	OBC	NO	F	770431428019		
2	4	NON SLUM	DIPAK KAIBARTYA	LT. KANU KAIBARTYA	27/B/194, LAHIRIPARA	SC	NO	M	939890634263	9775443547	
3	4	NON SLUM	BANI CHAKRABORTY	LT. RAGHAB CHAKRABORTY	3/F/27, GOPINATHPUR	GENERAL	NO	F	780631401348	9735668214	
4	4	NON SLUM	UJWAL DUTTA	LT. MONORANJAN DUTTA	5/25, GOPINATHPUR	GENERAL	NO	M	885069607216	9434639273	
5	4	NON SLUM	RAJKUMAR KUNDU	DHIREN KUNDU	31/B/227, GOPINATHPUR	OBC	NO	M	329165462092	9932602248	
6	4	NON SLUM	AJAY DAS	LT. KARTICK CHANDRA DAS	45/B/120, GOPINATHPUR	OBC	NO	M	690885508241	9734935600	
7	4	NON SLUM	BIJOY DAS	LT. KARTIK CHANDRA DAS	45/B/120, GOPINATHPUR	OBC	NO	M	840180905824		
8	4	NON SLUM	SUSANTA CHATTERJEE	SAMARENDRANATH CHATTERJEE	22/70, GOPINATHPUR	GENERAL	NO	M	782166084510	9382061070	
9	4	NON SLUM	UTPAL DUTTA	PARTHA DUTTA	41/112, GOPINATHPUR	OBC	NO	M	885069607216	9734849417	
10	4	NON SLUM	DILIP PRODHAN	GANAPATI PRODHAN	DAG-2631, BHOLANATHPUR	SC	NO	M	447665453652	9647992732	









Sl. No.	Ward No	SLUM /Non Slum	Name of Beneficiary	Father's Name / Husband's Name	Holding No./Address	Category		Gender	Adhaar No.	Mob No.	Photo
						General/S.C./O.B. C./S.T	Minority				
11	4	NON SLUM	SUBHAJIT DAS	LT. MADHUSUDHAN DAS	DAG-2589, BHOLANATHPUR	OBC	NO	M	486474668514		
12	4	NON SLUM	MONOJ KUMAR DAS	SUNIL DAS	21/2, BHOLANATHPUR	OBC	NO	M	447665453652	9647556517	
13	4	NON SLUM	SABITA KUNDU	LT. BAIDYANATH KUNDU	37/C/31, BHOLANATHPUR	OBC	NO	F	475207410411	9735349539	
14	4	NON SLUM	PRASANTA KUMAR DAS	KAPIL CHANDRA DAS	27/B/94, LAHIRIPARA	OBC	NO	M	491864923265	9475421932	
15	4	NON SLUM	AMAR KR. MONDAL	AHIBHUSAN MONDAL	26/88, LAHIRIPARA	GENERAL	NO	M	248878297642	7029255854	
16	4	NON SLUM	HRIDYOY ROY	LT. SATKARI ROY	21/73, GOPINATHPUR	GENERAL	NO	M	372505812447	7602506740	
17	4	NON SLUM	BANSHIBADAN DUTTA	LT. BISWANATH DUTTA	11/A/51, GOPINATHPUR	GENERAL	NO	M	851723417095	9732786760	
18	4	NON SLUM	KARUNA SINDHU KUNDU	LT. ANIL KUNDU	36/33, BHOLANATHPUR	OBC	NO	M	450460701918		













CHAIRMAN
KANDI MUNICIPALITY

PMAY (HFA- 2019-20)

BENEFICIARY LIST OF KANDI MUNICIPALITY

Sl. No.	Ward No	SLUM /Non Slum	Name of Beneficiary	Father's Name / Husband's Name	Holding No./Address	Category		Gender	Adhaar No.	Mob No.	Photo
						General/S.C./O.B. C./S.T	Minority				
1	7	NON SLUM	BIKASH CHANDRA ROY	LT. ARUN CHANDRA ROY	94/101, RASORAH	GENERAL	NO	M	958523874213	9564187208	
2	7	NON SLUM	JOYDEB MANDAL	KRISHNA CHARAN MANDAL	57/45, RASORAH	GENERAL	NO	M	979466442140	9749207221	
3	7	NON SLUM	UJJWAL MANDAL	LT. BASUDEB MANDAL	68/C/69, RASORAH	GENERAL	NO	M	876379459639	8101357218	
4	7	NON SLUM	CHANDANA MANDAL	KESHAB MANDAL	NEW, RASORAH	GENERAL	NO	F	400893963366	9647516718	
5	7	NON SLUM	BISWAJIT BANERJEE	LT. BIMENSH BANERJEE	NEW, RASORAH	GENERAL	NO	M	417432610177	9733541516	
6	7	NON SLUM	ASHISH MONDAL	LT. DURGACHARAN MONDAL	61/49, RASORAH	GENERAL	NO	M	771329038266	8420231903	
7	7	NON SLUM	SUBIR KUMAR MONDAL	DHANUPADA MONDAL	NEW, RASORAH	GENERAL	NO	M	391757728189	9735499758	
8	7	NON SLUM	GOURI DAS	DEBSAGAR DAS	104/A, RASORAH	S.C	NO	F	726921408655	9531696696	
9	7	NON SLUM	NANDADULAL GHOSH	LT. ARABINDA GHOSH	45/25, RASORAH	GENERAL	NO	M	526980805073	9547001232	

CHAIRMAN
KANDI MUNICIPALITY

Sl. No.	Ward No	SLUM /Non Slum	Name of Beneficiary	Father's Name / Husband's Name	Holding No./Address	Category		Gender	Adhaar No.	Mob No.	Photo
						General/S.C./O.B. C./S.T	Minority				
10	7	NON SLUM	BRINDABAN GHOSH	LT. DHIREN GHOSH	NEW, RASORAH	GENERAL	NO	M	50228897262	9734576515	
11	7	NON SLUM	RAM MONDAL	LAKSHMI MONDAL	102/112, RASORAH	GENERAL	NO	M	843512623762	7001733705	
12	7	NON SLUM	GOPAL PAL	SHIB SHANKAR PAL	111, RASORAH	GENERAL	NO	M	229350437326	9775966195	
13	7	NON SLUM	PINKI GHOSH	TAPAN GHOSH	NEW, RASORAH	GENERAL	NO	F	994826897236	8145091323	
14	7	NON SLUM	SURESH MONDAL	LT. SUKUMAR MONDAL	60/48, RASORAH	GENERAL	NO	M	719546340932	7797329503	
15	7	NON SLUM	MRINMOY MONDAL	KUBIR CHANDRA MONDAL	NEW, RASORAH	GENERAL	NO	M	489889728209	9679447468	
16	7	NON SLUM	ABHIJIT MONDAL	TAMAL MONDAL	NEW, RASORAH	GENERAL	NO	M	366170737815	8250529675	
17	7	NON SLUM	ALOKE BAGDI	LT. NITYA BAGDI	75/74, RASORAH	S.C	NO	M	661574201070	9064982585	
18	7	NON SLUM	RATHINDRANATH GHOSH	LT. CHANDRA SEKHAR GHOSH	62/52, RASORAH	GENERAL	NO	M	359355551274	8170921019	
19	7	NON SLUM	ARUP MONDAL	LT. NIMAI MONDAL	NEW, RASORAH	GENERAL	NO	M	656536639164	9564630654	

(Handwritten Signature)









CHAIRMAN
KANDI MUNICIPALITY

Sl. No.	Ward No	SLUM /Non Slum	Name of Beneficiary	Father's Name / Husband's Name	Holding No./Address	Category		Gender	Adhaar No.	Mob No.	Photo
						General/S.C./O.B. C./S.T	Minority				
20	7	NON SLUM	PRODIP MANDAL	LT. NANI GOPAL MANDAL	80/82/NEW, RASORAH	GENERAL	NO	M	768659604676	7047617667	
21	7	NON SLUM	BANKIM ROY	BIPRADAS ROY	92/100, RASORAH	GENERAL	NO	M	950991858515	7407717238	
22	7	NON SLUM	AMRIT PAL	LT. SANAKAN PAL	NEW, RASORAH	GENERAL	NO	M	668542182583	9126519292	







CHAIRMAN
KANDI MUNICIPALITY

PMAY (HFA- 2019-20)

BENEFICIARY LIST OF KANDI MUNICIPALITY

Sl. No.	Ward No	SLUM /Non Slum	Name of Beneficiary	Father's Name / Husband's Name	Holding No./Address	Category		Gender	Adhaar No.	Mob No.	Photo
						General/S.C./O. B.C./S.T	Minority				
1	9	NON SLUM	MADHAB CHANDRA DAS	KRISHNA CHANDRA DAS	NEW	GENERAL	NO	M	213095134806		
2	9	NON SLUM	SUDIP DAS	LT. KAMALAPADA DAS	NEW	GENERAL	NO	M	398066387531	9064956375	
3	9	NON SLUM	NIRMAL KUMAR DAS	RADHA GOBINDA DAS	NEW	GENERAL	NO	M	963537666677	7098914178	
4	9	NON SLUM	PINTU HAZRA	PARESH HAZRA	NEW	SC	NO	M	697882233157		
5	9	NON SLUM	PRASAMTA SINGHA	RAM CHANDRA SINGHA	NEW	GENERAL	NO	M	695766645811		
6	9	NON SLUM	KUSH KUMAR DAS	TARAPADA DAS	NEW	GENERAL	NO	M	987614992210		
7	9	NON SLUM	PRAKASH GHOSH	BHABANI SINDHU GHOSH	NEW	GENERAL	NO	M	392924110910		
8	9	NON SLUM	KARTICK GHOSH	BABU GHOSH	NEW	GENERAL	NO	M	438761943509		











 CHAIRMAN
 KANDI MUNICIPALITY

Sl. No.	Ward No	SLUM /Non Slum	Name of Beneficiary	Father's Name / Husband's Name	Holding No./Address	Category		Gender	Adhaar No.	Mob No.	Photo
						General/S.C./O. B.C./S.T	Minority				
9	9	NON SLUM	MANOJ DAS	LAKSHMI NARAYAN DAS	NEW	GENERAL	NO	M	887769557549		
10	9	NON SLUM	UJJWAL DAS	PRAFULLA DAS	NEW	GENERAL	NO	M	589396298404		
11	9	NON SLUM	NARAYAN DAS	NIRMAL DAS	NEW	GENERAL	NO	M	595857281358		
12	9	NON SLUM	BASUDEB GHOSH	DINABANDHU GHOSH	NEW	GENERAL	NO	M	770963936885		
13	9	NON SLUM	ARUP KUMAR DAS	JAGANNATH DAS	NEW	GENERAL	NO	M	796582098941		
14	9	NON SLUM	TANMOY CHAKRABORTY	SAROJ CHAKRABORTY	NEW	GENERAL	NO	M	831421114774		





 CHAIRMAN
 KANDI MUNICIPALITY

PMAY (HFA- 2019-20)

BENEFICIARY LIST OF KANDI MUNICIPALITY

Sl. No.	Ward No.	SLUM /Non Slum	Name of Beneficiary	Father's Name / Husband's Name	Holding No./Address	Category		Gender	Adhaar No.	Mob No.	Photo
						General/S.C./O.B. C./S.T	Minority				
1	11	NON SLUM	CHINTA BIBI	KIMAI SK	550/4 KALI BARI ROAD		YES	F	610502458324	8436891401	
2	11	NON SLUM	SUDHIR KUMAR MONDAL	SHRIPATI MONDA'	439/B KALIBARI ROAD		NO	M	477480037718	8001550688	
3	11	NON SLUM	SARASWATI DAS	UTTAM DAS	111/181 KALIBARI ROAD	SC	NO	F	656464126948	7797556825	
4	11	NON SLUM	PRIYANKA DUTTA	SUSHANTA DUTTA	404/B BIJOYNAGAR	GEN	NO	F	731776368226	7001866269	
5	11	NON SLUM	DIPAK CHUNARI	SHAYAMPADA CHUNARI	2/5/16/2 BIJOYNAGAR	SC	NO	M	999123862112	7872196005	
6	11	NON SLUM	PRASANTA CHUNARI	GORACHAND CHUNARI	519/6 BIJOYNAGAR	SC	NO	M	253220317261	8145173566	
7	11	NON SLUM	RAKHI SEN	MANIK SEN	234/F KALIBARI ROAD	GEN	NO	F	469849127634	9564003320	
8	11	NON SLUM	PARTHA PATRA	SWAPAN PATRA	26/52/49 BIJOYNAGAR	OBC	NO	M	297740892201	9047786156	
9	11	NON SLUM	SANTOSH ACHARJEE	LT DIBAKAR ACHERIEE	196/C/217 BIJOYNAGAR	GEN	NO	M	657221300851	9547237319	









CHAIRMAN
KANDI MUNICIPALITY



Sl. No.	Ward No	SLUM /Non Slum	Name of Beneficiary	Father's Name / Husband's Name	Holding No./Address	Category		Gender	Adhaar No.	Mob No.	Photo
						General/S.C./O.B. C./S.T.	Minority				
10	11	NON SLUM	PURNIMA DAS	MUKTI DAS	16/A/49 BIJOYNAGAR	GEN	NO	F	900986653420	7699874377	
11	11	NON SLUM	KANCHAN KUMAR GHOSH	PRADYUT KUMAR GHOSH	45/49 KALIBARI ROAD	GEN	NO	M	950498000089	9734868528	
12	11	NON SLUM	LAXMI ROOJ	BRINDABAN ROOJ	316/D JEMO BAZAR	GEN	NO	F	886580443120	8158860071	
13	11	NON SLUM	SIBABRATA MONDAL	LT. RAKHAKALI MONDAL	311/B, KALIBARI ROAD	GEN	NO	M	388799516007	8926334973	

CHAIRMAN
KANDI MUNICIPALITY

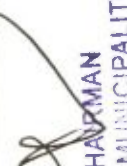
PMAY (HFA- 2019-20)

BENEFICIARY LIST OF KANDI MUNICIPALITY









Sl. No.	Ward No.	SLUM /Non Slum	Name of Beneficiary	Father's Name / Husband's Name	Holding No./Address	Category		Gender	Adhaar No.	Mob No.	Photo
						General/S.C./O.B. C./S.T	Minority				
1	12	NON SLUM	AMITINDRANARAYAN ROY CHOUDHURY	ARABENDRANARAYA N ROY CHOUDHURY	BAGDANGA	GENERAL	NO	M	666275110554		
2	12	NON SLUM	MITHU SK.	NINAI SK.	RAMSAGARPAR, BAGDANGA	GENERAL	Minority	M	402356762739	8617063691	
3	12	NON SLUM	ABDUL ALIM SK.	CHANDBARI SK.	JEMO BISWASPARA, BAGDANGA	GENERAL	Minority	M	679026300407	9732078972	
4	12	NON SLUM	MANSUR SK.	RAKHU SK.	RAMSAGARPAR, BAGDANGA	GENERAL	Minority	M	620625847684	8178445735	
5	12	NON SLUM	PRODIP KONAI	SUKUMAR KONAI	BAGDANGA	SC	NO	M	381879735118		
6	12	NON SLUM	MOUSUMI DEY	PRODIP DEY	BAGDANGA	GENERAL	NO	F	952971666113	7679151067	
7	12	NON SLUM	MAHADEB MONDAL	LT. SHIBARAM MONDAL	BAGDANGA	GENERAL	NO	M	776171934495	9476477297	
8	12	NON SLUM	SUJIT KUMAR SINHA	LT. PROFULLA KUMAR SINHA	BAGDANGA	GENERAL	NO	M	947674634538	9832215849	

Sl. No.	Ward No	SLUM/Non Slum	Name of Beneficiary	Father's Name / Husband's Name	Holding No./Address	Category		Gender	Adhaar No.	Mob No.	Photo
						General/S.C./O.B. C./S.T	Minority				
9	12	NON SLUM	ANSAR SK.	LT. AKKEL SK.	BISWASPARA, BAGDANGA	GENERAL	Minority	M	538879972718	9564768348	
10	12	NON SLUM	BAKKAR SK	KHANDU SK	NAMU BAGDANGA	G	Minority	M	221505993259		





CHAIRMAN
KANDI MUNICIPALITY

PMAY (HFA- 2019-20)

BENEFICIARY LIST OF KANDI MUNICIPALITY

Sl. No.	Ward No	SLUM /Non Slum	Name of Beneficiary	Father's Name / Husband's Name	Holding No./Address	Category		Gender	Adhaar No.	Mob No.	Photo
						General/S.C./O.B. C./S.T	Minority				
1	14	NON SLUM	RAM CHANDRA BASAK	L.T. BAIDYANATH BASAK	BANIKPARA	OBC	NO	M	305383070735	9933379534	
2	14	NON SLUM	TAPASI BAGDI	L.T. NANDA DULAL BAGDI	BANIKPARA	S.C.	NO	F	228139394286	7797091462	
3	14	NON SLUM	SUBHASHISH DUTTA	RAKHAHATI DUTTA	3648G/181, CHHATINAKANDI	GENERAL	NO	M	993195175243	8798076760	
4	14	NON SLUM	DIPAK UPADHYAY	L.T. SARADINDU UPADHYAY	CHHATINAKANDI BANIKPARA	GENERAL	NO	M	511650442285	9635315510	
5	14	NON SLUM	PARAMITA SEN	SARAJIT SEN	BANIKPARA	GENERAL	NO	F	402365567657	8250380041	
6	14	NON SLUM	JAYASHREE SINHA	KISHOR SINHA	CHHATINAKANDI	GENERAL	NO	F	387360275458	9093992412	
7	14	NON SLUM	ANISH KR DHAR	ATINDRA KR DHAR	BANIKPARA	GENERAL	NO	M	295786640016	6296691050	
8	14	NON SLUM	SUMAN SINHA	MANINDRA MOHAN SINHA	BANIKPARA	GENERAL	NO	M	921526942632	9830528213	









CHAIRMAN
KANDI MUNICIPALITY

Sl. No.	Ward No	SLUM /Non Slum	Name of Beneficiary	Father's Name / Husband's Name	Holding No./Address	Category		Gender	Adhaar No.	Mob No.	Photo
						General/S.C./O.B. C./S.T	Minority				
9	14	NON SLUM	SWARUP KR. SAHA	NIRMAL KR SAHA	BANIKPARA	S.C.	NO	M	271063847653	7548003971	
10	14	NON SLUM	PARITOSH MUKHERJEE	LT. KASHINATH MUKHERJEE	BANIKPARA	GENERAL	NO	M	758333459566	9749386173	
11	14	NON SLUM	GOUR CHANDRA PAUL	LT. SHISHIR KR. PAUL	BANIKPARA	GENERAL	NO	M	321017090662	9775428178	
12	14	NON SLUM	BIMAN BISWAS	BAIDYANATH BISWAS	BISWASPARA	OBC	NO	M	520325850536	8001912216	











CHAIRMAN
KANDI MUNICIPALITY

PMAY (HFA - 2019 20)

BENEFICIARY LIST OF KANDI MUNICIPALITY

Sl. No.	Ward No	SLUM /Non Slum	Name of Beneficiary	Father's Name / Husband's Name	Holding No./Address	Category		Gender	Adhaar No.	Mob No.	Photo
						General/S.C./O.B.C./S.T	Minority				
1	15	NON SLUM	SUMIT CHATTERJEE	LT. MANIK LAL CHATTERJEE	DADTALA MATH	GENERAL	NO	M	796105495191	9851262786	
2	15	NON SLUM	SAHADEB MANDAL	LT. BHARAT CHANDRA MANDAL	DADTALA MATH	GENERAL	NO	M	443406384433	8972114425	
3	15	NON SLUM	ABHIJIT DAS	APAN KUMAR DAS	RUPPUR	GENERAL	NO	M	496733438779	9332043542	
4	15	NON SLUM	RAMESH DAS	LT. TRIBHANGA DAS	RUPPUR DIGHIRPAR	GENERAL	NO	M	863791085390	9732965300	
5	15	NON SLUM	SANTWANA HAZRA	KANTU HAZRA	DADTALA MATH	SC	NO	F	839208631760	7718784383	
6	15	NON SLUM	UTPAL KUMAR DAS	SANTIMOY DAS	53/144/1, RUPPUR	OBC	NO	M	771160897402	9614053087	
7	15	NON SLUM	PRANAB MISTRI	BISWANATH MISTRI	RUPPUR	GENERAL	NO	M	733786590063	9734870675	
8	15	NON SLUM	KOUSHIK DAS	GOUTAM DAS	RUPPUR	GENERAL	NO	M	717898652505	7679814414	
9	15	NON SLUM	ANUP KUMAR DAS	DINABANDHU DAS	RUPPUR	GENERAL	NO	M	651374262191		

 CHAIRMAN
 KANDI MUNICIPALITY







Sl. No.	Ward No	SLUM /Non Slum	Name of Beneficiary	Father's Name / Husband's Name	Holding No./Address	Category		Gender	Adhaar No.	Mob No.	Photo
						General/S.C./O.B. C./S.T	Minority				
10	15	NON SLUM	DEB KUMAR DAS	ANANDA DAS	RUPPUR	GENERAL	NO	M	345099884286	8158975859	
11	15	NON SLUM	TARAK NATH ROY	ANIL KUMAR ROY	RUPPUR	GENERAL	NO	M	450197348376	9732548107	
12	15	NON SLUM	TARUN DAS	LT. SUSHIL KUMAR DAS	RUPPUR	GENERAL	NO	M	74841706872	6297499513	
13	15	NON SLUM	NOTON DEY	BISWANATH DEY	RUPPUR DIGHIRPAR	GENERAL	NO	M	633661648100	7001098094	
14	15	NON SLUM	SATINATH BHATTACHARJEE	BOYMKESH BHATTACHARJEE	RUPPUR	GENERAL	NO	M	469453893031	9775659054	
15	15	NON SLUM	UTPAL MUKHERJEE	KALISHANKAR MUKHERJEE	RUPPUR	GENERAL	NO	M	600205147193	9732947939	
16	15	NON SLUM	SUSANTA MUKHERJEE	KARTIC CHANDRA MUKHERJEE	RUPPUR	GENERAL	NO	M	300117522007	8167706108	
17	15	NON SLUM	JARINDAM ROY	NISHAKAR ROY	RUPPUR	GENERAL	NO	M	297220527823	9733587173	
18	15	NON SLUM	TANMOY ROYCHOWDHURY	LT RAMANI MOHON ROYCHOWDHURY	RUPPUR	GENERAL	NO	M	323656743449	8145253266	
19	15	NON SLUM	MANDIRA SAHA	UTTAM SAHA	RUPPUR DIGHIRPAR	GENERAL	NO	F	413617619582	9932265179	



CHAIRMAN
KANDI MUNICIPALITY

PMAY (HFA- 2019-20)

BENEFICIARY LIST OF KANDI MUNICIPALITY

Sl. No.	Ward No	SLUM /Non Slum	Name of Beneficiary	Father's Name / Husband's Name	Holding No./Address	Category		Gender	Adhaar No.	Mob No.	Photo
						General/S.C./O.B. C./S.T	Minority				
1	16	NON SLUM	LAXMI BANERIEE	HIRANMOY BANERJEE	BAGDANGA	GENERAL	NO	F	983198738634	7076863406	
2	16	NON SLUM	SONARUDDIN SK	NAIMUDDIN SK	BAGDANGA	GENERAL	YES	M	663537132510		
3	16	NON SLUM	NIL MADHAB DHAR	SITANGSHU DHAR	BAGDANGA	GENERAL	NO	M	607338951930		
4	16	NON SLUM	SAFEDA BIBI	HIRU SK	BAGDANGA	GENERAL	YES	F	786136839699		
5	16	NON SLUM	BRINDABAN DAS	JASODA NANDAN DAS	BAGDANGA	S.C.	NO	M	761234302560		
6	16	NON SLUM	SOURAV DAS	SHAKTIPADA DAS	BAGDANGA	S.C.	NO	M	60730454781		
7	16	NON SLUM	SHIB SANKAR DUTTA	DHIREN DUTTA	BAGDANGA	GENERAL	NO	M	636296688212		
8	16	NON SLUM	RENUPADA MONDAL	INDRA BHUSAN MONDAL	BAGDANGA	GENERAL	NO	M	777627643019		
9	16	NON SLUM	NABAKUMAR SAHA	LT. DHANANJOY SAHA	BAGDANGA	S.C.	NO	M	768298680358		



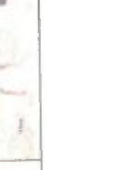





 CHAIRMAN
 KANDI MUNICIPALITY

Sl. No.	Ward No	SLUM /Non Slum	Name of Beneficiary	Father's Name / Husband's Name	Holding No./Address	Category		Gender	Adhaar No.	Mob No.	Photo
						General/S.C./O.B. C./S.T	Minority				
10	16	NON SLUM	SHIBNATH DUTTA	TARUN KUMAR DUTTA	BAGDANGA	GENERAL	NO	M	791479808788		
11	16	NON SLUM	PAROMITA MONDAL	SUREN MONDAL	BAGDANGA	GENERAL	NO	F	691823744036		
12	16	NON SLUM	SANTA SAHA	LT. BAMACHARAN SAHA	BAGDANGA	S.C.	NO	M	654255351824		
13	16	NON SLUM	BARKAT SK	SHUKU SJ	BAGDANGA	GENERAL	YES	M	624061613338		
14	16	NON SLUM	MEHER SK	PATU SK	BAGDANGA	GENERAL	YES	M	850090588076		
15	16	NON SLUM	KRISHNA RUJ	MAHADEB RUJ	BAGDANGA	GENERAL	NO	M	386746072775		

CHAIRMAN
KANDI MUNICIPALITY

PMAY (HFA- 2019-20)

BENEFICIARY LIST OF KANDI MUNICIPALITY







Sl. No.	Ward No	SLUM /Non Slum	Name of Beneficiary	Father's Name / Husband's Name	Holding No./Address	Category		Gender	Adhaar No.	Mob No.	Photo
						General/S.C./O.B.C./S.T	Minority				
1	17	NON SLUM	DHANANJOY DAS	LT NITAI DAS	N/117 NATUNHAT	GEN	NO	M	531593454106	8101810826	
2	17	NON SLUM	SUPRIYO CHATTARAJ	LT ANIL CHATTARAJ	4/C/12 RADHABAZAR	GEN	NO	M	562987519203	9382038695	
3	17	NON SLUM	USHA JHA	SAMBHU JHA	NEW SHYAMBAZAR	GENERAL	NO	F	748023995128	8972133075	
4	17	NON SLUM	RANJIT KUMAR DEY	LT RAMINARAYAN DEY	NEW NATUNHAT	GENERAL	NO	M	375162239603	9434639273	
5	17	NON SLUM	BISWAJIT SAHA	RANJIT KUMAR SAHA	73 NATUNHAT	GEN	NO	M	932829558102	9046635770	
6	17	NON SLUM	ACHINTYA DAS	LT BHOLANATH DAS	30/B/53 RADHABAZAR	OBC	NO	M	544052781629	9232664778	
7	17	NON SLUM	NISHIKANTA PAL	LATE NITAI CHANDRA PAL	26/11/1 SHYAMBAZER	GEN	NO	M	865840254767	7029240388	











CHAIRMAN
KANDI MUNICIPALITY

PMAY (HFA- 2019-20)

BENEFICIARY LIST OF KANDI MUNICIPALITY

Sl. No.	Ward No	SLUM /Non Slum	Name of Beneficiary	Father's Name / Husband's Name	Holding No./Address	Category		Gender	Adhaar No.	Mob No.	Photo
						General/S.C./O.B. C./S.T	Minority				
1	18	NON SLUM	GOUTAM MUKHERJEE	LT. MURARI MOHAN MUKHERJEE	321/A/2	GENERAL	NO	M	477100120644	9733924489	
2	18	NON SLUM	TAJEMOL SEKH	LT. JAMIDAR SEKH	320/B/1	OBC	YES	M	313568053036	8509125340	
3	18	NON SLUM	BISHAKHA MONDAL	LT. HARI MONDAL	157N	GENERAL	NO	F	981237414243	9564020328	
4	18	NON SLUM	MALA RAJAK	BRINDABAN RAJAK	157/A/2	S.C.	NO	F	708876285284	9563502211	
5	18	NON SLUM	MD. MUKTAR SEIKH	LT. SAKED SK	169/C/3	OBC	YES	M	788105551627	8145495421	
6	18	NON SLUM	SHEFALI BIBI	FULCHAND SK	177/A/2	OBC	YES	F	810815605660	7551015133	
7	18	NON SLUM	FARIDA BEGOM	PIARUL ISLAM	122/C/3	OBC	YES	F	585273779154	9732824484	

 CHAIRMAN
 KANDI MUNICIPALITY

Sl. No.	Ward No	SLUM /Non Slum	Name of Beneficiary	Father's Name / Husband's Name	Holding No./Address	Category		Gender	Adhaar No.	Mob No.	Photo
						General/S.C./O.B. C./S.T	Minority				
8	18	NON SLUM	RIJAK SK	LT. AMIDAR SK	237/A/1	OBC	YES	M	538819521740	9735269713	
9	18	NON SLUM	AMIR SEKH	SATTAR SEKH	268C/2	OBC	YES	M	849701833688	7797909998	
10	18	NON SLUM	DEBASHIS BANERJEE	LT. ADYAPADA BANERJEE	297/A/3	GENERAL	NO	M	368977491682	9775691360	
11	18	NON SLUM	BANSHI MONDAL	LT. TINKARI MONDAL	198/A/2	GENERAL	NO	M	993185762965	9734442688	
12	18	NON SLUM	BUDDHADEB MONDAL	SHYAM SUNDAR MONDAL	198/A/3	GENERAL	NO	M	564606008379	6295203419	
13	18	NON SLUM	ALAM SEKH	LT. MARFAT SEKH	198/A/1	OBC	YES	M	307714112107	8918048390	
14	18	NON SLUM	RAMJAN SEKH	LT. RUSTAM SEKH	198/B/2	OBC	YES	M	308613288837	9609474334	
15	18	NON SLUM	LUTFA BIBI	SAMSUDDIN SEKH	199 NEW	OBC	YES	F	958956585998	8509261471	

CHAIRMAN
KANDI MUNICIPALITY

Sl. No.	Ward No	SLUM /Non Slum	Name of Beneficiary	Father's Name / Husband's Name	Holding No./Address	Category		Gender	Adhaar No.	Mob No.	Photo
						General/S.C./O.B. C./S.T	Minority				
16	18	NON SLUM	HAMEDA BEAWA	MAHIRUDDIN SK	237N	OBC	YES	F	497031102384	7872082517	
17	18	NON SLUM	TAPATI DAS	LT. RASHMOHAN DAS	231/A/2	OBC	NO	M	411960534374	9475368238	
18	18	NON SLUM	PARESH MONDAL	LT. GOPAL MONDAL	231/A/1	GENERAL	NO	M	712436181126	9732525863	

CHAIRMAN
KANDI MUNICIPALITY