

51. MADHUPARA SLUM(A.G COLONY)	
1. Connectivity to City-wide Water Supply System	Partially connected
2. Connectivity to City-wide Strom-water Drainage Supply System	Partially connected
3. Connectivity to City-wide Sewerage System	No sewerage system
4. Whether the slum is prone to flooding due to rains	No
5. Frequency of garbage Disposal	Daily
6. Arrangement for Global Disposal	Municipal staff
7. Frequency of clearance open drains	Once in 2 days
8. Approach Road/Lane/Constructed Path to Slum	Motorable katcha
9. Distance from the nearest Motorable road	Less than 0.5 km
10. Internal Road	Non-motorable
11. Whether Street light facility is available in the Slum	Not adequate

52. DAKSHIN HARIA MUSLIM PARA & PADMA PALLY	
1. Connectivity to City-wide Water Supply System	Partially connected
2. Connectivity to City-wide Strom-water Drainage Supply System	Partially connected
3. Connectivity to City-wide Sewerage System	No sewerage system
4. Whether the slum is prone to flooding due to rains	No
5. Frequency of garbage Disposal	Daily
6. Arrangement for Global Disposal	Municipal staff
7. Frequency of clearance open drains	Once in 2 days
8. Approach Road/Lane/Constructed Path to Slum	Motorable katcha
9. Distance from the nearest Motorable road	Less than 0.5 km
10. Internal Road	Non-motorable
11. Whether Street light facility is available in the Slum	Not adequate

Status of Physical Infrastructure (In Non Slum)

1. 2NO. SUBHASH PALLY	
1. Connectivity to City-wide Water Supply System	Partially connected
2. Connectivity to City-wide Strom-water Drainage Supply System	Partially connected
3. Connectivity to City-wide Sewerage System	No sewerage system
4. Whether the slum is prone to flooding due to rains	No
5. Frequency of garbage Disposal	Daily
6. Arrangement for Global Disposal	Municipal staff
7. Frequency of clearance open drains	Once in 2 days
8. Approach Road/Lane/Constructed Path to Slum	Motorabble katcha
9. Distance from the nearest Motorable road	Less than 0.5 km
10. Internal Road	Non-motorable
11. Whether Street light facility is available in the Slum	Not adequate
2. SHIL PARA	
1. Connectivity to City-wide Water Supply System	Partially connected
2. Connectivity to City-wide Strom-water Drainage Supply System	Partially connected
3. Connectivity to City-wide Sewerage System	No sewerage system
4. Whether the slum is prone to flooding due to rains	No
5. Frequency of garbage Disposal	Daily
6. Arrangement for Global Disposal	Municipal staff
7. Frequency of clearance open drains	Once in 2 days
8. Approach Road/Lane/Constructed Path to Slum	Motorabble katcha
9. Distance from the nearest Motorable road	Less than 0.5 km
10. Internal Road	Non-motorable
11. Whether Street light facility is available in the Slum	Not adequate

3. KABIGURU ROAD	
1. Connectivity to City-wide Water Supply System	Partially connected
2. Connectivity to City-wide Strom-water Drainage Supply System	Partially connected
3. Connectivity to City-wide Sewerage System	No sewerage system
4. Whether the slum is prone to flooding due to rains	No
5. Frequency of garbage Disposal	Daily
6. Arrangement for Global Disposal	Municipal staff
7. Frequency of clearance open drains	Once in 2 days
8. Approach Road/Lane/Constructed Path to Slum	Motorable katcha
9. Distance from the nearest Motorable road	Less than 0.5 km
10. Internal Road	Non-motorable
11. Whether Street light facility is available in the Slum	Not adequate
4. JOYGACHI, SREEPUR PASHCHIM PARA	
1. Connectivity to City-wide Water Supply System	Partially connected
2. Connectivity to City-wide Strom-water Drainage Supply System	Partially connected
3. Connectivity to City-wide Sewerage System	No sewerage system
4. Whether the slum is prone to flooding due to rains	No
5. Frequency of garbage Disposal	Daily
6. Arrangement for Global Disposal	Municipal staff
7. Frequency of clearance open drains	Once in 2 days
8. Approach Road/Lane/Constructed Path to Slum	Motorable katcha
9. Distance from the nearest Motorable road	Less than 0.5 km
10. Internal Road	Non-motorable
11. Whether Street light facility is available in the Slum	Not adequate

5. DASPARA, PAL PARA COLONY, R.K.SARANI, SREENAGAR S.B. ROAD	
1. Connectivity to City-wide Water Supply System	Partially connected
2. Connectivity to City-wide Strom-water Drainage Supply System	Partially connected
3. Connectivity to City-wide Sewerage System	No sewerage system
4. Whether the slum is prone to flooding due to rains	No
5. Frequency of garbage Disposal	Daily
6. Arrangement for Global Disposal	Municipal staff
7. Frequency of clearance open drains	Once in 2 days
8. Approach Road/Lane/Constructed Path to Slum	Motorable katcha
9. Distance from the nearest Motorable road	Less than 0.5 km
10. Internal Road	Non-motorable
11. Whether Street light facility is available in the Slum	Not adequate
6. BARALIA ROAD, HIJAL PUKURIA	
1. Connectivity to City-wide Water Supply System	Partially connected
2. Connectivity to City-wide Strom-water Drainage Supply System	Partially connected
3. Connectivity to City-wide Sewerage System	No sewerage system
4. Whether the slum is prone to flooding due to rains	No
5. Frequency of garbage Disposal	Daily
6. Arrangement for Global Disposal	Municipal staff
7. Frequency of clearance open drains	Once in 2 days
8. Approach Road/Lane/Constructed Path to Slum	Motorable katcha
9. Distance from the nearest Motorable road	Less than 0.5 km
10. Internal Road	Non-motorable
11. Whether Street light facility is available in the Slum	Not adequate

7. VIDYASAGAR ROAD, MAHAMAYA

1. Connectivity to City-wide Water Supply System	Partially connected
2. Connectivity to City-wide Storm-water Drainage Supply System	Partially connected
3. Connectivity to City-wide Sewerage System	No sewerage system
4. Whether the slum is prone to flooding due to rains	No
5. Frequency of garbage Disposal	Daily
6. Arrangement for Global Disposal	Municipal staff
7. Frequency of clearance open drains	Once in 2 days
8. Approach Road/Lane/Constructed Path to Slum	Motorable katcha
9. Distance from the nearest Motorable road	Less than 0.5 km
10. Internal Road	Non-motorable
11. Whether Street light facility is available in the Slum	Not adequate

8. ARABINDA ROAD, NATUN GRAM

1. Connectivity to City-wide Water Supply System	Partially connected
2. Connectivity to City-wide Storm-water Drainage Supply System	Partially connected
3. Connectivity to City-wide Sewerage System	No sewerage system
4. Whether the slum is prone to flooding due to rains	No
5. Frequency of garbage Disposal	Daily
6. Arrangement for Global Disposal	Municipal staff
7. Frequency of clearance open drains	Once in 2 days
8. Approach Road/Lane/Constructed Path to Slum	Motorable katcha
9. Distance from the nearest Motorable road	Less than 0.5 km
10. Internal Road	Non-motorable
11. Whether Street light facility is available in the Slum	Not adequate

9. MANASHA PARA, PRAFULLA NAGAR

1. Connectivity to City-wide Water Supply System	Partially connected
2. Connectivity to City-wide Strom-water Drainage Supply System	Partially connected
3. Connectivity to City-wide Sewerage System	No sewerage system
4. Whether the slum is prone to flooding due to rains	No
5. Frequency of garbage Disposal	Daily
6. Arrangement for Global Disposal	Municipal staff
7. Frequency of clearance open drains	Once in 2 days
8. Approach Road/Lane/Constructed Path to Slum	Motorabble katcha
9. Distance from the nearest Motorable road	Less than 0.5 km
10. Internal Road	Non-motorable
11. Whether Street light facility is available in the Slum	Not adequate

10. MAHAMAYA ROAD, GOORBANGA ROAD, SUBHASH ROAD, ASIWANIDUTTA LANE

1. Connectivity to City-wide Water Supply System	Partially connected
2. Connectivity to City-wide Strom-water Drainage Supply System	Partially connected
3. Connectivity to City-wide Sewerage System	No sewerage system
4. Whether the slum is prone to flooding due to rains	No
5. Frequency of garbage Disposal	Daily
6. Arrangement for Global Disposal	Municipal staff
7. Frequency of clearance open drains	Once in 2 days
8. Approach Road/Lane/Constructed Path to Slum	Motorabble katcha
9. Distance from the nearest Motorable road	Less than 0.5 km
10. Internal Road	Non-motorable
11. Whether Street light facility is available in the Slum	Not adequate

11. BANIPUR P.G.B.T ROAD

1. Connectivity to City-wide Water Supply System	Partially connected
2. Connectivity to City-wide Storm-water Drainage Supply System	Partially connected
3. Connectivity to City-wide Sewerage System	No sewerage system
4. Whether the slum is prone to flooding due to rains	No
5. Frequency of garbage Disposal	Daily
6. Arrangement for Global Disposal	Municipal staff
7. Frequency of clearance open drains	Once in 2 days
8. Approach Road/Lane/Constructed Path to Slum	Motorable katcha
9. Distance from the nearest Motorable road	Less than 0.5 km
10. Internal Road	Non-motorable
11. Whether Street light facility is available in the Slum	Not adequate

HABRA MUNICIPALITY

PROMODE DASGUPTA SARANI, P.O.- HABRA,
NORTH 24 PARGANAS, PIN - 743263.

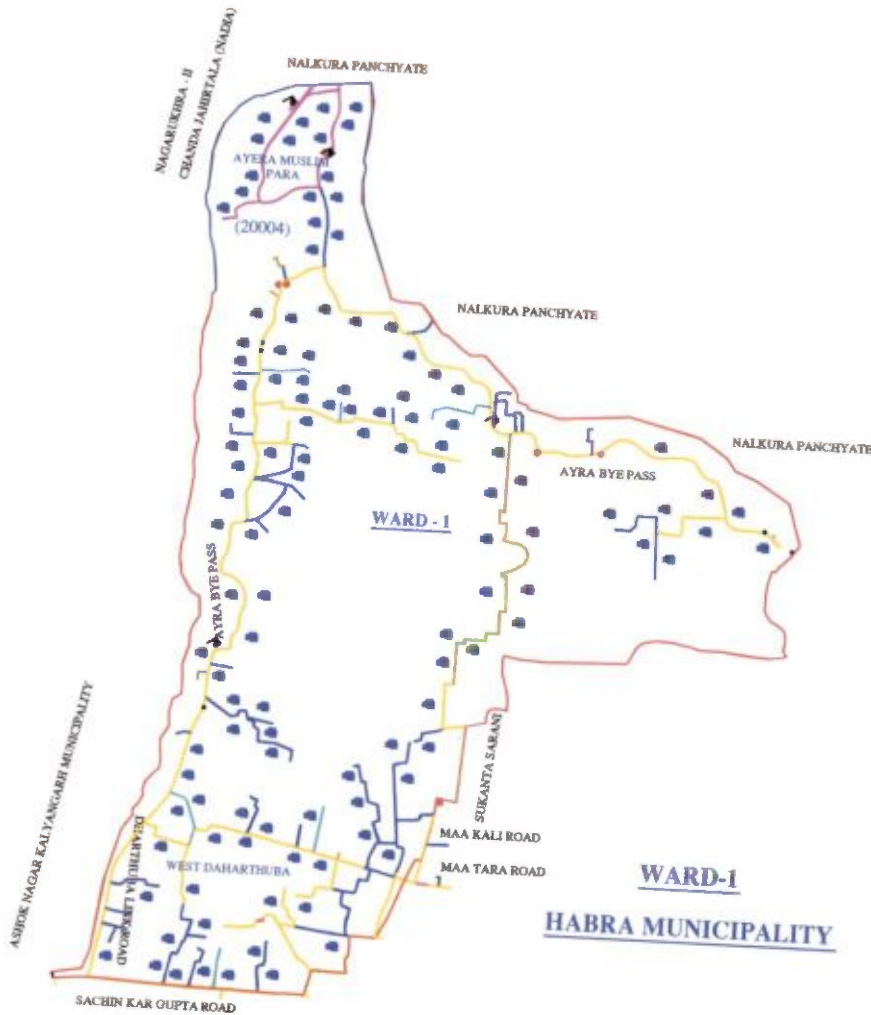

PROPOSED LAND USE			
AREA OF WARD : 2.410 Sq. kms.			
POPULATION : 8972 Nos.			
CLIENT : HABRA MUNICIPALITY			
LEGEND			
ITEMS	EXISTING	PROPOSED	
		QTY.	
DWELLINGHOUSE (NOS)	[Symbol]	163	
CONCRETE ROAD (Sq M)	[Symbol]	3236.55	
DRAIN (IN M)	[Symbol]	475.01	

[Signature]
Sub-Assistant Engineer
HABRA MUNICIPALITY

[Signature]
Administrator
HABRA MUNICIPALITY

HABRA MUNICIPALITY

PROMODE DASGUPTA SARANI,P.O.- HABRA,
NORTH 24 PARGANAS, PIN - 743263.

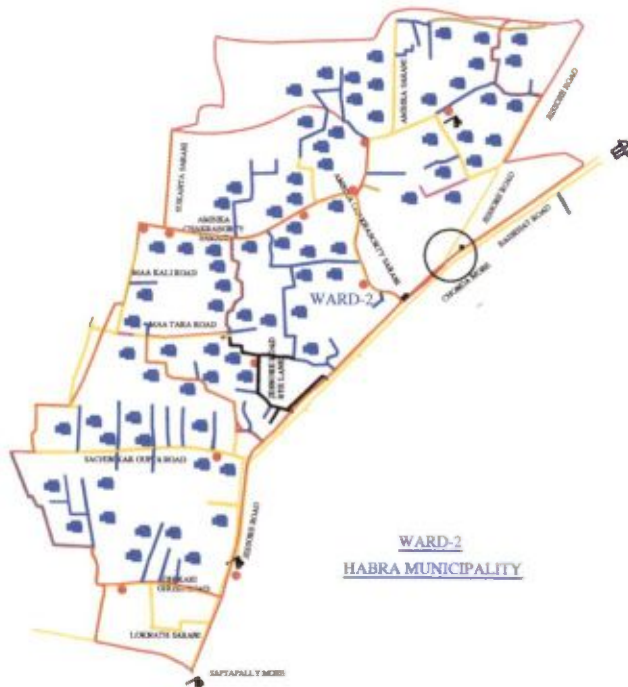

WARD-2
HABRA MUNICIPALITY

PROPOSED LAND USE			
AREA OF WARD : 0.840 Sq.kms.			
POPULATION : 4586 Nos.			
CLIENT : HABRA MUNICIPALITY			
LEGEND			
ITEMS	EXISTING	PROPOSED	
			QTY.
DWELLINGHOUSE (NOS)			96
CONCRETE ROAD (Sq.M)			2541.58
NOT TO SCALE			

(Signature)
Sub-Assistant Engineer
HABRA MUNICIPALITY

(Signature)
Administrator
HABRA MUNICIPALITY

HABRA MUNICIPALITY

PROMODE DASGUPTA SARANI,P.O.- HABRA,
NORTH 24 PARGANAS, PIN - 743263.

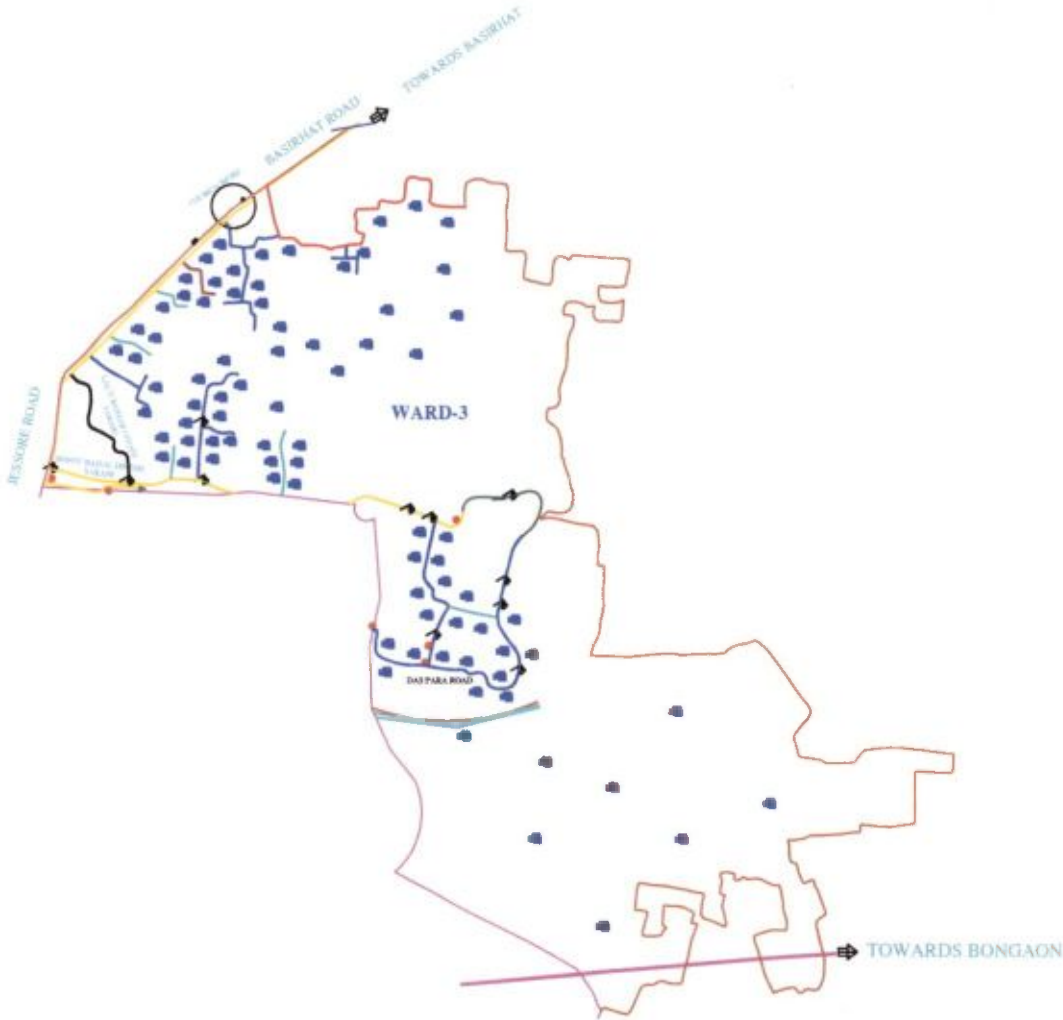

WARD - 3
HABRA MUNICIPALITY

PROPOSED LAND USE			
AREA OF WARD : 1.500 Sq.kms.			
POPULATION : 5946 Nos.			
CLIENT : HABRA MUNICIPALITY			
LEGEND			
ITEMS	EXISTING	PROPOSED	QTY.
		■	
DWELLINGHOUSE (NOS)		■	77
CONCRETE ROAD (Sq.M)	— — —	— — —	1019.28
DRAIN (IN M)		— — —	448.78
NOT TO SCALE			

(Signature)
Sub-Assistant Engineer
HABRA MUNICIPALITY

(Signature)
Administrator
HABRA MUNICIPALITY

HABRA MUNICIPALITY

PROMODE DASGUPTA SARANI, P.O.- HABRA,
NORTH 24 PARGANAS, PIN - 743263.



WARD - 4
HABRA MUNICIPALITY

PROPOSED LAND USE			
AREA OF WARD : 1.580 Sq.kms.			
POPULATION : 3231 Nos.			
CLIENT : HABRA MUNICIPALITY			
LEGEND			
ITEMS	EXISTING	PROPOSED	QTY.
			39
DRAIN (IN M)			454.61
NOT TO SCALE			

Sub-Assistant Engineer
HABRA MUNICIPALITY

Administrator
HABRA MUNICIPALITY

HABRA MUNICIPALITY

PROMODE DASGUPTA SARANI,P.O.- HABRA,
NORTH 24 PARGANAS, PIN - 743263.

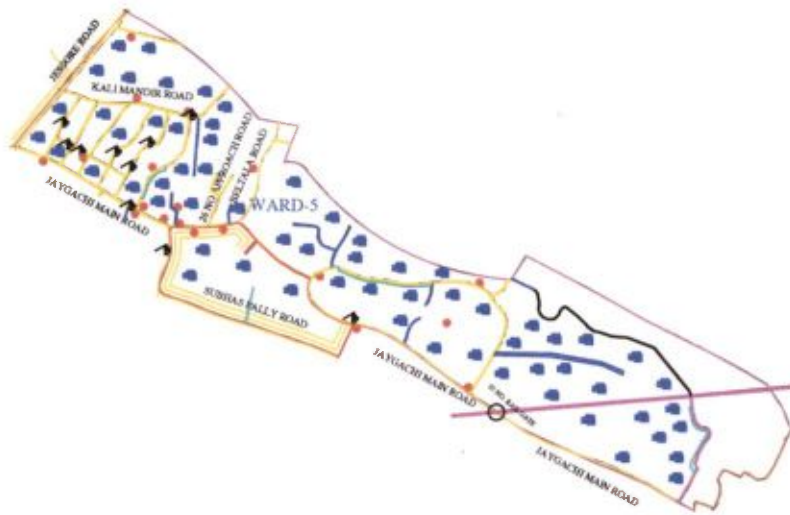

WARD - 5 HABRA MUNICIPALITY

PROPOSED LAND USE			
AREA OF WARD : 1.500 Sq.kms.			
POPULATION : 8214 Nos.			
CLIENT : HABRA MUNICIPALITY			
LEGEND			
ITEMS	EXISTING	PROPOSED	QTY.
		■	82
DWELLINGHOUSE (NOS)			
CONCRETE ROAD (Sq.M)	=	=	1628.20
DRAIN (IN M)		=	238.96
NOT TO SCALE			

 Sub-Assistant Engineer
 HABRA MUNICIPALITY

 Administrator
 HABRA MUNICIPALITY

HABRA MUNICIPALITY

PROMODE DASGUPTA SARANI, P.O.- HABRA,
NORTH 24 PARGANAS, PIN - 743263.

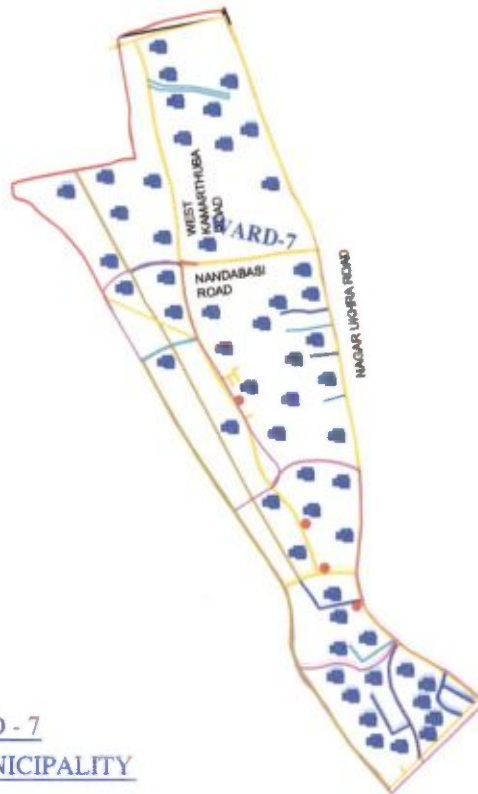

WARD - 7
HABRA MUNICIPALITY

PROPOSED LAND USE			
AREA OF WARD : 0.590 Sq.kms.			
POPULATION : 4557 Nos.			
CLIENT : HABRA MUNICIPALITY			
LEGEND			
ITEMS	EXISTING	PROPOSED	
			QTY.
DWELLINGHOUSE (NOS)			75
CONCRETE ROAD (Sq.M)			1389.93
DRAIN (IN M)			262.27
NOT TO SCALE			

Sub-Assistant Engineer
 HABRA MUNICIPALITY

Administrator
 HABRA MUNICIPALITY

HABRA MUNICIPALITY

PROMODE DASGUPTA SARANI, P.O.- HABRA,
NORTH 24 PARGANAS, PIN - 743263.



WARD - 8
HABRA MUNICIPALITY

PROPOSED LAND USE			
AREA OF WARD : 0.690 Sq.kms.			
POPULATION : 6074 Nos.			
CLIENT : HABRA MUNICIPALITY			
LEGEND			
ITEMS	EXISTING	PROPOSED	QTY.
			55
DWELLINGHOUSE (NOS)			
CONCRETE ROAD (Sq.M)			873.67
ROAD PROTECTION WALL (IN M)			108.28
NOT TO SCALE			

Sub-Assistant Engineer
HABRA MUNICIPALITY

Administrator
HABRA MUNICIPALITY

HABRA MUNICIPALITY

PROMODE DASGUPTA SARANI,P.O.- HABRA,
NORTH 24 PARGANAS, PIN - 743263.



WARD - 10
HABRA MUNICIPALITY

PROPOSED LAND USE			
AREA OF WARD : 0.940 Sq.kms.			
POPULATION : 4710 Nos.			
CLIENT : HABRA MUNICIPALITY			
LEGEND			
ITEMS	EXISTING	PROPOSED	
			QTY.
DWELLINGHOUSE (NOS)			63
CONCRETE ROAD (Sq.M)			416.98
ROAD PROTECTION WALL (IN M)			77.52
DRAIN (IN M)			367.18
NOT TO SCALE			

Sub-Assistant Engineer
HABRA MUNICIPALITY

Administrator
HABRA MUNICIPALITY

HABRA MUNICIPALITY

PROMODE DASGUPTA SARANI,P.O.- HABRA, NORTH 24 PARGANAS, PIN - 743263.

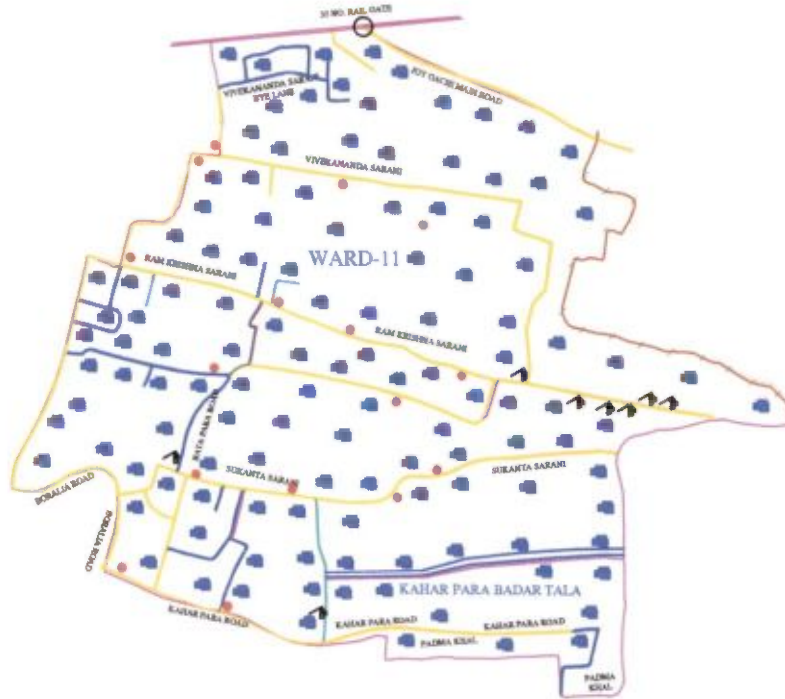

WARD - 11
HABRA MUNICIPALITY

PROPOSED LAND USE			
AREA OF WARD : 1.300 Sq.kms.			
POPULATION : 9024 Nos.			
CLIENT : HABRA MUNICIPALITY			
LEGEND			
ITEMS	EXISTING	PROPOSED	
			QTY.
DWELLINGHOUSE (NOS)			136
CONCRETE ROAD (Sq.M)			1800.29
DRAIN (IN M)			396.33
ROAD PROTECTION WALL (IN M)			167.34
NOT TO SCALE			

Sub-Assistant Engineer
 HABRA MUNICIPALITY

Administrator
 HABRA MUNICIPALITY

HABRA MUNICIPALITY

PROMODE DASGUPTA SARANI, P.O. - HABRA,
NORTH 24 PARGANAS, PIN - 743263.



WARD - 12
HABRA MUNICIPALITY

PROPOSED LAND USE			
AREA OF WARD : 0.780 Sq.kms.			
POPULATION : 6747 Nos.			
CLIENT : HABRA MUNICIPALITY			
LEGEND			
ITEMS	EXISTING	PROPOSED	QTY.
			109
DWELLINGHOUSE (NOS)			
CONCRETE ROAD (Sq.M)			577.15
DRAIN (IN M)			381.17
ROAD PROTECTION WALL (IN M)			268.24
NOT TO SCALE			

Sub-Assistant Engineer
HABRA MUNICIPALITY

Administrator
HABRA MUNICIPALITY

HABRA MUNICIPALITY

PROMODE DASGUPTA SARANI,P.O.- HABRA,
NORTH 24 PARGANAS, PIN - 743263.



WARD - 13
HABRA MUNICIPALITY

PROPOSED LAND USE			
AREA OF WARD : 0.340 Sq.kms.			
POPULATION : 5482 Nos.			
CLIENT : HABRA MUNICIPALITY			
LEGEND			
ITEMS	EXISTING	PROPOSED	QTY.
DWELLINGHOUSE (NOS)			38
CONCRETE ROAD (Sq.M)			251.51
DRAIN (IN M)			110.74
ROAD PROTECTION WALL (IN M)			93.51
NOT TO SCALE			

Sub-Assistant Engineer
HABRA MUNICIPALITY

Administrator
HABRA MUNICIPALITY

HABRA MUNICIPALITY

PROMODE DASGUPTA SARANI, P.O. - HABRA,
NORTH 24 PARGANAS, PIN - 743263.

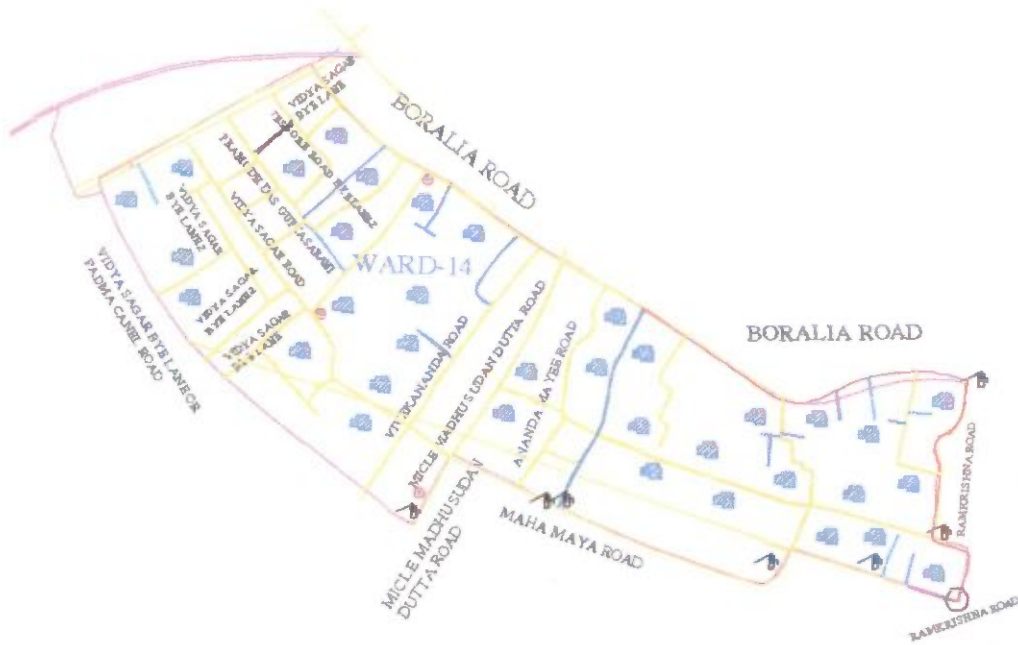

WARD - 14

HABRA MUNICIPALITY

PROPOSED LAND USE			
AREA OF WARD : 0.490 Sq.kms			
POPULATION : 6008 Nos			
CLIENT : HABRA MUNICIPALITY			
LEGEND			
ITEMS	EXISTING	PROPOSED	QTY
DWELLINGHOUSE (NOS)			32
CONCRETE ROAD (Sq.M)			508.32
DRAIN (INM)			149.20
NOT TO SCALE			

Sub-Assistant Engineer
 HABRA MUNICIPALITY

Administrator
 HABRA MUNICIPALITY

HABRA MUNICIPALITY

PROMODE DASGUPTA SARANI, P.O. - HABRA,
NORTH 24 PARGANAS, PIN - 743263.



WARD - 15

HABRA MUNICIPALITY

PROPOSED LAND USE			
AREA OF WARD : 0.580 Sq.kms			
POPULATION : 6599 Nos			
CLIENT : HABRA MUNICIPALITY			
LEGEND			
ITEMS	EXISTING	PROPOSED	QTY.
DWELLINGHOUSE (NOS)			74
CONCRETE ROAD (Sq.M)			979.57
DRAIN (IN M)			86.26
ROAD PROTECTION WALL (IN M)			145.68
NOT TO SCALE			

(Signature)
Sub-Assistant Engineer
HABRA MUNICIPALITY

(Signature)
Administrator
HABRA MUNICIPALITY

HABRA MUNICIPALITY

PROMODE DASGUPTA SARANI, P.O. - HABRA,
NORTH 24 PARGANAS, PIN - 743263.



WARD - 16

HABRA MUNICIPALITY

PROPOSED LAND USE

AREA OF WARD : 0.690 Sq.kms.

POPULATION : 4763 Nos.

CLIENT : HABRA MUNICIPALITY

LEGEND

ITEMS	EXISTING	PROPOSED	
			QTY.
DWELLINGHOUSE (NOS)			49
CONCRETE ROAD (Sq.M)			259.450
DRAIN (IN M)			114.240
ROAD PROTECTION WALL (IN M)			144.700

NOT TO SCALE

Sub-Assistant Engineer
HABRA MUNICIPALITY

Administrator
HABRA MUNICIPALITY

HABRA MUNICIPALITY

PROMODE DASGUPTA SARANI P.O. - HABRA,
NORTH 24 PARGANAS, PIN - 743263.



WARD-17
HABRA MUNICIPALITY

PROPOSED LAND USE			
AREA OF WARD : 0.760 Sq.kms			
POPULATION : 7017 Nos			
CLIENT : HABRA MUNICIPALITY			
LEGEND			
ITEMS	EXISTING	PROPOSED	
		[Symbol]	QTY
DWELLINGHOUSE (NOS)		[Symbol]	92
CONCRETE ROAD (Sq.M)	[Symbol]	[Symbol]	974.270
DRAIN (IN M)		[Symbol]	107.240
ROAD PROTECTION WALL (IN M)		[Symbol]	226.240
NOT TO SCALE			

[Signature]
Sub-Assistant Engineer
HABRA MUNICIPALITY

[Signature]
Administrator
HABRA MUNICIPALITY

HABRA MUNICIPALITY

PROMODE DASGUPTA SARANI, P.O. - HABRA,
NORTH 24 PARGANAS, PIN - 743263.



WARD - 19
HABRA MUNICIPALITY

PROPOSED LAND USE			
AREA OF WARD : 0.290 Sq.kms.			
POPULATION : 6563 Nos.			
CLIENT : HABRA MUNICIPALITY			
LEGEND			
ITEMS	EXISTING	PROPOSED	
			QTY.
DWELLINGHOUSE (NOS)			106
CONCRETE ROAD (Sq.M)			2806 330
NOT TO SCALE			

Sub-Assistant Engineer
 HABRA MUNICIPALITY

Administrator
 HABRA MUNICIPALITY

HABRA MUNICIPALITY

PROMODE DASGUPTA SARANI, P.O. - HABRA,
NORTH 24 PARGANAS, PIN - 743263.

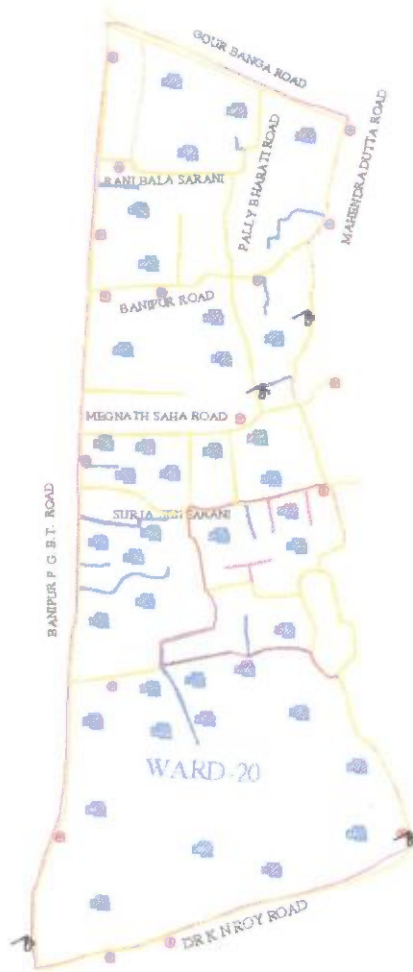

WARD - 20
HABRA MUNICIPALITY

PROPOSED LAND USE			
AREA OF WARD : 0.370 Sq kms			
POPULATION : 3766 Nos			
CLIENT : HABRA MUNICIPALITY			
LEGEND			
ITEMS	EXISTING	PROPOSED	QTY
			30
DWELLINGHOUSE (NCS)			
CONCRETE ROAD (Sq.M)			158.850
ROAD PROTECTION WALL (INM)			118.120
NOT TO SCALE			

Sub-Assistant Engineer
HABRA MUNICIPALITY

Administrator
HABRA MUNICIPALITY

HABRA MUNICIPALITY

PROMODE DASGUPTA SARANI.P.O.- HABRA,
NORTH 24 PARGANAS, PIN - 743263.



WARD - 22

HABRA MUNICIPALITY

PROPOSED LAND USE

AREA OF WARD : 0.110 Sq.kms

POPULATION : 5943 Nos

CLIENT : HABRA MUNICIPALITY

LEGEND

ITEMS	EXISTING	PROPOSED	
			QTY.
DWELLINGHOUSE (NOS)			73
DRAIN (IN.M) [450X600]		====	297.830
DRAIN (IN.M) [600X900]		=====	110.070
ROAD PROTECTION WALL (IN.M)		-----	71.860
CONCRETE ROAD (IN Sq.m)		=====	289.900

NOT TO SCALE

Sub-Assistant Engineer
HABRA MUNICIPALITY

Administrator
HABRA MUNICIPALITY

HABRA MUNICIPALITY

PROMODE DASGUPTA SARANI, P.O.- HABRA,
NORTH 24 PARGANAS, PIN - 743263.

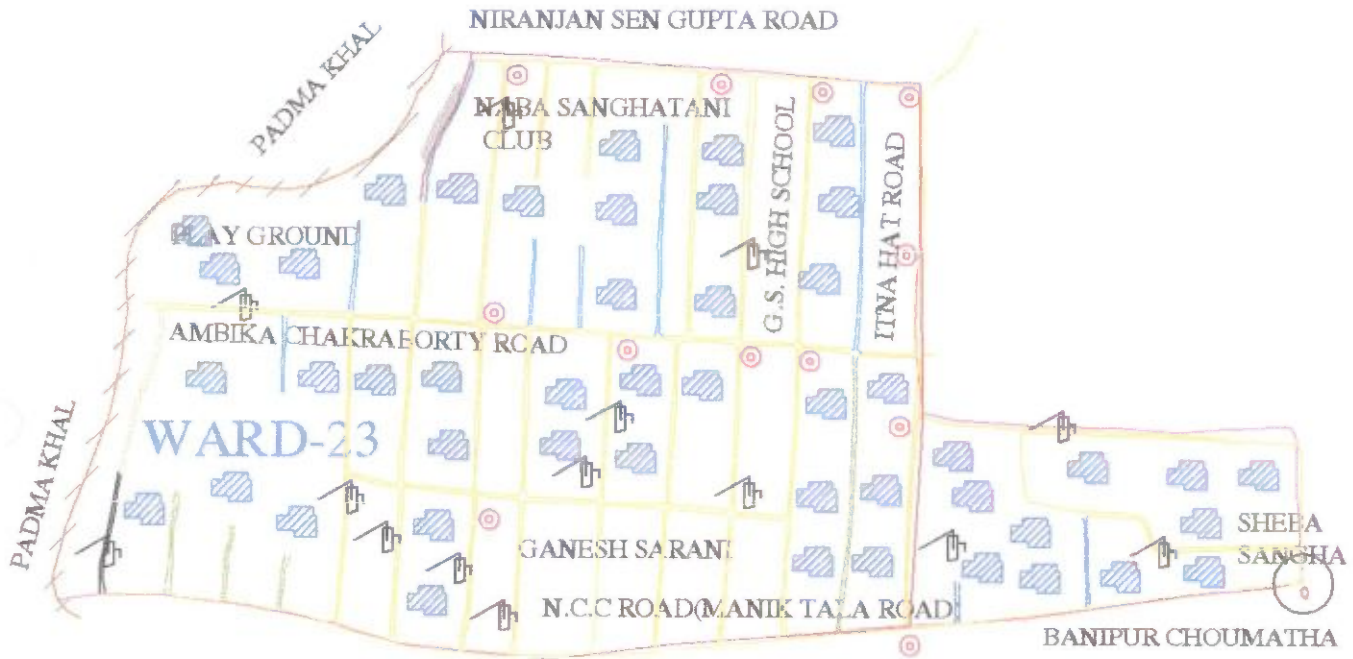

WARD - 23

HABRA MUNICIPALITY

PROPOSED LAND USE			
AREA OF WARD : 0.320 Sq.kms.			
POPULATION : 4275 Nos.			
CLIENT : HABRA MUNICIPALITY			
LEGEND			
ITEMS	EXISTING	PROPOSED	QTY.
			132
DWELLINGHOUSE (NOS)			132
DRAIN (IN.M) [450X600]			615.470
DRAIN (IN.M) [600X900]			398.060
NOT TO SCALE			

(Signature)
Sub-Assistant Engineer
HABRA MUNICIPALITY

(Signature)
Administrator
HABRA MUNICIPALITY

HABRA MUNICIPALITY

PROMODE DASGUPTA SARANI, P.O. - HABRA,
NORTH 24 PARGANAS, PIN - 743263.



WARD - 24
HABRA MUNICIPALITY

PROPOSED LAND USE

AREA OF WARD : 1.580 Sq.kms.

POPULATION : 5471 Nos.

CLIENT : HABRA MUNICIPALITY

LEGEND

ITEMS	EXISTING	PROPOSED	
			QTY.
DWELLINGHOUSE (NOS)			126
DRAIN (IN.M) [450X600]			367.180
ROAD PROTECTION WALL (IN M)			465.110

NOT TO SCALE

(Signature)
Sub-Assistant Engineer
HABRA MUNICIPALITY

(Signature)
Administrator
HABRA MUNICIPALITY

DRAWING &
ESTIMATES

WORK & COST SUMMARY FOR DEVELOPMENT OF VARIOUS SLUMS & NON SLUM IN HABRA MUNICIPALITY FOR THE YEAR 2019-2020

Sl. No	WARD NO.	D.U. No.	UNIT COST (LACS)	Total Cost (In Lack)	C.C. Road (Sq.Mtr.)	Cost (Sq.Mtr. In Rs.)	Total Cost (In Lack)	Road Protection Wall (In Mtr.)	Cost / Mtr. In Rs.	Total Cost (In Lack)	Drain(450x600) (Mtr.)	Cost (450x600) (Rs.)	Total Cost (In Lack)	Drain(600x900) (Mtr.)	Cost / Mtr. (In Rs.)	Total Cost (In Lack)	Total Infrastructure Cost (In lack)	Grand Total (In Lack)
1	1	163	3.68	599.84	3236.55	1390.00	44.9880				475.01	3157.00	14.9960			14.9960	59.984	659.82
2	2	96	3.68	353.28	2541.58	1390.00	35.3280										35.328	388.61
3	3	77	3.68	283.36	1019.28	1390.00	14.1680				448.78	3157.00	14.1680			14.1680	28.336	311.70
4	4	39	3.68	143.52							454.61	3157.00	14.352			14.352	14.352	157.872
5	5	82	3.68	301.76	1628.20	1390.00	22.6320				238.96	3157.00	7.5440			7.5440	30.176	331.94
6	6	69	3.68	253.92	913.38	1390.00	12.6960	169.80	7477.00	12.6960							25.392	279.31
7	7	75	3.68	276.00	1389.93	1390.00	19.320				262.27	3157.00	8.28			8.28	27.600	303.60
8	8	55	3.68	202.40	873.67	1390.00	12.1440	108.28	7477.00	8.0960							20.240	222.64
9	9	64	3.68	235.52	847.19	1390.00	11.7760	78.75	7477.00	5.8880	186.51	3157.00	5.8880			5.8880	23.552	259.07
10	10	63	3.68	231.84	416.98	1390.00	5.7960	77.52	7477.00	5.7960	367.18	3157.00	11.5920			11.5920	23.184	255.02
11	11	136	3.68	500.48	1800.29	1390.00	25.0240	167.34	7477.00	12.5120	396.33	3157.00	12.5120			12.5120	50.048	550.53
12	12	109	3.68	401.12	577.15	1390.00	8.0224	268.24	7477.00	20.0560	381.17	3157.00	12.0336			12.0336	40.112	441.23
13	13	38	3.68	139.84	251.51	1390.00	3.4960	93.51	7477.00	6.9920	110.74	3157.00	3.4960			3.4960	13.984	153.82
14	14	32	3.68	117.76	508.32	1390.00	7.07				149.20	3157.00	4.7104			4.7104	11.776	129.54
15	15	74	3.68	272.32	979.57	1390.00	13.6160	145.68	7477.00	10.8928	86.26	3157.00	2.7232			2.7232	27.232	299.55
16	16	49	3.68	180.32	259.45	1390.00	3.6064	144.70	7477.00	10.8192	114.24	3157.00	3.6064			3.6064	18.032	198.35
17	17	92	3.68	338.56	974.27	1390.00	13.5424	226.40	7477.00	16.9280	107.24	3157.00	3.3856			3.3856	33.856	372.42

 Sub-Assistant Engineer
 HABRA MUNICIPALITY

 Administrator
 HABRA MUNICIPALITY

WORK & COST SUMMARY FOR DEVELOPMENT OF VARIOUS SLUMS & NON SLUM IN HABRA MUNICIPALITY FOR THE YEAR 2019-2020

Sl. No	WARD NO.	D.Us No.	UNIT COST (LACK)	Total Cost (In Lack)	C.C.Road (Sq.Mtr.)	Cost /Sq.Mtr. in Rs.	Total Cost (In Lack)	Road Protection Wall (in Mtr.)	Cost / Mtr. in Rs.	Total Cost (In Lack)	Drain(450x600) (Mtr.)	Cost/ Mtr. in Rs.	Drain(600x900) (Mtr.)	Cost/ Mtr. in Rs.	Total Cost (In Lack)	Total Infrastructure Cost (in lack)	Grand Total (In Lack)
18	18	150	3.68	552.00	1985.61	1390.00	27.600			11.0400	349.70	7322.00	226.17	7322.00	16.5600	55.200	607.20
19	19	106	3.68	390.08	2806.33	1390.00	39.008									39.008	429.09
20	20	30	3.68	110.40	158.85	1390.00	2.2080	118.12	7477.00	8.8320						11.040	121.44
21	21	56	3.68	206.08				41.34	7477.00	3.0912	130.55	7322.00	182.94	7322.00	13.3952	20.608	226.69
22	22	73	3.68	268.64	289.90	1390.00	4.0296	71.86	7477.00	5.3728	297.83	7322.00	110.07	7322.00	8.0592	26.864	295.50
23	23	132	3.68	485.76							615.47	7322.00	398.06	7322.00	29.1456	48.576	534.34
24	24	126	3.68	463.68				465.11	7477.00	34.7760	367.18	7322.00	11.5920	7322.00	46.368	510.05	
		Total=		7308.48	23488.01		326.07	2176.648		162.75	5539.233		917.236		67.160	730.848	8039.33

 Sub-Assistant Engineer
 HABRA MUNICIPALITY

 Administrator
 HABRA MUNICIPALITY

DETAILED ESTIMATE FOR THE CONSTRUCTION OF SINGLE UNIT DWELLING HOUSE

Pradhan Mantri Awas Yojana Housing For All (Urban)

Total Covered Area- 32.18 sq.m (With Electrical Works)

Referance of Schedule of Rates : PWD (W.B.), Schedule of Rates Building & Sanitary w.e.f-01.07.2014 & Corrigenda (

Kolkata /24 Pgs (N & S)/ Kalyani Sub Div.)

Floor Area 25.37 sqm

SL No.	Description of Works	Quantity	Unit	Rate (Rs.)	Amount (Rs.)
1	Earthwork in excavation in foundation trenches or drains, in all sorts of soil (including mixed soil but excluding laterite or sandstone) including removing spreading or stacking the spoils within a lead of 75 m as directed including trimming the sides of trenches, levelling, dressing and ramming the bottom, bailing out water etc. as required complete. a) Depth of excavation not exceeding 1500mm . SOR, PWD, P-1, I -2 a	13.000	%cu.m	12047.00	1566.11
2	Earth work in filling in foundation trenches or plinth with good earth in layers not exceeding 150 mm. including watering and ramming etc. layer by layer complete.(Payment to be made on the basis of measurement of finished quantity of work) a) With earth obtained from excavation of foundation. SOR, PWD, P-1, T/3 a	11.120	%cu.m	7831.00	870.81
3	Supplying Laying Polithin Sheets etc. SOR, PWD, P-45, T - 13	22.000	sqm	25.00	550.00
4	Cement concrete with graded Stone ballast (40 mm.) excluding shuttering.a) In ground floor and foundation.6 : 3 : 1 proportion Pakur variety SOR, PWD, Page 24 : Item -10 a	3.500	cu.m.	5823.00	20380.50
5	25 mm. thick damp proof with cement concrete (4:2:1) (with graded stone aggregate 10 mm. Normal size) and painting the top surface with a coat of bitumen using 1.7 kg. per sq.m. including heating the bitumen and cost and carriage of all materials complete. SOR, PWD, P-45, T-12	6.810	sqm,	297.00	2022.57
6	Brick work with 1st class bricks in cement mortar (6:1) a) In foundation and plinth. b) In super structure SOR, PWD, P-29, T -22(a), (b)	10.430 15.240	cum cum	5719.00 5943.00	59649.17 90571.32
7	125mm thick brick work with 1st. class bricks in cement mortar (4:1). a) In ground floor SOR, PWD, P-73, I -29	23.220	sq.m.	783.00	18181.26
8	Ordinary Cement concrete (mix 1:1.5:3) with graded stone chips (20 mm nominal size) excluding shuttering and reinforcement if any, in ground floor as per relevant IS codes. (i) Pakur Variety SOR, PWD, P-14, T -7(i)	3.940	cu.m.	6851.66	26995.54
9	Reinforcements for reinforced concrete work in all sorts of structures including distribution bars, stirrups, binders etc. including supply of rods, initial straightening and removal of loose rust (if necessary), cutting to requisite length, hooking and bending to correct shape, placing in proper position and binding with 16G black annealed wire at every inter-section. complete as per drawing and direction. (a) For works in foundation, basement and upto roof of ground floor / upto 4m. (i) Tor steel/Mild steel. SOR, PWD, P-27, T -15(i)	0.309	MT	60705.93	18775.74

SL No.	Description of Works	Quantity	Unit	Rate (Rs.)	Amount (Rs.)
10	Hire and labour charges for shuttering with centreing and necessary staging upto 4 m. using approved stout props and thick hard wood planks of approved thickness with required bracing for concrete slabs, beams, columns, lintels curved or straight including fitting, fixing and striking out after completion of works. (upto roof of ground floor). (When the height of a particular floor is more than 4 m. the equivalent floor ht. shall be taken as 4 m. and extra for works beyond the initial 4 m. ht. shall be allowed under 12(e) for every 4 m. or part thereof.) SOR, PWD, P-66, T -12(a) 25 mm. to 30 mm. thick wooden shuttering as per decision & direction of Engineer-in-charge. Ground Floor	37.063	M ²	360.00	13342.68
11	Plaster (to wall, floor, ceiling etc.) with sand and cement mortar including rounding off or chamfering corners as directed and raking out joints or roughening of concrete surface, including throating, nosing and drip course where necessary . In ground floor. A) With 6:1 cement mortar. a) Inside wall 20 mm thick plaster SOR, PWD, P-151, T -2 (i)(b) b) Out side Wall, 15mm th. SOR, PWD, P-151, I -2 (i)(c) B)10mm th ceiling plaster (4:1) SOR, PWD, P-151, I -2 (i)(c)	116.940	sq.m.	181.00	21166.14
		111.950	sq.m.	156.00	17464.20
		23.330	sq.m.	140.00	3266.20
2	Neat cement punning about 1.5mm thick in wall, dado, window, sills, floor, drain etc. SOR, PWD, P-152, I -8	26.700	sq.m.	38.00	1014.60
13	Artificial stone in floor,dado, staircase etc. with cement concrete (4:2:1) with stone chips laid in panels as directed with topping made with ordinary or white cement (as necessary) and marble dust in proportion (2:1) including smooth finishing and rounding off corners and including application of cement slurry before flooring works, using cement @ 1.75 kg./sq.m. all complete including all materials and labour. In ground floor. 3 mm. thick topping (High polishing grinding on this item is not permitted) with ordinary cement. 20mm thick SOR, PWD, P-40, I -3 (i)	26.490	sq.m.	265.00	7019.85
14	Supplying, fitting & fixing MS clamp for fixing door and window frame made of flat bent bar, end bifurcated, fixed in cement concrete with stone chips (4:2:1)a fitted and fixed omplete as per direction. 40mm x 6mm x 125 mm length. (Cost of cement concrete will be paid separately) SOR, PWD, P-90, I -18 (c)	34	each	22.00	748.00
5	Wood work in door and window frame fitted and fixed complete including a protective coat of painting at the contact surface of the frame other Local wood SOR, PWD, P-85, T -1(i)	0.213	cu.m.	#####	9834.42
16	Panel Shutter of door & Window (each Panal Consisting Of single Plan without Join) 25 mm thick shutter with 12 mm thick Panal of size 30 to 45 cm. Other Local wood SOR, PWD, P-105, I -84 (iv)c	8.520	sq.m.	1567.00	13350.84
17	Iron butt hinges of approved quality fitted and fixed with steel screws, with ISI mark. a)75mm x 47mm x 1.70mm SOR, PWD, P-91, T -20(iv)	32.000	each	34.00	1088.00
18	Iron Socket Bolt of approved quality fitted and fixed complete. i) 150 mm long x 10 mm dia SOR, PWD P-93, I-25,c	11.000	each	71.00	781.00
19	White washing including cleaning and smoothening surface thoroughly (5 parts of stone lime and 1 part of shell lime should be used in the finishing coat). Two Coats SOR, PWD, P-155, I -3 (b)	124.960	%sq.m	1887.00	2358.00
20	Colour washing with ella with a coat of white wash priming including cleaning and smoothening surface thoroughly external surface One Coat SOR, PWD, P-155, I - 4(ii)(a)	100.560	%sq.m	1514.00	1522.48

SL No.	Description of Works	Quantity	Unit	Rate (Rs.)	Amount (Rs.)
21	Priming one coat on timber, plastered or on steel or other metal surface with synthetic enamel/oil bound primer of approved quality including smoothening surfaces by sand papering etc. 1) On timber surface SOR, PWD, P - 162, I - 7(a) 2) On Steel Surface SOR, PWD, P - 162, I - 7(b)	21.690 2.700	sq.m. sq.m.	41.00 31.00	889.29 83.70
22	Painting with best quality synthetic enamel paint of approved make and brand including smoothening surface by sand papering etc. including using of approved putty etc. on the surface, if necessary : With sinner gloss (hi-gloss)-With any shade except white a) On timber or plastered surface Two Coats b) On Steel surface Two Coats SOR, PWD, P - 162, - 8A(aii),(bii)	21.690 2.700	sq.m. sq.m.	89.00 86.00	1930.41 232.20
23	Iron hasp bolt of approved quality fitted and fixed complete (oxidised) with 16 mm dia with center bolt and round fitting. 300 mm long SOR, PWD, P-93, I - 27c	2.000	each	193.00	386.00
24	Precast piered concrete jally work as per design and manufacture's specification including moulding etc. with stone chips and necessary reinforcement shuttering complete including fitting, fixing in position in all floors. (a) 37.5 mm th. panels Cement & steel required for this item will not be issued by deptt. SOR, PWD, P-32, I - 38 (b)	1.690	sq.m.	351.00	593.19
25	Supplying, fitting and fixing UPVC down pipes A type and fittings conforming to IS 13592-1992 with necessary clamps nails including making holes in walls, etc. and cutting trenches in any soil, through masonry concrete structure etc. if necessary and mending good damages including jointing with jointing materials (Spun yarn, valamoid / bitumen / M. seal etc.) complete. SOR, PWD, P173, I - 21 A (ii), C(ii), D(ii) i) UPVC Pipe 110 mm dia ii) UPVC Bend 87.5 degree 110 mm dia iii) UPVC Shoe 110 mm	3.000 2.000 1.000	Mtr. each each	291.00 162.00 128.00	873.00 324.00 128.00
26	M.S.or W.I. Ornamental grill of approved design joints continuously welded with M.S, W.I. Flats and bars of windows, railing etc. fitted and fixed with necessary screws and lugs in ground floor. Grill weighing 10 kg/sq m to 16 kg/m ² SOR, PWD, P - 76, I - 10 (i) (2.70sam @ 10.5ka per sam = 28.35 ka)	0.284	Qntl	8247.00	2342.15
27	Shallow water closet Indian pattern(I.P.W.C.) of approved make in white vitreous chinaware supplied, fitted and fixed in position (excluding cost of concrete for fixing). 450 mm long SOR, PWD, (Sanitary) P - 65, I - 1 (iii)	1.000	each	1062.00	1062.00
28	Foot rest for water closet of size 275 mm X 125 mm with Artificial stone(4:2:1) with 6 mm stone chips and chequered including adding colour as necessary. SOR, PWD, (Sanitary) P - 66, I - 9	1.000	Pair	70.00	70.00
29	Supplying, fitting and fixing cast iron 'P' or 'S' trap conforming to I.S. 3989 / 1970 and 1729 / 1964 including lead caulked joints and painting two coats to the exposed surface. S Trap 100 mm SOR, PWD, (Sanitary) P - 54, I - 14(B-iii)	1.000	each	923.00	923.00
30	Supplying, fitting fixing CI Round Gratings 150mm dia SOR, PWD, (Sanitary) P - 55, I - 18(ii)	1.000	Each	100.00	100.00

Sl.No	Item of works	Unit	Rate	Quantity	Amount
6	Supplying Delivery & instalation on wall of 30/32 amp DP MCBof Havel's make with enclosed box along with all its necessary 1 connection complete.(Anchor)	nos	808.00	2	1616.00
7	Earthing in soft soil with 50 mm dia GI pipe (TATA make Medium) 3.64 mm th. X 3.04 Mtr long and 1 x 4 SWG GI (hot dip) wire (4 m long) 13 mmdia x 80 mm long GI bolts, double nuts, double washer including S & F 15 mm dia GI protection (1 mtr long) to be filled with bitumen partlyunder the ground level & partly above GL driven to an average depth of 3.65 m below the GL & restoring surface duly rammed.	each	1715.00	1	1715.00
8	Connecting the equipment to earth BUSbar inclusive S&F 10 SWG (Hot Dip) GI wire on wall /floor with a staples buried inside wall /floor as required & making connection to equipments with bolt, nut, washer, cable lugs etc. as required & mending good damages.	M	6.00	5	30.00
			TOTAL		17858.00
Rupees Thirteen Thousand Eight Hundred Seventy Eight Only					17858.00



 Sub-Assistant Engineer
 HABRA MUNICIPALITY

 Administrator
 HABRA MUNICIPALITY

**Cost Estimate for 2 Nos Leach Pit for single unit Dwelling Unit
P.W.D Schedule of Rates effect from 1st July 2014**

(ANNEXURE-II)

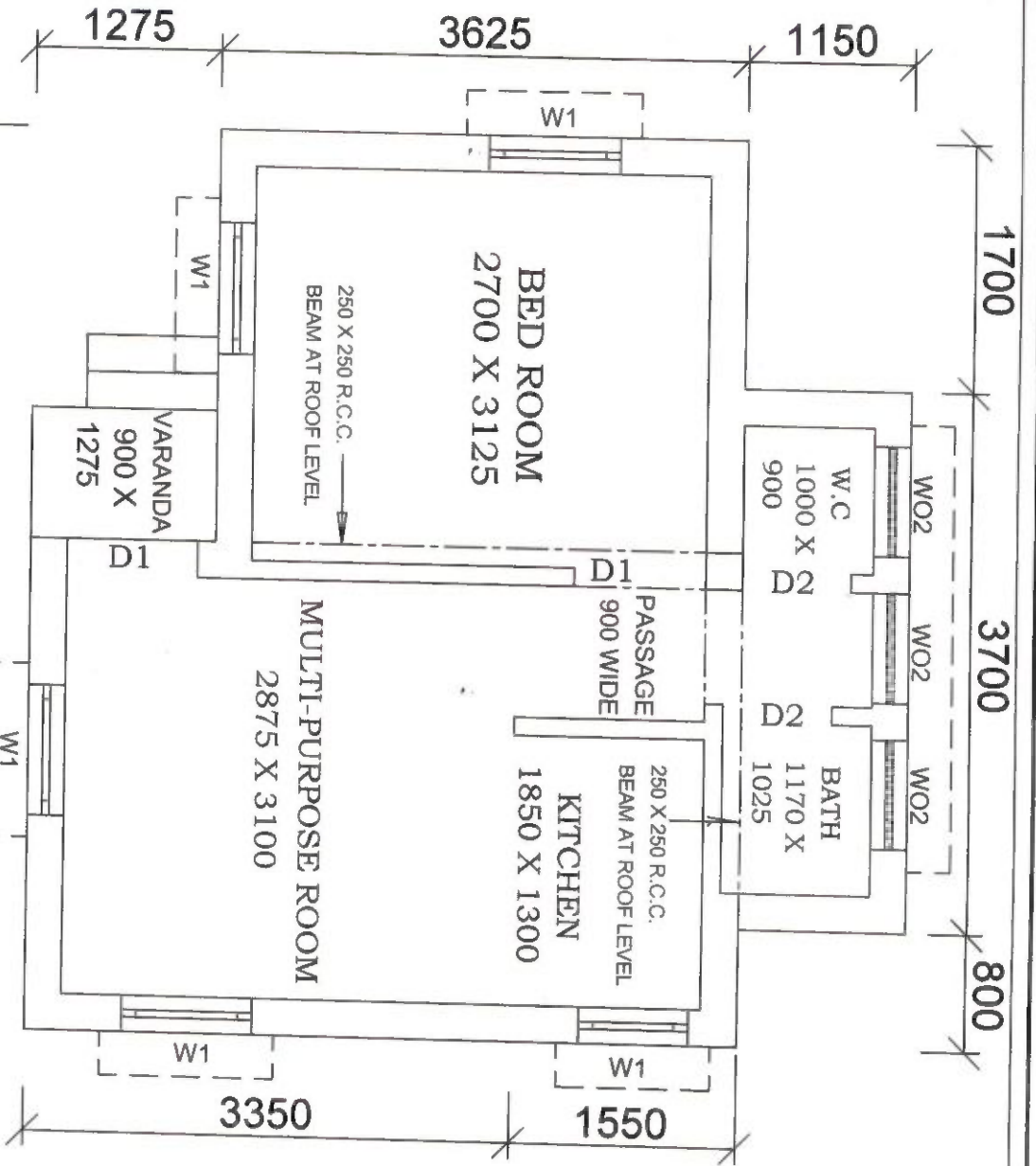
Sl No	Description of Items	Quantity	Unit	Rate	Amount
1	Earth work in excavation of foundation trenches or drains in all sorts of soil (including mixed soil but excluding or stacking the spoils within a lead of 75 m. as directed. The item includes necessary trimming the sides of trenches leveling dressing and ramming the bottom boiling out water aqs required complete. Depth of exavation not existing 1500mm P.No-1, I-2(a)	2.500	%Cu.M	12047.00	301.18
2	Cement concrete with graded jhama Khoa ballast (30 mm size) excluding shuttering. In ground floor and foundation (a) 6:3:1 proportion.	0.050	Cu.M	5803.06	290.15
3	Brick work with 1st class bricks in cement mortar (6:1). In foundation & Plinth P.no-29, I-21(a)	0.010	Cu.M	5719.00	57.19
4	125 mm. thick brick work with 1st class bricks in cement mortar (4:1) G.Floor P.no-31, I-29	3.000	SqM	714.00	2,142.00
5	Controlled Cement concrete with well graded stone chips (20 - mm nominal size) excluding shuttering and reinforcement with complete design of concrete as per I : 456 and relevant special publications submission of job mix formula after preliminary mix design after testing of concrete cubes as per direction of Engineer-in charge Consumption of cement will not be less than 300 Kg of cement -with Super plasticiser per cubic meter of controlled concrete but actual consumption will be determined on- the basis of preliminary test and job mix formula. -In ground floor and foundation. [Using concrete mixture] M 20 Grade P.no-12, I-6(a)	0.145	Cu.M	6871.54	996.37
6	Reinforcemnet for reinforced concrete work in all sorts of structures incl. Distribution bars, stirrups, binder etc. incl. supply of rods, initial straightening & removal of loose rust (if necessary), cutting to requisite length, hooking etc P.no-27, I-15(a)(i)	0.010	M.T	68508.00	685.08
7	Supplying, fitting and fixing UPVC down pipes A type and fittings conforming to IS 13592-1992 with necessary clamps nails including making holes in walls, etc. and cutting trenches in any soil, through masonry concrete structure etc. if necessary and mending good damages including jointing with jointing materials (Spun yarn, valamoid / bitumen / M. seal etc.) complete.				
	i) UPVC Pipe 110 mm dia P.no-173, I-21(A)(ii)	4.000	Mtr	291.00	1,164.00
	ii) UPVC Bend 87.5 degree 110 mm dia P.no-174, I-21(B)C(ii)	2.000	Each	162.00	324.00
8	Jaffri brick work 125 mm. thick with 1st class bricks in cement mortar (4:1) including 12 mm. thick cement plaster (4:1) in all faces in ground floor P.no-32, I-35	2.000	SqM	792.00	1,584.00
Cost of 2 no leach pit					7,543.97
Total=					7,544.00



- NOTE:-**
1. ALL WINDOW OPENINGS (W1&W2) WILL BE PROVIDED WITH Z-BATTEN SHUTTERS.
 2. ALL DOORS (D1&D2) -25TH Z-BATTERN SHUTTERS, SINGLE LEAF.
 3. W02 - OPENING PROVIDED WITH R.C.C. JALLI.
 4. PLINTH HEIGHT - 450 TH.
 5. CEILING HEIGHT - 2750 TH.
 6. MAIN WALL - 250 TH.
 7. PARTITION WALL - 125 TH.
 8. ROOF SLAB, BEAM, LINTEL, ETC. WITH REINFORCED CEMENT CONCRETE M20 GRADE.
 9. FLOOR OF VERANDAH, W.C, BATH, & KITCHEN ROOM TO BE KEPT 15 MM BELOW THE FLOOR LEVEL OF ROOM & PASSAGE.
 10. 100 MM TH. PIECE LINTEL OVER OPENING HAVE BEEN PROVIDED.
 11. ALL DIMENSION ARE IN MM.

DOORS & WINDOWS SCHEDULE	
MARKING	DIMENSION
W1	900 X 900
W2	750 X 900
W02	750 X 750
D1	900 X 2100
D2	750 X 2100

Sub-Assistant Engineer
HABRA MUNICIPALITY
 FLOOR AREA - 25.37 SQM.
 BUILT UP AREA - 32.18 SQM.

FOUNDATION DETAILS

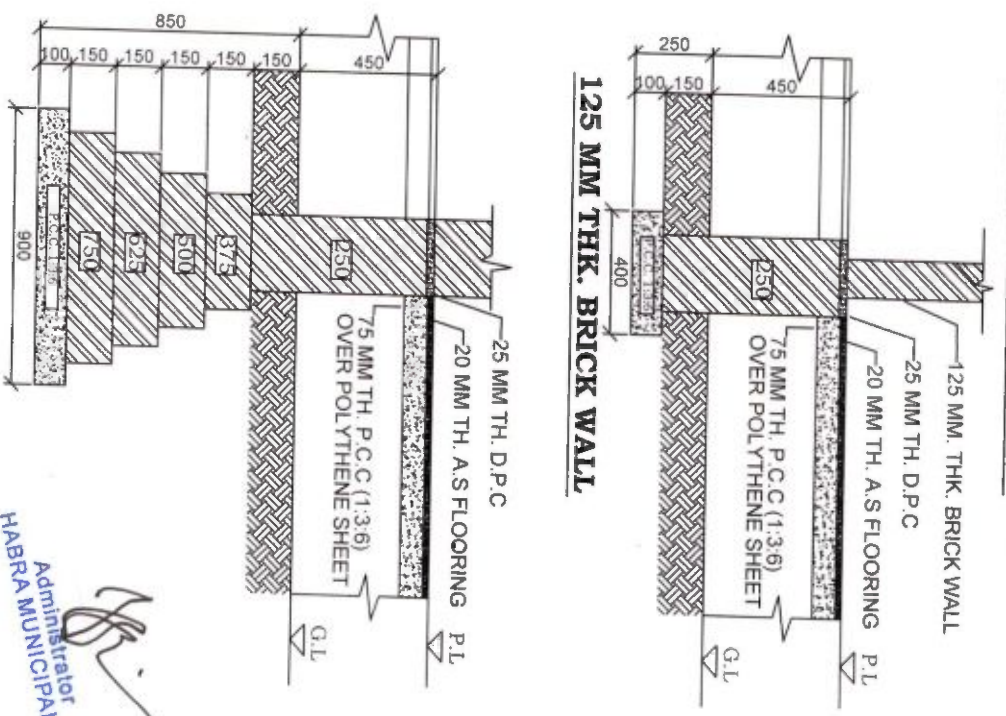

250 MM THK. BRICK WALL

125 MM THK. BRICK WALL

Administrator
HABRA MUNICIPALITY

PRADHAN MANTRI AWAS YOJANA
 HOUSING FOR ALL (URBAN)
OFFICE OF THE CHIEF ENGINEER
MUNICIPAL ENGINEERING DIRECTORATE
GOVT. OF WEST BENGAL

DWG. NO. _____ SCALE :- 1:50 & 1:25

ESTIMATE FOR CONSTRUCTION OF CONCRETE ROAD 2.00 METRE WIDE

PWD BUILDING SCHEDULE WITH EFFECT FROM 01.11.17

Considering Length = 30.00 M Wide 2.00 M

Sl No	Description of Items	No	Length	Breadh	Depth	Quantity	Unit	Rate	Amount
1	Earth work in excavation of foundation trenches or drains in all sorts of soil (including mixed soil but excluding or stacking the spoils within a lead of 75 m. as directed. The item includes necessary trimming the sides of trenches leveling dressing and ramming the bttom boiling out water aqs required complete . Depth of exavation not existing 1500mm P.No-1, I-2(a)	2	30.00	0.175	0.150	1.575	%Cu.M	11927.00	187.85
2	Supplying and laying polythene sheet (150 gm/m2) over damp proof course or in foundation or in foundation trenches P.No-45, I-13	2	30.00	0.175		10.500	Sqm	24.00	252.00
3	Single brick flat soling of picked jhama bricks including ramming and dressing bed to proper level and filling joints with powdered earth or local sand P.no-14, I-1		30.00	1.75		52.500	Sq.M	358.00	18,795.00
4	Hire and labour charges for shuttering with centering and necessary staging upto 4 m. using approved stout props and thick hard wood planks of approved thickness with required bracing for concrete slabs, beams, columns, lintels curved or straight including fitting, fixing and striking out after completion of works (upto roof of ground floor) 25 mm. to 30 mm thick wooden shutteing as per decision 7 direction of Engineer-in-Charge) P.no-43, I-36(f)	2	30.00		0.200	12.000	Sqm	209.000	2,508.00
5	125 mm thick brick work with 1st class bricks in cement mortar (1:4) in ground floor. P.No-16, I-16	2	30.00		0.150	9.000	Sqm	724.00	6,516.00
6	Ordinary Cement Concrete (mix1:2:4) with graded stone chips (20 mm nominal size) excluding shuttering and reinforcement, if any,in ground floor as per relevent IS codes. a) Pakur Variety Analysis Rate	2	30.00	0.125	0.075	0.563	Cu.M		
			30.00	2.00	0.125	7.500	Cu.M		
						8.063	Cu.M	5638.82	45462.99

Total Rs.= 73,721.84

Add 12% GST Rs.= 8846.62

Rs.= 82568.46

Add 1% Labour Welfare Cess Rs.= 825.68

Grand Total Rs.= 83394.14

Rate/Sq.Mtr = 1,389.90

Say Rs.= 1390.00

Sub-Assistant Engineer
HABRA MUNICIPALITY



Administrator
HABRA MUNICIPALITY

TYPICAL CROSS SECTION OF CEMENT CONCRETE ROAD

HABRA MUNICIPALITY

HABRA, NORTH 24 PARGANAS

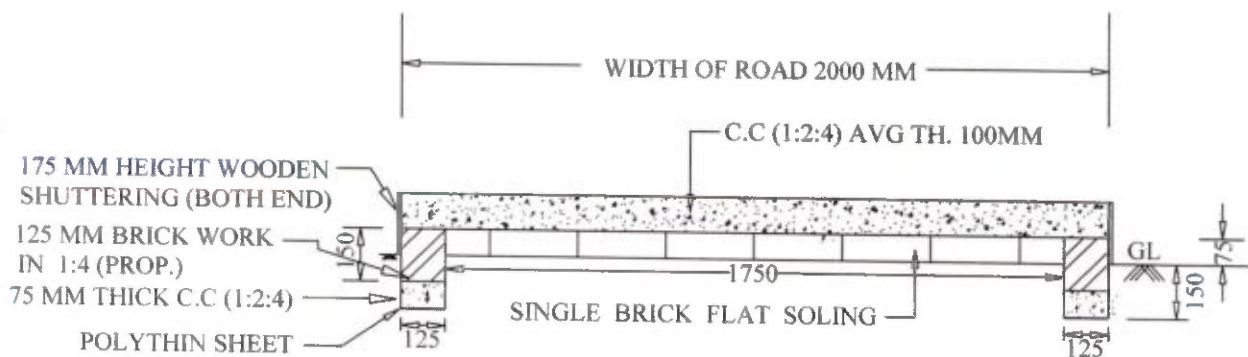
PMAY -HFA (Urban) : Habra Municipality



Sub-Assistant Engineer
HABRA MUNICIPALITY

Administrator
HABRA MUNICIPALITY

ESTIMATE FOR CONSTRUCTION OF SURFACE DRAIN (450X600)

PWD BUILDING SCHEDULE WITH EFFECT FROM 01.11.17

Considering Length= 30 M

SI No	Description of Items	No	Length	Breadth	Depth	Quantity	Unit	Rate	Amount
1	Earth work in excavation of foundation trenches or drains in all sorts of soil (including mixed soil but excluding or stacking the spoils within a lead of 75 m. as directed. The item includes necessary trimming the sides of trenches leveling dressing and ramming the bottom boiling out water aqs required complete. Depth of excavation not existing 1500mm P.No-1, I-2(a)		30.00	0.975	0.775	22.669	%Cu. M	11927.00	2,703.70
2	Single brick flat soling of picked jhama bricks including ramming and dressing bed to proper level and filling joints with powdered earth or local sand P.no-14, I-1		30.00	0.975		29.250	Sq.M	358.00	10,471.50
3	Ordinary Cement Concrete (mix1:2:4) with graded stone chips (20 mm nominal size) excluding shuttering and reinforcement, if any, in ground floor as per relevant IS codes. a) Pakur Variety Analysis Rate		30.00	0.975	0.100	2.925	Cu.M	5638.82	16,493.55
4	Brick work with 1st class bricks in cement mortar. (4 :1). a) In foundation & Plinth P.no-15, I-7		30.000	0.250	0.600	4.500	Cu.M	5575.00	25087.500
5	125 mm thick brick work with 1-st. class bricks in cement mortar (1:4) in ground floor. P.no-16, I-16		30.000		0.600	18.000	Sqm.	724.00	13032.000
6	Plaster (to wall, floor, ceiling etc.) with sand and cement mortar including rounding off or chamfering corners as directed and raking out joints or roughening of concrete surface including throating, nosing and drip course where necessary. (Gr.floor). i) With 6:1 cement mortar. a) 20 mm. Thick plaster. P.no-189, I-1		30.000		1.575	47.250	Sq.M	167.00	7890.750
	Neat cement punning above 1.5 mm thick in wall, dado, windowsills, floor, drain etc. P.no-192, I-15		30.000		1.575	47.250	Sq.M	34.00	1606.500
8	Artificial stone in floor dado staircase etc. with cement concrete 1:2:4 with stone chips laid in pannels as directed with topping made with ordinary or white cement (as measured) and marble dust in porportion (2:1) including smooth finishing and round (ii) 25 mm thick. P.no-48, I-6(ii)		30.000	0.450		13.500	Sq.M	269.00	3631.500

9	Hire and labour charges for shuttering with centering and necessary staging upto 4 m. using approved stout props and thick hard wood planks of approved thickness with required bracing for concrete slabs, beams, columns, lintels curved or straight including fitting, fixing and striking out after completion of works (upto roof of ground floor) a)25 mm. to 30 mm thick shutteing without staging in foundation. P.no-43, I-36(f) (For Tie100x150)	11	0.450	0.400		1.980	Sqm	209.00	413.820
10	Reinforcement for reinforced concrete work in all sorts of structures including distribution bars, stirrups, binders etc initial straightening and removal of loose rust (if necessary) cutting to requisite length, hooking and bending to correct shape, placing in proper position and binding with 16 gauge black annoaled wire at every intersection, complete as per drawing and didedction. (a) For works in foundation, basement and upto roof of ground floor/ upto 4.0 m. (i) Tor Steel / Mild Steel) Analysis Rate	11				0.024	MT	70362.85	1681.11
			For 1 No Tie: Main 4-8mm : 4x0.700x0.395kg/m=1.106 kg Ring 8mm: 6x0.450x0.395kg/m=1.066k g Total=(1.106+1.066)=2.172 kg						
11	Ordinary cement concrete (mix 1 : 1.5 : 3) with graded stone chips (20 mm nominal size) excluding shuttering and reinforcement if any, in ground floor as per relevant IS codes . (i) Pakur variety : Analysis Rate (For Tie-100x150)	11	0.700	0.100	0.150	0.116	Cum.	6184.13	714.27

Total Rs.= 83726.20

Add 12% GST Rs.= 10047.14

Rs.= 93773.34

Add 1% Labour Welfare Cess Rs.= 937.73

Grand Total Rs.= 94711.07

Rate/Mtr Length = 3,157.04

Say Rs.= 3157.00



Sub-Assistant Engineer
HABRA MUNICIPALITY

Administrator
HABRA MUNICIPALITY

HABRA MUNICIPALITY

HABRA, NORTH 24 PARGANAS

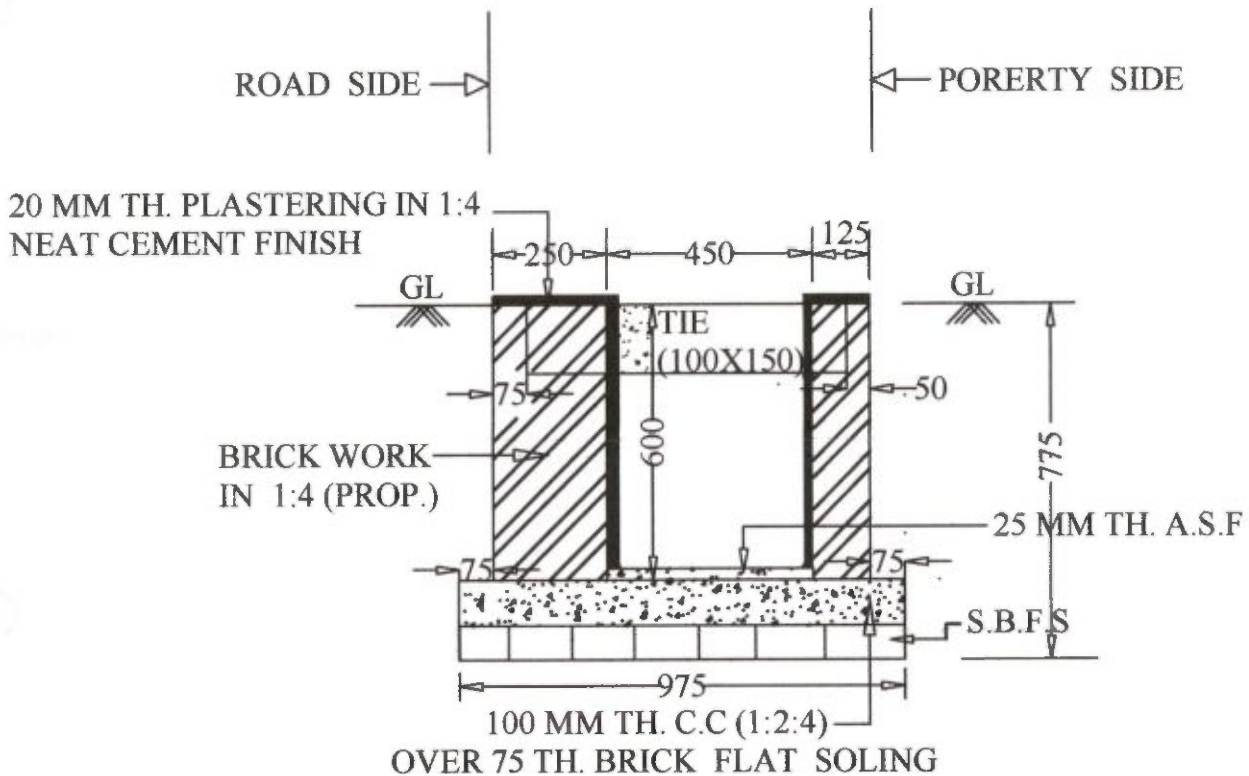
CROSS SECTION OF DRAIN (450 x 600) (SCALE - 1:50)



[Signature]
Sub-Assistant Engineer
HABRA MUNICIPALITY

[Signature]
Administrator
HABRA MUNICIPALITY

ESTIMATE FOR CONSTRUCTION OF ROAD PROTECTION WALL

PWD BUILDING SCHEDULE WITH EFFECT FROM 01.11.17

Considering Length= 30 M

SI No	Description of Items	No	Length	Breadth	Depth	Quantity	Unit	Rate	Amount
1	Earth work in excavation of foundation trenches or drains in all sorts of soil (including mixed soil but excluding or stacking the spoils within a lead of 75 m. as directed. The item includes necessary trimming the sides of trenches leveling dressing and ramming the bottom boiling out water aqs required complete. Depth of excavation not existing 1500mm P.No-1, I-2(a)		30.00	0.900	1.000	27.000	%Cu. M	11927.00	3,220.29
2	Single brick flat soling of picked jhama bricks including ramming and dressing bed to proper level and filling joints with powdered earth or local sand P.no-47, I-3		30.00	0.900		27.000	Sq.M	358.00	9,666.00
3	Ordinary Cement Concrete (mix1:2:4) with graded stone chips (20 mm nominal size) excluding shuttering and reinforcement, if any, in ground floor as per relevant IS codes. a) Pakur Variety Analysis Rate		30.00	0.900	0.100	2.700			
			30.00	0.250	0.075	0.563			
			Total=			3.263	Cu.M	5638.82	18,396.65
4	Brick work with 1st class bricks in cement mortar (4:1). a) In foundation & Plinth P.no-15, I-7		30.000	0.750	0.150	3.375			
			30.000	0.625	0.150	2.813			
			30.000	0.500	0.600	9.000			
			30.000	0.375	0.600	6.750			
			30.000	0.250	0.600	4.500			
			Total=			26.438	Cu.M	5575.00	147389.063
5	Plaster (to wall, floor, ceiling etc.) with sand and cement mortar including rounding off or chamfering corners as directed and raking out joints or roughening of concrete surface including throating, nosing and drip course where necessary. (Gr.floor). i) With 6:1 cement mortar. a) 20 mm. Thick plaster. P.no-189, I-1		30.000		2.000	60.000	Sq.M	167.00	10020.000
6	Neat cement punning above 1.5 mm thick in wall, dado, windowsills, floor, drain etc. P.no-192, I-15		30.000		2.000	60.000	Sq.M	34.00	2040.000
7	Providing Weep Holes in Brick Masonry/Plain/Reinforced concrete aboutment, wing wall/return wall with 100 mm dia AC pipe, extending through the full width of the structure with slope of 1V:20H towards drawing face. Complete as per drawing and Technical Specifications. P.no.-297, I-13.03(Road Schedule)	60					Each	126.00	7560.000

Total Rs.= 198292.00

Add 12% GST Rs.= 23795.04

Rs.= 222087.04

Add 1% Labour Welfare Cess Rs.= 2220.87

Grand Total Rs.= 224307.91

Rate/Mtr Length = 7,476.93

Say Rs.= 7477.00

HABRA MUNICIPALITY

HABRA, NORTH 24 PARGANAS

TYPICAL CROSS SECTION OF ROAD PROTECTION WALL

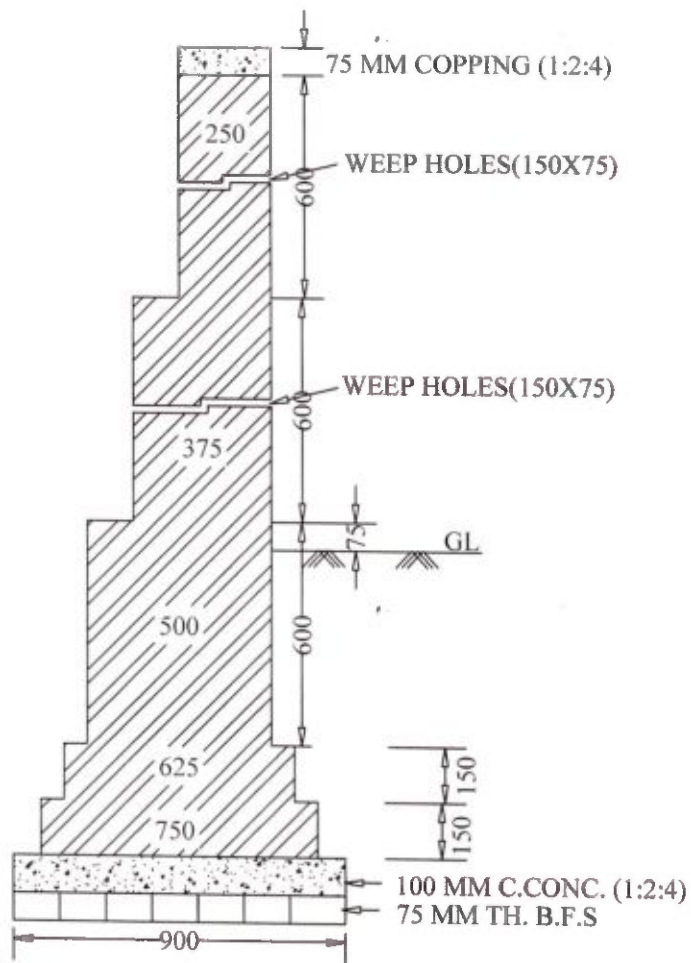

ESTIMATE FOR CONSTRUCTION OF DRAIN (600X900)

PWD BUILDING SCHEDULE WITH EFFECT FROM 01.11.17

Considering Length= 30 M

SI No	Description of Items	No	Length	Breadth	Depth	Quantity	Unit	Rate	Amount
1	Earth work in excavation of foundation trenches or drains in all sorts of soil (including mixed soil but excluding or stacking the spoils within a lead of 75 m. as directed. The item includes necessary trimming the sides of trenches leveling dressing and ramming the bttom boiling out water aqs required complete. Depth of exavation not existing 1500mm P.No-1, I-2(a)		30.000	1.375	1.075	44.3438	%Cu. M	11927.00	5,288.88
2	Single brick flat soling of picked jhama bricks including ramming and dressing bed to proper level and filling joints with powdered earth or local sand P.no-12, I-1		30.000	1.375		41.2500	Sq.M	358.00	14,767.50
3	Ordinary Cement Concrete (mix1:2:4) with graded stone chips (20 mm nominal size) excluding shuttering and reinforcement, if any, in ground floor as per relevent IS codes. a) Pakur Variety		30.000	1.375	0.100	4.1250	Cu.M	5638.82	23,260.13
4	Brick work with 1st class bricks in cement mortar (4:1). a) In foundation & Plinth P.no-30, I-21(a)		30.000	0.250	0.900	6.7500	Cu.M		
			30.000	0.375	0.900	10.1250	Cu.M		
						Total =	16.8750	5575.00	94078.125
5	Plaster (to wall, floor, ceiling etc.) with sand and cement mortar including rounding off or chamfering corners as directed and raking out joints or roughening of concrete surface including throating, nosing and drip course where necessary. (Gr.floor). i) With 4:1 cement mortar. a) 20 mm. Thick plaster. P.no-164, I-2(a)		30.000		2.575	77.2500	Sq.M	167.00	12900.750
6	Neat cement punning above 1.5 mm thick in wall, dado, windowsills, floor, drain etc. P.no-166, I-8		30.000		2.575	77.2500	Sq.M	34.00	2626.500
7	Artificial stone in floor dado staircase etc. with cement concrete 1:2:4 with stone chips laid in pannels as directed with topping made with ordinary or white cement (as measured) and marble dust in porportion (2:1) including smooth finishing and round (ii) 25 mm thick. P.no-41, I-3(ii)		30.000	0.600		18.0000	Sq.M	269.00	4842.000
8	Hire and labour charges for shuttering with centering and necessary staging upto 4 m. using approved stout props and thick hard wood planks of approved thickness with required bracing for concrete slabs, beams, columns, lintels curved or straight including fitting, fixing and striking out after completion of works (upto roof of groung floor) (f) 25 mm to 30 mm shuttering without staging in foundation. P.no-27, I-12(f)	118	0.900	0.200		21.2400	Sqm	209.00	4439.160

9	Reinforcement for reinforced concrete work in all sorts of structures including distribution bars, stirrups, binders etc initial straightening and removal of loose rust (if necessary) cutting to requisite length, hooking and bending to correct shape, placing in proper position and binding with 16 gauge black annealed wire at every intersection, complete as per drawing and didection. (a) For works in foundation, basement and upto roof of ground floor/ upto 4.0 m. (i) Tor Steel / Mild Steel) P.no-27, I-15 (For Tie-100x150)	118	For 1 No Tie: Main 4-8mm : 4x0.900x0.395kg/m=1.422 kg Ring 8mm: 7x0.450x0.395kg/m=1.244kg Total=(1.422+1.244)=2.666kg			0.314588	MT	70362.85	22135.31
10	Ordinary cement concrete (mix 1 : 1.5 : 3) with graded stone chips (20 mm nominal size) excluding shuttering and reinforcement if any, in ground floor as per relevant IS codes . (i) Pakur variety : (For Tie-100x150)	118	0.900	0.150	0.100	1.5930	Cum.	6184.13	9851.32

Total Rs.= 194189.67

Add 12% GST Rs.= 23302.76

Rs.= 217492.43

Add 1% Labour Welfare Cess Rs.= 2174.92

Grand Total Rs.= 219667.36

Rate/Mtr Length = 7,322.25

Say Rs.= 7322.00



 Sub-Assistant Engineer
 HABRA MUNICIPALITY

 Administrator
 HABRA MUNICIPALITY

CROSS SECTION OF DRAIN (600 x900) (SCALE - 1:50)

HABRA MUNICIPALITY HABRA, NORTH 24 PARGANAS

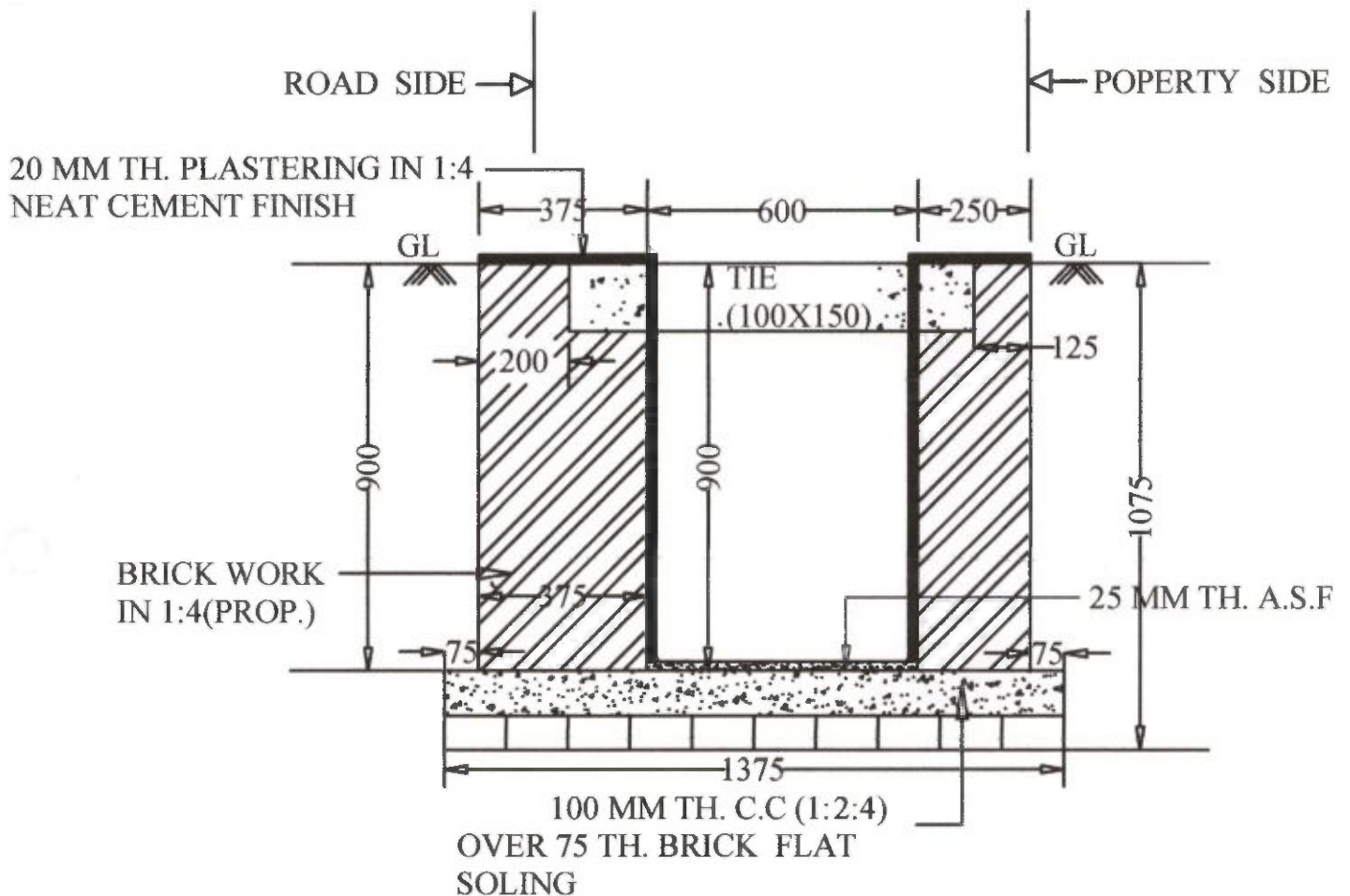
PMAY -HFA (Urban) : Habra Municipality









Sub-Assistant Engineer
HABRA MUNICIPALITY

Administrator
HABRA MUNICIPALITY

**BENEFICIARY
LIST**





**HABRA MUNICIPALITY
PMAY (HFA- 2019-20)**

BENEFICIARY LIST OF HABRA MUNICIPALITY

Sl. No.	Ward No	Slum / Non Slum	Name of Beneficiary	Father's Name / Husband's Name	Holding No./ Address	Category		Gender	Aadhaar No.	Photo
						Gen./S.C./O.B.C./S.T	Minority			
1.	1	Slum Area	ABU TALAB MONDAL	JAFAR MONDAL	AYERA COLONY	General	Yes	Male	531799968207	
2.	1	Slum Area	ALIM MALLICK	BAKKAR MALLICK	AYERA COLONY	General	Yes	Male	906298578562	
3.	1	Slum Area	ASIT SARKAR	ANIL SARKAR	DAHARTHUBA (WEST)	General		Male	881730185829	
4.	1	Slum Area	BACHARAM KARKMAKAR	LT SURESH KARMOKAR	DAHARTHUBA (WEST)	General		Male	334354254310	
5.	1	Slum Area	BHOLA TALUKDER	MUKUNDA TALUKDER	DAHARTHUBA (EAST)	General		Male	222969524778	
6.	1	Slum Area	BHULU BISWAS	LT MANARANJAN BISWAS	DAHARTHUBA (EAST)	General		Male	209848960307	
7.	1	Slum Area	BISHNU GHOSH	LT. GANESH CH. GHOSH	BELGORIA	General		Male	309937454542	

Sl. No.	Ward No	Slum / Non Slum	Name of Beneficiary	Father's Name / Husband's Name	Holding No./ Address	Category		Gender	Aadhaar No.	Photo
						Gen/S.C./O.B.C./S.T	Minority			
8.	1	Slum Area	BISWAJIT NANDI	SUBHAS NANDI	DAHARTHUBA (WEST)	General		Male	896220008347	
9.	1	Slum Area	CHITTARANJAN DEY	JOTINDRA NATH DEY	AYERA MUSLIM PARA	General		Male	999650776507	
10.	1	Slum Area	DIBAKAR DAS	LT. NANIGOPAL DAS	DAHARTHUBA (EAST)	General		Male	210031595959	
11.	1	Slum Area	DILIP DEBNATH	JOGESH DEBNATH	DAHARTHUBA (EAST)	General		Male	436995781627	
12.	1	Slum Area	DILIP DEY	LT. MAKHAN LAL DEY	DAHARTHUBA (EAST)	General		Male	650023417378	
13.	1	Slum Area	DIPAK BISWAS	DINESH BISWAS	BELGORIA	SC		Male	499775296467	
14.	1	Slum Area	GOPAL SARKAR	LT. ATUL SARKAR	BELGORIA	SC		Male	607875309932	
15.	1	Slum Area	GOURANGA DAS	YAGESWAR DAS	DAHARTHUBA (WEST)	General		Male	603288120378	

dy
Sub-Assistant Engineer
HABRA MUNICIPALITY

Sl. No.	Ward No	Slum / Non Slum	Name of Beneficiary	Father's Name / Husband's Name	Holding No./ Address	Category		Gender	Aadhaar No.	Photo
						Gen/S.C./O.B.C./S.T	Minority			
16.	1	Slum Area	HEMLATA KUNDU	SANTIRAM KUNDU	AYERA COLONY	OBC		Female	669873956622	
17.	1	Slum Area	JAYDEB DEBNATH	HAREKRISHNA DEBNATH	DAHARTHUBA (WEST)	General		Male	254872147147	
18.	1	Slum Area	JIAJUL MALLICK	JAHA BAKSH MALLICK	AYERA COLONY	General	Yes	Male	478890842750	
19.	1	Slum Area	JOGESH DAS	LT. KALIMOHAN DAS	DAHARTHUBA (EAST)	General		Male	330045967292	
20.	1	Slum Area	KADAMI DHALI	FANI DHALI	DAHARTHUBA (WEST)	General		Female	298743432989	
21.	1	Slum Area	KARUNA KUNDU	BINDABAN KUNDU	DAHARTHUBA (WEST)	General		Male	208802474395	
22.	1	Slum Area	KRISHNA DAS	JITENDRA DAS	DAHARTHUBA (EAST)	General		Male	862534576812	
23.	1	Slum Area	MAMPI SHIL	GOBINDRA CH SHIL	DAHARTHUBA (WEST)	General		Female	487275668404	









Sl. No.	Ward No	Slum / Non Slum	Name of Beneficiary	Father's Name / Husband's Name	Holding No./ Address	Category		Gender	Aadhaar No.	Photo
						Gen/S.C./O.B.C./S.T	Minority			
24.	1	Slum Area	MINATI BHOWMICK	GOPAL HALDER	DAHARTHUBA (EAST)	General		Female	254758778197	
25.	1	Slum Area	MOHID MALLICK	SAHAJAN MALLICK	AYERA COLONY	General	Yes	Male	838987659825	
26.	1	Slum Area	MONMOHAN MONDAL	KALU MONDAL	DAHARTHUBA (EAST)	General		Male	600345889388	
27.	1	Slum Area	MANTU DAS	MONAHAR DAS	BELGORIA	General		Male	668918676506	
28.	1	Slum Area	NANI GOPAL DAS	LT NARAYAN DAS	DAHARTHUBA (EAST)	General		Male	223314012988	
29.	1	Slum Area	NARAYAN DAS	LT BIPIN CH DAS	DAHARTHUBA (WEST)	General		Male	972358455190	
30.	1	Slum Area	NEMAI DAS	TARAPADA DAS	DAHARTHUBA (EAST)	General		Male	207253445837	
31.	1	Slum Area	NIRMAL BISWAS	UPANANDA BISWAS	BELGORIA	General		Male	693806905868	



Sl. No.	Ward No	Slum / Non Slum	Name of Beneficiary	Father's Name / Husband's Name	Holding No./ Address	Category		Gender	Aadhaar No.	Photo
						Gen/S.C./O.B.C./S.T	Minority			
32.	1	Slum Area	PRADIP GHOSH	LT. JAGADISH GHOSH	BELGORIA	General		Male	218354718873	
33.	1	Slum Area	PRASANTA DAS	KALIPADA DAS	DAHARTHUBA (EAST)	General		Male	313346942853	
34.	1	Slum Area	PROSENJIT SARKAR	MADHAB SARKAR	DAHARTHUBA (WEST)	General		Male	292895878634	
35.	1	Slum Area	PRİYOLAL BHAKTA	LT MANINDRA BHAKTA	DAHARTHUBA (WEST)	General		Male	760245284768	
36.	1	Slum Area	PROBHAS MONDAL	LT. BINAD BIHARI MONDAL	BELGORIA	SC		Male	208965335623	
37.	1	Slum Area	PUSHPA RANI SEN	LT. MOTILAL SEN	DAHARTHUBA (EAST)	General		Female	322015482770	
38.	1	Slum Area	RAJU SARDAR	DULAL SARDAR	AYERA MUSLIM PARA	General		Male	813511947351	
39.	1	Slum Area	SAHIDUL MOLLA	MOBARAK MOLLA	AYERA COLONY	General	Yes	Male	736347361140	







Sl. No.	Ward No	Slum / Non Slum	Name of Beneficiary	Father's Name / Husband's Name	Holding No./ Address	Category		Gender	Aadhaar No.	Photo
						Gen/S.C./O.B.C./S.T	Minority			
40.	1	Slum Area	SAMIR NAG	JAGADISH CH. NAG	AYERA MUSLIM PARA	General		Male	654666858504	
41.	1	Slum Area	SHYAMAPRASAD KAR	KISHARI MOHAN KAR	DAHARTHUBA (WEST)	General		Male	347198960730	
42.	1	Slum Area	SOVEN SARKAR	LT. ATUL SARKAR	BELGORIA	SC		Male	238894103452	
43.	1	Slum Area	SUBRATA KUNDU	ANNADA CHARAN KUNDU	AYERA COLONY	OBC		Male	385529329504	
44.	1	Slum Area	SUDEB DEBNATH	LT HAREKRISHNA DEBNATH	DAHARTHUBA (WEST)	General		Male	299493451560	
45.	1	Slum Area	TAPAS DAS	ASWINI KUMAR DAS	DAHARTHUBA (WEST)	General		Male	743173279888	
46.	1	Slum Area	TAPAS KUNDU	UPENDRA CH. KUNDU	DAHARTHUBA (WEST)	General		Male	903869398739	
47.	1	Slum Area	TARAK BAIDYA	KRISHNA KANTA BAIDYA	DAHARTHUBA (EAST)	General		Male	587392426871	









Sl. No.	Ward No	Slum / Non Slum	Name of Beneficiary	Father's Name / Husband's Name	Holding No./ Address	Category		Gender	Aadhaar No.	Photo
						Gen/S.C./O.B.C./S.T	Minority			
48.	1	Slum Area	UTTAM DUTTA	LT. NIIMAI DUTTA	BELGORIA	General		Male	891668462067	
49.	1	Slum Area	UTTAM KUNDU	ANNADA KUNDU	AYERA COLONY	General		Male	327864541486	
50.	1	Slum Area	NANIBALA SEN	GHANASHYAM DAS	DAHARTHUBA (EAST)	General		Female	669860733047	
51.	1	Slum Area	CHALIM MALLICK	ABU BAKKAR	AYERA	General	YES	Male	440043741240	
52.	1	Slum Area	ABDUL ALIM MONDAL	IMAM BAKS	AYERA	General	YES	Male	610969525351	
53.	1	Slum Area	MOSAROF HOSSAIN MALLICK	ABUL HOSSAIN	AYERA	GENERAL	YES	MALE	776961632847	
54.	1	Slum Area	PRADIP KUMAR DAS	NIRODH DAS	AYERA	GENERAL		MALE	563997358087	
55.	1	Slum Area	SEKHAR KUNDU	SANATAN KUNDU	AYERA	OBC		MALE	448503543317	



Sl. No.	Ward No	Slum / Non Slum	Name of Beneficiary	Father's Name / Husband's Name	Holding No./ Address	Category		Gender	Aadhaar No.	Photo
						Gen/S.C./O.B.C./S.T	Minority			
56.	1	Slum Area	GOPAL HALDER	GANENDRA HALDER	AYERA	GENERAL		MALE	775513337784	
57.	1	Slum Area	BAPPADITYA SARKAR	SAGAR SARKAR	AYERA	SC		MALE	799708148709	
58.	1	Slum Area	RADHA PADA SARKAR	SUBAL SARKAR	AYERA	SC		FEMALE	819621950031	
59.	1	Slum Area	CHANDAN KUNDU	TAPAN KUNDU	AYERA	OBC		MALE	916300186699	
60.	1	Slum Area	SANJAY DAS	GOPAL DAS	AYERA	SC		MALE	225810199671	
61.	1	Slum Area	RANJIT DAS	NAPALCHANDRA DAS	AYERA	SC		MALE	855177733447	
62.	1	Slum Area	RAMPRASAD GHOSH	RATAN GHOSH	BELGHARIA	OBC		MALE	675597667981	
63.	1	Slum Area	SANJIB KUNDU	SANTI RANJAN KUNDU	BELGHARIA	OBC		MALE	380475548147	

Sl. No.	Ward No	Slum / Non Slum	Name of Beneficiary	Father's Name / Husband's Name	Holding No./ Address	Category		Gender	Aadhaar No.	Photo
						Gen/S.C./O.B.C./S.T	Minority			
64.	1	Slum Area	PARITOSH DUTTA	BHUBAN MAHON DUTTA	BELGHARIA	OBC		MALE	650290170825	
65.	1	Slum Area	BIKASH CHANDRA DAS		BELGHARIA	OBC		MALE	507405243030	
66.	1	Slum Area	ASHIM GHOSH	RATAN GHOSH	BELGHARIA	OBC		MALE	588428875468	
67.	1	Slum Area	RAJU DAS	NIRAPADA DAS	BELGHARIA	SC		MALE	371747480212	
68.	1	Slum Area	PRABHAS DAS	NIRAPADA DAS	BELGHARIA	SC		MALE	399137094827	
69.	1	Slum Area	RINA BASU	SUKHDEB BASU	BELGHARIA	SC		FEMALE	848848974092	
70.	1	Slum Area	NETAI BISWAS	BIPIN BISWAS	DAHARTHUBA	SC		MALE	263360305359	
71.	1	Slum Area	NAYAN MAJUMDER	MONARANJAN MAJUMDER	DAHARTHUBA	SC		MALE	942200651515	

Sl. No.	Ward No	Slum / Non Slum	Name of Beneficiary	Father's Name / Husband's Name	Holding No./ Address	Category		Gender	Aadhaar No.	Photo
						Gen/S.C./O.B.C./S.T	Minority			
72.	1	Slum Area	NANTU SARKAR	MANGAL SARKAR	DAHARTHUBA	SC		MALE	367956093538	
73.	1	Slum Area	RADHESHYAM DAS	BIPIN DAS	DAHARTHUBA	SC		MALE	306266146217	
74.	1	Slum Area	TAPAN TALUKDER	NORASH TALUKDER	DAHARTHUBA	SC		MALE	873265666357	
75.	1	Slum Area	JIBAN DEBNATH	SUBHASH DEBNATH	DAHARTHUBA	OBC		MALE	889106491840	
76.	1	Slum Area	BISWA NANDI	HARIDAS NANDI	DAHARTHUBA	OBC		MALE	510965414157	
77.	1	Slum Area	SWAPAN DEBNATH	MOHANBASI DEBNATH	DAHARTHUBA	OBC		MALE	595070434260	
78.	1	Slum Area	NITUL DEBNATH	INDRABHUSAN DEBNATH	DAHARTHUBA	OBC		MALE	744902686863	
79.	1	Slum Area	SHYAMAL DAS	HAJARI DAS	DAHARTHUBA	SC		MALE	740760490093	



Sl. No.	Ward No	Slum / Non Slum	Name of Beneficiary	Father's Name / Husband's Name	Holding No./ Address	Category		Gender	Aadhaar No.	Photo
						Gen./S.C./O.B.C./S.T	Minority			
80.	1	Slum Area	HIRAN RAY	HARMAHAN RAY	DAHARTHUBA	SC		MALE	264708956137	
81.	1	Slum Area	PANCHANAN MALLICK	NAREN MALLICK	DAHARTHUBA	SC		MALE	462657973752	
82.	1	Slum Area	NAYAN SARKAR	HARARAM SARKAR	DAHARTHUBA	SC			221119416824	
83.	1	Slum Area	AMAR BISWAS	KHAGENDRA BISWAS	DAHARTHUBA	SC		MALE	266660375743	
84.	1	Slum Area	AKHIL SAHA	MUKUNDALAL SAHA	DAHARTHUBA	GENERAL		MALE	398249203708	
85.	1	Slum Area	SUBRATA MITRA	RANJAN MITRA	DAHARTHUBA	GENERAL		MALE	565722634816	
86.	1	Slum Area	AROBINDA SARKAR	RABINDRA NATH SARKAR	DAHARTHUBA	SC		MALE	451845663270	
87.	1	Slum Area	KAMAL RAY	SHYAMAL RAY	DAHARTHUBA	SC		MALE	720809155839	

Sl. No.	Ward No	Slum / Non Slum	Name of Beneficiary	Father's name / Husband's Name	Holding No./ Address	Category		Gender	Aadhaar No.	Photo
						Gen/S.C./O.B.C./S.T	Minority			
88.	1	Slum Area	SUPARNA BISWAS	AMAR BISWAS	DAHARTHUBA	SC		FEMAL	394085393408	
89.	1	Slum Area	SARASWATI DEBNATH	CHANDRAMOHAN DEBNATH	DAHARTHUBA	OBC		FEMALE	395029411488	
90.	1	Slum Area	SOMA SHIL	DHRUBO SHIL	DAHARTHUBA	OBC		FEMALE	604448001112	
91.	1	Slum Area	PURNIMA DAS	BABUL DAS	DAHARTHUBA	GENERAL		FEMALE	459338011138	
92.	1	Slum Area	SAMPA DAS	HORIKISHOR DAS	DAHARTHUBA	SC		FEMALE	996703121037	
93.	1	Slum Area	LATIKA DEBNATH	PURNA DEBNATH	DAHARTHUBA	OBC		MALE	931173838858	
94.	1	Slum Area	BASANTI MANDAL	BROJEN MANDAL	DAHARTHUBA	SC		MALE	475161194595	
95.	1	Slum Area	KANIKA SARDAR	BHOLA SARDAR		ST		MALE	276793862245	

Sl. No.	Ward No	Slum / Non Slum	Name of Beneficiary	Father's Name / Husband's Name	Holding No./ Address	Category		Gender	Aadhaar No.	Photo
						Gen/S.C./O.B.C./S.T	Minority			
96.	1	Slum Area	BISNUPADA SARKAR	RUPCHAND SARKAR	DAHARTHUBA	SC		MALE	368245899100	
97.	1	Slum Area	ANANDA MONDAL	ADHIR MONDAL	DAHARTHUBA	SC		MALE	785970155352	
98.	1	Slum Area	DOLY KUNDU	GOURPADA KUNDU	AYERA	OBC		FEMALE	446959704138	
99.	1	Slum Area	GOURANGA BHAKTA	MATILAL BHAKTA	DAHARTHUBA	SC		MALE	865606055984	
100.	1	Slum Area	KAJALI TALI	NANDALAL TALI	DAHARTHUBA	SC		FEMALE	323045352181	
101.	1	Slum Area	SUKHI HALDER	BIREN HALDER	DAHARTHUBA	SC		MALE	912914104633	
102.	1	Slum Area	JIBAN DHALI	JATIN DHALI	DAHARTHUBA	SC		MALE	372780108558	
103.	1	Slum Area	SAMAD MOLLA	MONAJAT	AYERA		YES	MALE	835912997741	







Sl. No.	Ward No	Slum / Non Slum	Name of Beneficiary	Father's Name / Husband's Name	Holding No./ Address	Category		Gender	Aadhaar No.	Photo
						Gen/S.C./O.B.C./S.T	Minority			
104.	1	Slum Area	PIYA SARDAR	BIKASH SARDAR	AYERA	SC		FEMALE	750376610178	
105.	1	Slum Area	TUSHAR ROY	HARIPADA ROY	DAHARTHUBA	GENERAL		MALE	851078111174	
106.	1	Slum Area	SANKAR BISWAS	NIBARAN BISWAS	DAHARTHUBA	SC		MALE	352416634974	
107.	1	Slum Area	MAHADEB GHOSH	KALIPADA GHOSH	DAHARTHUBA	OBC		MALE	377842510077	
108.	1	Slum Area	MANAS BISWAS	KALIPADA BISWAS	DAHARTHUBA	GENERAL		MALE	491166102279	
109.	1	Slum Area	JYOTILAL DAS	ARUN DAS	DAHARTHUBA	SC		MALE	579387684937	
110.	1	Slum Area	RABIN PAUL	KARTIK PAUL	DAHARTHUBA	OBC		MALE	634565577974	
111.	1	Slum Area	ANKA BALA BISWAS	NETAI BISWAS	DAHARTHUBA (WEST)	General		Female	796276881146	

Sl. No.	Ward No	Slum / Non Slum	Name of Beneficiary	Father's Name / Husband's Name	Holding No./ Address	Category		Gender	Aadhaar No.	Photo
						Gen/S.C./O.B.C./S.T	Minority			
112.	1	NON SLUM	BASUDEB DAS	ANANTA DAS	DAHARTHUBA	SC		Male	801086045287	
113.	1	Slum Area	BHASKAR DAS	SUNIL DAS	BELGORIA	General		Male	488819941420	
114.	1	NON SLUM	BISWAJIT SARKAR	PRASEN SARKAR	DAHATHUBA	OBC		Male	687039009096	
115.	1	SLUM AREA	CHANDANA BISWAS	SUBHASH BISWAS	DAHARTHUBA	SC		Female	598622470621	
116.	1	NON SLUM	DEVDAAS RAY	GOKUL RAY	DAHARTHUBA	SC		Male	624649444758	
117.	1	NON SLUM	DINOBANDHU BISWAS	GONESH BISWAS	DAHARTHUBA	SC		Male	379583091476	
118.	1	Slum Area	GIRISH CHANDRA SARKAR	LT. KRISHINA PADA SARKAR	DAHARTHUBA (EAST)	General		Male	647983056967	
119.	1	NON SLUM	GOURI KUNDU	SANATAN KUNDU	AYERA	OBC		Female	640692380977	







Sl. No.	Ward No	Slum / Non Slum	Name of Beneficiary	Father's Name / Husband's Name	Holding No./ Address	Category		Gender	Aadhaar No.	Photo
						Gen./S.C./O.B.C./S.T	Minority			
120.	1	NON SLUM	HRIDAY SINGH	NAGENDRA SINGH	DAHARTHUBA	SC		Male	483566655401	
121.	1	NON SLUM	JHARNA DAS	SHANTIPADA DAS	DAHARTHUBA	General		Female	253539167135	
122.	1	NON SLUM	JYOSTNA BARAL	UTTAM BARAL	DAHARTHUBA	SC		Female	456809258039	
123.	1	NON SLUM	KALIPADA MONDAL	DULAL MONDAL	DAHARTHUBA	SC		Male	830989972289	
124.	1	Slum Area	KARTICK ROY	LT DEBANDRA ROY	BELGORIA	SC		Male	847478320499	
125.	1	NON SLUM	LAKSHMI DAS	ANIL DAS	DAHARTHUBA	SC		Female	223410461130	
126.	1	NON SLUM	LITAN BAIDYA	BHUBAN BAIDYA	DAHARTHUBA	SC		Male	806286838673	
127.	1	NON SLUM	MILAN SUR	SURJA KANTA SUR	DAHARTHUBA	OBC		Male	531973111692	





Sl. No.	Ward No	Slum / Non Slum	Name of Beneficiary	Father's Name / Husband's Name	Holding No./ Address	Category		Gender	Aadhaar No.	Photo
						Gen/S.C./O.B.C /S.T	Minority			
128.	1	NON SLUM	MOUSUMI TALUKDER	JOYDEB TALUKDER	DAHATHUBA	SC		Female	417938285205	
129.	1	Slum Area	NANI DAS	DINABANDHU DAS	DAHARTHUBA (EAST)	General		Male	648323452672	
130.	1	NON SLUM	NAREN BALA	NIKHIL BALA	DAHARTHUBA	SC		Male	828436567412	
131.	1	NON SLUM	NIPAN DAS	AMAR DAS	DAHARTHUBA	SC		Male	525882224735	
132.	1	NON SLUM	NIVA ROY	CHITTRANJAN ROY	DAHARTHUBA	OBC		Female	577327905593	
133.	1	NON SLUM	PRAN KRISHNA ROY	DIJENDRA ROY	DAHARTHUBA	SC		Male	970202082407	
134.	1	Slum Area	PRONAB BHATTACHARYYA	LT AJIT BHATTACHARYYA	DAHARTHUBA (WEST)	General		Male	209542804038	
135.	1	NON SLUM	RANJIT SARKAR	GOUR SARKAR	DAHARTHUBA	SC		Male	428033728991	





Sl. No.	Ward No	Slum / Non Slum	Name of Beneficiary	Father's Name / Husband's Name	Holding No./ Address	Category		Gender	Aadhaar No.	Photo
						Gen/S.C./O.B.C./S.T	Minority			
136.	1	Slum Area	RIPAN DAS	LT. SUDHIR DAS	DAHARTHUBA (EAST)	General		Male	212533512617	
137.	1	NON SLUM	RIPON ROY	HARERAM ROY	DAHARTHUBA	SC		Male	311064495277	
138.	1	NON SLUM	RUMA SARKAR	RANJIT SARKAR	DAHARTHUBA	SC		Female	888052603420	
139.	1	NON SLUM	SAFIJUL MISTRI	LATIF MISTRI	AYERA	General	YES	Male	958313126873	
140.	1	NON SLUM	SANDHYA PAUL	ANIL PAUL	BELGHARIA	OBC		Female	428832530941	
141.	1	Slum Area	SANJIT KABIRAJ	LT. JAGADISH KABIRAJ	DAHARTHUBA (EAST)	General		Male	365195212747	
142.	1	Slum Area	SASTHIPADA DAS	CHITTRANJAN DAS	AYERA COLONY	General		Male	200887902467	
143.	1	NON SLUM	SAYEL DAS	MOTILAL DAS	DAHARTHUBA	SC		Male	543285350711	





Sl. No.	Ward No	Slum / Non Slum	Name of Beneficiary	Father's name / Husband's Name	Holding No./ Address	Category		Gender	Aadhaar No.	Photo
						Gen/S.C./O.B.C./J.S.T	Minority			
144.	1	Slum Area	SHYAMAL ROY	DEBEN ROY	DAHARTHUBA (WEST)	General		Male	216379500529	
145.	1	Slum Area	SIBPADA GHOSH	LT. PRAFULLA GHOSH	BELGORIA	General		Male	598470639047	
146.	1	NON SLUM	SIMA DAS	ARJUN DAS	AYERA	SC		Female	749154935275	
147.	1	NON SLUM	SONAMONI TALUKDER	MINTU TALUKDER	DAHARTHUBA	SC		Female	298973174143	
148.	1	NON SLUM	SUBRATA MONDAL	MUKUNDA MONDAL	DAHARTHUBA	SC		Male	389501855772	
149.	1	Slum Area	SUDIP DEY	NIRMAL DEY	DAHATHUBA	General		Male	787983985130	
150.	1	NON SLUM	SUJIT SARKAR	SHIRAMANI SARKAR	DAHATHUBA	SC		Male	824003953885	





Sl. No.	Ward No	Slum / Non Slum	Name of Beneficiary	Father's Name / Husband's Name	Holding No./ Address	Category		Gender	Aadhaar No.	Photo
						Gen/S.C./O.B.C./S.T	Minority			
151.	1	SLUM	PURNIMA KUNDU	KHAGEN KUNDU	UTTAR AYRA	OBC		FEMALE	590207402594	
152.	1	SLUM	TABUL MONDAL	MOJEM MONDAL	UTTAR AYRA		MINORITY	MALE	644478388403	
153.	1	SLUM	ARIFUL MOLLA	AMERA ALI MOLLA	UTTAR AYRA		MINORITY	MALE	645512798002	
154.	1	SLUM	DILIP DAS	SANTI DAS	UTTAR AYRA	SC		MALE	580657887908	
155.	1	SLUM	GOUTAM BISWAS	BINAY BISWAS	BELGHARIA	GEN		MALE	238171721536	
156.	1	SLUM	BIKASH DEY	ASHIM KUMAR DEY	DAHARTHUBA	GEN		MALE	840119303043	
157.	1	SLUM	CHIRANJIT DAS	SUBAL DAS	DAHARTHUBA	SC		MALE	328698100097	
158.	1	SLUM	PRASANTA SARKAR	SRIDAM SARKAR	DAHARTHUBA	OBC		MALE	801710876409	





Sl. No.	Ward No	Slum / Non Slum	Name of Beneficiary	Father's Name / Husband's Name	Holding No./ Address	Category		Gender	Aadhaar No.	Photo
						Gen/S. C./O. B. C /S.T	Minority			
159.	1	SLUM	SANJAY ROY	SWAPAN ROY	DAHARTHUBA	SC		MALE	779024721214	
160.	1	SLUM	NETAI GOSWAMI	BALORAM GOSWAMI	DAHARTHUBA	GEN		MALE	462808480949	
161.	1	Slum Area	YEANUR MONDAL	GOLAM HOSSAIN MONDAL	AYERA MUSLIM PARA	General	YES	Male	708269077651	
162.	1	SLUM	BABLU ROY	SUBAL ROY	DAHARTHUBA	OBC		MALE	400181110096	
163.	1	SLUM	ARUNAVHA BISWAS	ABHEDANANDA BISWAS	DAHARTHUBA	SC		MALE	705649399757	
164.	2	Slum	BIKASH DAS	SANTOSH DAS	HATTHUBA	SC	-	Male	797707739419	





Sl. No.	Ward No.	Slum / Non Slum	Name of Beneficiary	Father's Name / Husband's Name	Holding No./ Address	Category		Gender	Aadhaar No.	Photo
						Gen/S.C./O.B.C./S.T	Minority			
165.	2	Slum	PURNIMA BISWAS	BHANULAL DAS	HATTHUBA	GEN	-	Female	426645934703	
166.	2	Slum	RADHASHYAM DAS	PURNACHANDRA DAS	HATTHUBA	SC	-	Male	609050999315	
167.	2	Slum	DEBASHISH GHOSH	DILIP GHOSH	HATTHUBA	GEN	-	Male	693392843742	
168.	2	Slum	TIMIR DAS	RATNASHAR DAS	HATTHUBA	SC	-	Male	878471363403	
169.	2	Slum	SAMBU SAHA	MAKHAN LAL SAHA	HATTHUBA	SC	-	Male	824080830531	





Sl. No.	Ward No	Slum / Non Slum	Name of Beneficiary	Father's Name / Husband's Name	Holding No./ Address	Category		Gender	Aadhaar No.	Photo
						Gen/S. C./O.B.C./S.T	Minority			
170.	2	Slum	GOBINDALAL DUTTA	GOURANGA LAL DUTTA	HATTHUBA	GEN	-	Male	842397280598	
171.	2	Slum	ATUL CHANDRA DAS	SUKLAL DAS	HATTHUBA	GEN	-	Male	242674960764	
172.	2	Slum	NIRANJAN DAS	SHARAT DAS	HATTHUBA	SC	-	Male	363997330865	
173.	2	Slum	MILANI GHOSH	BHAJAHARI GHOSH	HATTHUBA	GEN	-	Female	682712318580	





Sl. No.	Ward No	Slum / Non Slum	Name of Beneficiary	Father's Name / Husband's Name	Holding No./ Address	Category		Gender	Aadhaar No.	Photo
						Gen/S.C./O.B.C./S.T	Minority			
174.	2	Slum	SANJOY DAS	SUNIL DAS	HATTHUBA	SC	-	Male	985910217876	
175.	2	Slum	ANJAN DAS	DULAL DAS	HATTHUBA	SC	-	Male	853062660951	
176.	2	Slum	SUBRATA DAS	DULAL DAS	HATTHUBA	SC	-	Male	420910495534	
177.	2	Slum	CHAITANYA MITRA	PRASHANTA MITRA	HATTHUBA	GEN	-	Male	406244436565	





Sl. No.	Ward No	Slum / Non Slum	Name of Beneficiary	Father's Name / Husband's Name	Holding No./ Address	Category		Gender	Aadhaar No.	Photo
						Gen/S.C./O.B.C./S.T	Minority			
178.	2	Slum	NITAI ROY	SATISH CH ROY	HATTHUBA	SC	-	Male	266694265132	
179.	2	Slum	ANUP DEBNATH	ABANI MOHAN DEBNATH	HATTHUBA	GEN	-	Male	459286593275	
180.	2	Slum	SURAJIT SAHA	KANTI BHUSAN SAHA	HATTHUBA	SC	-	Male	599183608407	
181.	2	Slum	SAMIR DUTTA	DULAL CHANDRA DUTTA	HATTHUBA	GEN	-	Male	850411060257	

Sl. No.	Ward No	Slum / Non Slum	Name of Beneficiary	Father's Name / Husband's Name	Holding No./ Address	Category		Gender	Aadhaar No.	Photo
						Gen/S.C./O.B.C./S.T	Minority			
182.	2	Slum	NARUGOPAL PAL	GANESH CH PAL	HATTHUBA	OBC	-	Male	940166535904	
183.	2	Slum	DIBYENDU GHOSH	KAMAL KUMAR GHOSH	HATTHUBA	GEN	-	Male	651038842707	
184.	2	Slum	RATAN KUMAR DAS	ANANTA DAS	HATTHUBA	SC	-	Male	594663290128	
185.	2	Slum	BISWANATH DAS	PULIN BIHARI DAS	HATTHUBA	SC	-	Male	736555991060	
186.	2	Slum	JUTHIKA DAS	KHAGEN SEN	HATTHUBA	SC	-	Male	682946894681	





Sl. No.	Ward No	Slum / Non Slum	Name of Beneficiary	Father's Name / Husband's Name	Holding No./ Address	Category		Gender	Aadhaar No.	Photo
						Gen/s.C./O.B.C./S.T	Minority			
187.	2	Slum	MAKHAN LAL SAMADDER	MAHENDRA SAMADDER	HATTHUBA	SC	-	Male	558338706170	
188.	2	Slum	CHANDI CHARAN DEY	ADHIR KUMAR DEY	HATTHUBA	GEN	-	Male	412517252235	
189.	2	Slum	RITA BISWAS	SANKAR KARMAKAR	HATTHUBA	SC	-	Female	807371459791	
190.	2	Slum	ALOK DAS	MAKHAM LAL DAS	HATTHUBA	SC	-	Male	752376270851	





Sl. No.	Ward No	Slum / Non Slum	Name of Beneficiary	Father's Name / Husband's Name	Holding No./ Address	Category		Gender	Aadhaar No.	Photo
						Gen/S. C./O. B. C. /S. T	Minority			
191.	2	Slum	SHYAMAL DUTTA	MANARANJAN DUTTA	HATTHUBA	GEN	-	Male	637806383913	
192.	2	Slum	RANAJIT DEY	NALINI BHUSAN DEY	HATTHUBA	GEN	-	Male	345675298057	
193.	2	Slum	NIMAI DHALI	NAREN DHALI	HATTHUBA	SC	-	Male	959965892174	
194.	2	Slum	NANDA DAS	SATYARANJAN SAMADDER	HATTHUBA	SC	-	Male	934856484765	





Sl. No.	Ward No	Slum / Non Slum	Name of Beneficiary	Father's Name / Husband's Name	Holding No./ Address	Category		Gender	Aadhaar No.	Photo
						Gen/S.C./O.B.C./S.T	Minority			
195.	2	Slum	NABAJIT DEY	SHYAMAL KRISHNA DEY	HATTHUBA	GEN	-	Male	222101960879	
196.	2	Slum	CHAMPA BALA PAUL	BIKASH CH PAUL	HATTHUBA	OBC	-	Female	883118399503	
197.	2	Slum	DILIP DEY	APURBA CH DEY	HATTHUBA	GEN	-	Male	274182862158	
198.	2	Slum	BHARATI MONDAL	BINOD SARKAR	HATTHUBA	SC	-	Female	635101861564	







Sl. No.	Ward No	Slum / Non Slum	Name of Beneficiary	Father's Name / Husband's Name	Holding No./ Address	Category		Gender	Aadhaar No.	Photo
						Gen/S.C./O.B.C./S.T	Minority			
199.	2	Slum	SUKANTA DEY	ANIL CH DEY	HATTHUBA	GEN	-	Male	666833116978	
200.	2	Slum	GANESH CH DEY	DURGA MOHAN DEY	HATTHUBA	GEN	-	Male	881416746626	
201.	2	Slum	KHOKAN DEY	HARIPADA DEY	HATTHUBA	GEN	-	Male	767741573917	
202.	2	Slum	PRANAB CHATTOPADHAY	KANAI LAL CHATTOPADHYAY	HATTHUBA	GEN	-	Male	810923186205	













Sl. No.	Ward No	Slum / Non Slum	Name of Beneficiary	Father's Name / Husband's Name	Holding No./ Address	Category		Gender	Aadhaar No.	Photo
						Gen/S.C./O.B.C./S.T	Minority			
203.	2	Slum	ANUP GHOSH	SUSHIL GHOSH	HATTHUBA	GEN	-	Male	204418159772	
204.	2	Slum	SUBHASH DUTTA	NIROD DUTTA	HATTHUBA	GEN	-	Male	289119228969	
205.	2	Slum	BIKASH DEY	SADHAN DEY	HATTHUBA	GEN	-	Male	543993579913	
206.	2	Slum	DIPANKAR SAHA CHOUHDURY	BISWANATH SAHA CHOUHDURY	HATTHUBA	GEN	-	Male	604275069693	
207.	2	Slum	ACHINTA DAS	AMULYA DAS	HATTHUBA	SC	-	Male	488424307556	





Sl. No.	Ward No	Slum / Non Slum	Name of Beneficiary	Father's Name / Husband's Name	Holding No./ Address	Category		Gender	Aadhaar No.	Photo
						Gen/S.C./O.B.C./S.T	Minority			
208.	2	Slum	DEBABRATA DAS	NIRMAL DAS	HATTHUBA	SC	-	Male	541897993565	
209.	2	Slum	TUTUL GHOSH	BHAGIRATH GHOSH	HATTHUBA	OBC	-	Male	750336746822	
210.	2	Slum	TUSHAR KANTI DAS	GOUR CH DAS	HATTHUBA	SC	-	Male	487819870870	
211.	2	Slum	KANAI LAL GUHA	ABANI MOHAN GUHA	HATTHUBA	GEN	-	Male	645338992489	
212.	2	Slum	SOMA NATH	NAKUL CH NATH	HATTHUBA	GEN	-	Male	330136810666	

Sl. No.	Ward No	Slum / Non Slum	Name of Beneficiary	Father's Name / Husband's Name	Holding No./ Address	Category		Gender	Aadhaar No.	Photo
						Gen/S.C./O.B.C./J.S.T	Minority			
213.	2	Slum	SAMIR DUTTA	UPENDRA NATH DUTTA	HATTHUBA	GEN	-	Male	667777158453	
214.	2	Slum	NIRAPADA DEY	NITAI DEY	HATTHUBA	GEN	-	Male	649212612423	
215.	2	Slum	GANESH DAS	SRIKRISHNA DAS	HATTHUBA	SC	-	Male	469591155130	
216.	2	Slum	JHARNA BISWAS	SAILEN DAS	HATTHUBA	SC	-	Female	958485918371	
217.	2	Slum	MAKHAN LAL SAMADDER	KALICHARAN SAMADDER	HATTHUBA	SC	-	Male	492115413485	





Sl. No.	Ward No	Slum / Non Slum	Name of Beneficiary	Father's Name / Husband's Name	Holding No./ Address	Category		Gender	Aadhaar No.	Photo
						Gen/S.C./O.B.C./S.T	Minority			
218.	2	Slum	NARAYAN KUMAR DAS	AKSHAY KUMAR DAS	HATTHUBA	SC	-	Male	563240599912	
219.	2	Slum	SHIBU PADA DUTTA	KALIPADA DUTTA	HATTHUBA	GEN	-	Male	474851524990	
220.	2	Slum	PRASENJIT GHOSH	RAJKUMAR GHOSH	HATTHUBA	OBC	-	Male	904659565578	
221.	2	Slum	NITAI DAS	RASH MOHAN DAS	HATTHUBA	SC	-	Male	266721917513	
222.	2	Slum	JYOSTNA DEY	HEMANTA KUMAR DUTTA	HATTHUBA	GEN	-	Female	448308403961	
223.	2	Slum	SUPRIYA SUR	RABIN SUR	HATTHUBA	GEN	-	Female	524898277209	







Sl. No.	Ward No	Slum / Non Slum	Name of Beneficiary	Father's Name / Husband's Name	Holding No./ Address	Category		Gender	Aadhaar No.	Photo
						Gen/S.C./O.B.C./S.T	Minority			
224.	2	Slum	RUPA DEY	INDU BHUSAN ACHARYA	HATTHUBA	GEN	-	Female	517520355252	
225.	2	Slum	PAPIYA DAS	DILIP DAS	HATTHUBA	SC	-	Female	583476061302	
226.	2	Slum	BABI SARKAR	BISWANATH SARKAR	HATTHUBA	SC	-	Male	673123671527	
227.	2	Slum	SHOBHONA DEY	GOPAL CHANDRA SINGHA	HATTHUBA	GEN	-	Female	659253356579	
228.	2	Slum	BIVA RANI DEY	LALIT MOHAN DEY	HATTHUBA	GEN	-	Female	272319657104	





Sl. No.	Ward No	Slum / Non Slum	Name of Beneficiary	Father's Name / Husband's Name	Holding No./ Address	Category		Gender	Aadhaar No.	Photo
						Gen/S.C./O.B.C./S.T	Minority			
228.	2	Slum	PALASH SAHA	NANI GOPAL SAHA	HATTHUBA	GEN	-	Male	577339076730	
230.	2	Slum	ARJUN CHANDRA SAHA	MADHU SUDHAN SAHA	HATTHUBA	SC	-	Male	975187946693	
231.	2	Slum	CHAYNA SAHA	BIRAJ MOHAN ROY	HATTHUBA	SC	-	Female	953145402620	
232.	2	Slum	KALA DAS	NAGEN CH DAS	HATTHUBA	SC	-	Male	737493022284	
233.	2	Slum	AMRITA MITRA DAS	TARAK MITRA	HATTHUBA	SC	-	Female	617483856620	

Sl. No.	Ward No	Slum / Non Slum	Name of Beneficiary	Father's Name / Husband's Name	Holding No./ Address	Category		Gender	Aadhaar No.	Photo
						Gen/S. C./O. B. C./S. T.	Minority			
234.	2	Slum	MINA DAS	JAMENI DAS	HATTHUBA	SC	-	Female	620024989000	
235.	2	Slum	BIDYUT SAHA	BADAL CH SAHA	HATTHUBA	SC	-	Male	881183534212	
236.	2	Slum	PRABIR MAJUMDER	PARIKSHIT MAJUMDER	HATTHUBA	GEN	-	Male	641277938431	
237.	2	Slum	SAILENDRA NATH DEY	ANUKUL CH DEY	HATTHUBA	GEN	-	Male	300722291271	
238.	2	Slum	RUPA RANI HALDER	DIPAK HALDER	HATTHUBA	GEN	-	Female	341456958287	

Sub-Assistant Engineer
HABRA MUNICIPALITY

Sl. No.	Ward No	Slum / Non Slum	Name of Beneficiary	Father's Name / Husband's Name	Holding No./ Address	Category		Gender	Aadhaar No.	Photo
						Gen/S.C./O.B.C./S.T	Minority			
239.	2	Slum	DULAL GHOSH	BANCHARAM GHOSH	HATTHUBA	GEN	-	Male	506960578894	
240.	2	Slum	PARESH DEY	NALINI RANJAN DEY	HATTHUBA	GEN	-	Male	449005001301	
241.	2	Slum	NAMITA DAS	SUBOL DAS	HATTHUBA	SC	-	Female	526940120649	
242.	2	Slum	ABHIJIT GHOSH	MANOMOHAN GHOSH	HATTHUBA	GEN	-	Male	337547277414	
243.	2	Slum	DIBAKAR KUMAR MONDAL	DULAL CH MONDAL	HATTHUBA	SC	-	Male	811949353349	

Sl. No.	Ward No	Slum / Non Slum	Name of Beneficiary	Father's Name / Husband's Name	Holding No./ Address	Category		Gender	Aadhaar No.	Photo
						Gen/S.C./O.B.C./S.T	Minority			
244.	2	Slum	GOURANGA CH DEY	SASHI KUMAR DEY	HATTHUBA	GEN	-	Male	274693911592	
245.	2	Slum	LIPI SAHA	PARITOSH PODDER	HATTHUBA	SC	-	Female	219341007853	
246.	2	Slum	CHANCHAL DAS	KANAI LAL DAS	HATTHUBA	SC	-	Male	266735755229	
247.	2	Slum	JAYDEB DHAR	KALIPADA DHAR	HATTHUBA	GEN	-	Male	903130930954	
248.	2	Slum	CHINU CHAKRABORTY	GANENDRA NATH BHATTACHARYA	HATTHUBA	GEN	-	Female	408088790276	
249.	2	Slum	GOBINDA SAHA	GURUPADA SAHA	HATTHUBA	SC	-	Male	707092572904	

Sl. No.	Ward No.	Slum / Non Slum	Name of Beneficiary	Father's Name / Husband's Name	Holding No./ Address	Category		Gender	Aadhaar No.	Photo
						Gen/S.C./O.B.C./S.T	Minority			
250.	2	Slum	BASANTI SAMADDER	RABINDRA NATH DAS	HATTHUBA	GEN	-	Female	272127916526	
251.	2	Slum	TANAY NANDI	TARAPADA NANDI	HATTHUBA	GEN	-	Male	772279639891	
252.	2	Slum	RABINDRA NATH GHOSH	BINOD BIHARI GHOSH	HATTHUBA	GEN	-	Male	874030233629	
253.	2	Slum	AVIJIT DEY	ASHOK DEY	HATTHUBA	GEN	-	Male	300338870618	
254.	2	Slum	SOUMITRA SADHU	BISWANATH SADHU	HATTHUBA	GEN	-	Male	271457535481	







Signature





Sub-Assistant Engineer
HABRA MUNICIPALITY







Sl. No.	Ward No	Slum / Non Slum	Name of Beneficiary	Father's Name / Husband's Name	Holding No./ Address	Category		Gender	Aadhaar No.	Photo
						Gen/S.C./O.B.C./S.T	Minority			
255.	2	Slum	ARUP DAS	ANIL DAS	HATTHUBA	SC	-	Male	479687458712	
256.	2	Slum	SUNIL DEY	NAGENDRA CH. DEY	HATTHUBA	GEN	-	Male	41279*5206523	
257.	2	Slum	BRINDABAN SAHA	CHITTA RANJAN SAHA	HATTHUBA	SC	-	Male	795768746319	
258.	2	Slum	SUJIT KUMAR DEY	NAGENDRA CHANDRA DEY	HATTHUBA	GEN	-	MALE	367362104736	
259.	2	Slum	ULLASHINI DUTTA	SUNIL DUTTA	HATTHUBA	GEN	-	FEMALE	646654789509	





[Signature]







Sub-Assistant Engineer
HABRA MUNICIPALITY







Sl. No.	Ward No	Slum / Non Slum	Name of Beneficiary	Father's Name / Husband's Name	Holding No./ Address	Category		Gender	Aadhaar No.	Photo
						Gen/S.C./O.B.C./S.T	Minority			
260.	03	SLUM	KALA SARDAR	KUSH SARDAR	HATTHUBA, GHOSHPARA	S.T		MALE	590515836026	
261.	03	SLUM	BASU DAS	KAMAL PADA DAS	HATTHUBA, HABRA	S.C		MALE	443152420204	
262.	03	SLUM	JHUMA GHOSH	BANSHI BADAN GHOSH	HATTHUBA, HABRA	O.B.C		FEMALE	326376935236	
263.	03	SLUM	KARTIK PAUL	SUNIL PAUL	HATTHUBA, HABRA	O.B.C		MALE	278863297758	
264.	03	SLUM	DULAL MAJUMDER	NIROD MAJUMDER	HATTHUBA, HABRA	S.C		MALE	275541196195	
265.	03	SLUM	TINKU SARDAR	SUNIL SARDAR	HATTHUBA, HABRA	S.T		MALE	595998594871	







Sl. No.	Ward No	Slum / Non Slum	Name of Beneficiary	Father's name / Husband's Name	Holding No./ Address	Category		Gender	Aadhaar No.	Photo
						Gen/S.C./O.B.C./S.T	Minority			
266.	03	SLUM	SAMBHU SARDAR	MANU SARDAR	HATTHUBA, GHOSH PARA	S.T		MALE	702411562051	
267.	03	SLUM	ASHIT GHOSH	NIMAI GHOSH	HATTHUB, HABRA	O.B.C		MALE	578367393222	
268.	03	SLUM	BISWANATH DAS	JATIN DAS	HATTHUBA ,HABRA	S.T		MALE	594965213595	
269.	03	SLUM	ACHINTA ROY	SHEKHAR ROY	HATTHUBA, HABRA	S.C		MALE	735518932564	
270.	03	SLUM	MANTU GAIN	MANORANJAN GAIN	HATTHUBA, HABRA	S.C		MALE	308126084415	
271.	03	SLUM	BAPI BISWAS	RABIN BISWAS	HATTHUBA, HABRA	S.C		MALE	270191041346	



Sl. No.	Ward No	Slum / Non Slum	Name of Beneficiary	Father's Name / Husband's Name	Holding No./ Address	Category		Gender	Aadhaar No.	Photo
						Gen/S.C./O.B.C./S.T	Minority			
272.	03	SLUM	SWAGATA MANDAL	ADITYA OJHA	HATTHUBA, GHOSH PARA	S.C		FEMALE	785572949354	
273.	03	SLUM	BISHNU DAS	GIRISH CHANDRA DAS	HATTHUBA, HABRA	S.C		MLE	635105563232	
274.	03	SLUM	ARUP GHOSH	PRAFULLA GHOSH	HATTHUBA, HABRA	O.B.C		MALE	687561875207	
275.	03	SLUM	BASUDEB BISWAS	SUBODH BISWAS	HATTHUBA, HABRA	S.C		MALE	754247654748	
276.	03	SLUM	PRASHANTA PAUL	CHAITANYA PAUL	HATTHUBA, HABRA	O.B.C		MALE	962092664200	
277.	03	SLUM	SURYA DAS	DHIREN DAS	HATTHUBA	S.C		MALE	900684338469	







Sl. No.	Ward No	Slum / Non Slum	Name of Beneficiary	Father's Name / Husband's Name	Holding No./ Address	Category		Gender	Aadhaar No.	Photo
						Gen/S.C./O.B.C./S.T	Minority			
278.	03	SLUM	SATYARANJAN DEY	DULAL KRISHNA DEY	DAS PARA, HATTHUBA	O.B.C		MALE	846938313190	
279.	03	SLUM	MIHIR BRAHMA	RABINDRA MOHAN BRAHMA	HATTHUBA, HABRA	O.B.C		MALE	644951693204	
280.	03	SLUM	SWAPAN DAS	THAKUR PADA DAS	HATTHUBA, HABRA	S.C		MALE	667052387536	
281.	03	SLUM	CHANDANA BISWAS	ARJUN PAIK	HATTHUBA, DAS PARA	O.B.C		FEMALE	931593202498	
282.	03	SLUM	SUCHANDA SEN	SUBHODH CH. PAUL	HATTHUBA, HABRA	O.B.C		FEMALE	922713341946	





Sl. No.	Ward No	Slum / Non Slum	Name of Beneficiary	Father's Name / Husband's Name	Holding No./ Address	Category		Gender	Aadhaar No.	Photo
						Gen/S.C./O.B.C./S.T	Minority			
283.	03	SLUM	PRASANTA GHOSH	KALIPADA GHOSH	HATTHUBA, HABRA	O.B.C		MALE	729526900194	
284.	03	SLUM	RATAN DAS	DILIP DAS	HATTHUBA, HABRA	S.C		MALE	299252116143	
285.	03	SLUM	TRIPTI ROY BISWAS	HARIPADA BISWAS	HATTHUBA, HABRA	S.C		FEMLE	221319292102	
286.	03	SLUM	SATYA RANJAN PAUL	NARAYAN CHANDRA PAUL	HATTHUBA, HABRA	O.B.C		MALE	271101366187	
287.	03	SLUM	DOLA BHADRA	KARTICK BISWAS	HABRA	O.B.C		FEMALE	956033425554	
288.	03	SLUM	SANJAY DAS	SUBHASH DAS	HATTHUBA, HABRA	S.C		MALE	873999423307	





Sl. No.	Ward No	Slum / Non Slum	Name of Beneficiary	Father's Name / Husband's Name	Holding No./ Address	Category		Gender	Aadhaar No.	Photo
						Gen/S.C./O.B.C./S.T	Minority			
289.	03	SLUM	RINA RANI PAUL	ASHWANI KUMAR DSA	HATTHUBA, HABRA	O.B.C		FEMALE	272226100675	
290.	03	SLUM	PABITRA BISWAL	BASANTA KUMAR BISWAL	HATTHUBA, HABRA	S.C		MALE	959440086630	
291.	03	SLUM	AVIJIT GHOSH	NEMAI GHOSH	HATTHUBA, HABRA	O.B.C		MALE	489318933753	
292.	03	SLUM	NIRANJAN GHOSH	HIRALAL GHOSH	HATTHUBA, HABRA	O.B.C		MALE	392171208820	
293.	03	SLUM	KARTICK SARKAR	BHOLANATH SARKAR	HATTHUUBA, HABRA	S.C		MALE	570004070972	
294.	03	SLUM	SABITA ROY	SUKHLAL ROY	HATTHUBA, HABRA	S.C		FEMALE	823916940145	





Sl. No.	Ward No	Slum / Non Slum	Name of Beneficiary	Father's Name / Husband's Name	Holding No./ Address	Category		Gender	Aadhaar No.	Photo
						Gen/S.C./O.B.C./S.T	Minority			
295.	03	SLUM	BALARAM BALA	DEBENDRA NATH BALA	HATTHUBA, HABRA	S.C		MALE	890350939587	
296.	03	SLUM	PRANAB KUMAR BISWAS	SHANTI RANJAN BISWAS	HATTHUBA, HABRA	S.C		MALE	436402033637	
297.	03	SLUM	SANDHYA SEN	MATILAL HALDAR	HATTHUBA, HABRA	O.B.C		FEMALE	459651502593	
298.	03	SLUM	SANEKA ROY	JANMOJOY ROY	HATTHUBA, HABRA	O.B.C		FEMALE	388872641502	
299.	03	SLUM	SUSHOVAN SARKAR	BIDYUT SARKAR	HATTHUBA, HABRA	S.C		MALE	228361838335	
300.	03	SLUM	PARIMAL NANDI	NEMAI NANDI	HATTHUBA, HABRA	O.B.C		MALE	207913362122	

Sl. No.	Ward No	Slum / Non Slum	Name of Beneficiary	Father's name / Husband's Name	Holding No./ Address	Category		Gender	Aadhaar No.	Photo
						Gen/S.C./O.B.C./S.T	Minority			
301.	03	SLUM	MANARANJAN HALDER	KALACHAND HALDER	HATTHUBA, HABRA	S.C		MALE	827768997420	
302.	03	SLUM	KINU PAUL	NARAN KUNDU	HATTHUBA, HABRA	O.B.C		MALE	548599160544	
303.	03	SLUM	MAHESHWAR DAS	MANORANJAN DAS	HABRA	S.T		MALE	575216400416	
304.	03	SLUM	ATUL SARDAR	BHARAT SARDAR	HATTHUBA, HABRA	S.T		MALE	740035338374	
305.	03	SLUM	SHYAMALI DEB	MAHADEB KUNDU	HATTHUBA, HABRA	O.B.C		FEMALE	204257449074	
306.	03	SLUM	AMALESH ROY	SURYA KANTA ROY	HATTHUBA, HABRA	O.B.C		MALE	384208330962	





Sl. No.	Ward No	Slum / Non Slum	Name of Beneficiary	Father's Name / Husband's Name	Holding No./ Address	Category		Gender	Aadhaar No.	Photo
						Gen/S.C./O.B.C./S.T	Minority			
307.	03	SLUM	NIRMAL SARDAR	MONOHARI SARDAR	HATTHUBA, HABRA	S.T		MALE	721714150892	
308.	03	SLUM	ASMINI SARDAR	BHABEN SARDAR	HATTHUBA, HBRA	S.T		MALE	547448145291	
309.	03	SLUM	NARU ROY	DINOBANDHU RAY	HATTHUBA, HABRA	O.B.C		MALE	223210728721	
310.	03	SLUM	ARCHANA PAUL	DULAL PAUL	HATTHUBA, HABRA	O.B.C		FEMALE	925631788187	
311.	03	SLUM	SHANKAR GHOSH	CHITTARANJAN GHOSH	HATTHUBA, HABRA	O.B.C		MALE	204902182636	
312.	03	SLUM	SANATH SADAR	BIMAL SARDAR	HATTHUBA, HABRA	S.T		MALE	464042338106	



Sl. No.	Ward No	Slum / Non Slum	Name of Beneficiary	Father's Name / Husband's Name	Holding No./ Address	Category		Gender	Aadhaar No.	Photo
						Gen/S.C./O.B.C./S.T	Minority			
313.	03	SLUM	RATAN SARKAR	NALINI BHUSAN SARKAR	HATTHUBA, HABRA	O.B.C		MALE	650478919106	
314.	03	SLUM	PABITRA GHOSH	DULAL GHOSH	HATTHUBA, HABRA	O.B.C		MALE	321194697001	
315.	03	SLUM	KARTICK GHOSH	SHRIKRISHNA GHOSH	HATTHUBA, HABRA	O.B.C		MALE	486031089452	
316.	03	SLUM	RANJAN SARDAR	JATIN SARDAR	HATTHUBA, HABRA	S.T		MALE	547952970733	
317.	03	SLUM	JAGABANDHU KUNDU	KRISHNA BHUSAN KUNDU	HATTHUBA, HABRA	O.B.C		MALE	858575129930	
318.	03	SLUM	SAMIR DEBNATH	DHIREN DEBNATH	HATTHUBA, GHOPSH PARA	O.B.C		MALE	225803916119	

Sl. No.	Ward No	Slum / Non Slum	Name of Beneficiary	Father's name / Husband's Name	Holding No./ Address	Category		Gender	Aadhaar No.	Photo
						Gen/S.C./O.B.C./S.T	Minority			
319.	03	SLUM	BISHWAJIT GHOSH	SADHAN GHOSH	HATHUBA, HABRA	O.B.C		MALE	256801673569	
320.	03	SLUM	CHAMPAK GHOSH	SANTOSH GHOSH	HATHUBA, HABRA	O.B.C		MALE	264596257521	
321.	03	SLUM	ANANTA DAS	ABHILASH DAS	HATHUBA, HABRA	S.C		MALE	857456717675	
322.	03	SLUM	HEMANGINI SARDAR	KANAI SARDAR	HATHUBA, HABRA	S.T		FEMALE	432035080148	
323.	03	SLUM	NAKUL DAS	PANCHU DAS	HATHUBA, HABRA	S.C		MALE	400364208271	
324.	03	SLUM	BIREN MONDAL	BASHUDEB MONDAL	HATHUBA, HABRA	S.C		MALE	706963051476	







Sl. No.	Ward No	Slum / Non Slum	Name of Beneficiary	Father's Name / Husband's Name	Holding No./ Address	Category		Gender	Aadhaar No.	Photo
						Gen/S.C./O.B.C./S.T	Minority			
325.	03	SLUM	AJIT BISWAS	NAKUL BISWAS	HATTHUBA, HABRA	S.C		MALE	889881551378	
326.	03	SLUM	SHYAMAL GHOSH	TARAPADA GHOSH	HATTHUBA, HABRA	OB.C		MALE	746844132561	
327.	03	SLUM	ARUP CHAKRABORTY	TAPAS CHAKRABORTY	HATTHUBA, HABRA	GEN		MALE	609392024257	
328.	03	SLUM	KAMAL PADA DAS	BALAI DAS	HATTHUBA, HABRA	S.C		MALE	933982378932	
329.	03	SLUM	CHAMPA MULLICK	NIROD MAJUMDER	HATTHUBA, HABRA	S.C		FEMALE	460191936866	
330.	03	SLUM	NAMITA GHOSH	SUBODH GHOSH	HTTHIUBA, HABRA	O.B.C		FEMALE	494205367394	

Sub-Assistant Engineer
HABRA MUNICIPALITY

Sl. No.	Ward No	Slum / Non Slum	Name of Beneficiary	Father's Name / Husband's Name	Holding No./ Address	Category		Gender	Aadhaar No.	Photo
						Gen/S.C./O.B.C./S.T	Minority			
331.	03	SLUM	SUKHRANJAN DAS	MANMOHAN DAS	HATTHUBA, HABRA	O.B.C		MALE	795140045629	
332.	03	SLUM	GOURANGA PAUL	GANESH CHANDRA PAUL	HATTHUBA	O.B.C		MALE	299374865179	
333.	03	SLUM	PARTHA PAUL	SANTI KUMAR PAUL	HATTHUBA, HABRA	O.B.C		MALE	464418483901	
334.	03	SLUM	BADAL KRISHNA DAS	HIRA LAL DAS	HATTHUBA, HABRA	S.C		MALE	688425334030	
335.	03	SLUM	GOUR CHANDRA PAUL	KALIPADA PAUL	HATTHUBA, HABRA	O.B.C		MALE	912519855415	
336.	03	SLUM	DHANANJAY SARDAR	ANIL SARDAR	HATTHUBA, HABRA	S.T		MALE	601818836637	





Sl. No.	Ward No	Slum / Non Slum	Name of Beneficiary	Father's Name / Husband's Name	Holding No./ Address	Category		Gender	Aadhaar No.	Photo
						Gen/S.C./O.B.C./S.T	Minority			
337.	04	Slum	Khokan Chakraborty	Late Abani Chakraborty	Joygachi, Habra, 24 P.G.S(N)	Gen		Male	504925693865	
338.	04	Slum	Alpana Saha	Nirmal Saha	Habra, 24 P.G.S(N)	SC		Female	898684016386	
339.	04	Slum	Bharati Saha	Kalachand Saha	Hatthuba, Habra, 24 P.G.S(N)	SC		Female	968707421790	
340.	04	Slum	Swapan Paul	Ganendra Nath Paul	Habra, 24 P.G.S(N)	Gen		Male	765049303788	
341.	04	Slum	Biswajit Roy	Volanath Ray	Akrampur, Habra, 24 P.G.S(N)	Gen		Male	287566713606	
342.	04	Slum	Narayan Paul	Fakir Paul	Hatthuba, Habra, 24 P.G.S(N)	Gen		Male	966976336711	





Sl. No.	Ward No	Slum / Non Slum	Name of Beneficiary	Father's Name / Husband's Name	Holding No./ Address	Category		Gender	Aadhaar No.	Photo
						Gen/S.C./O.B.C./S.T	Minority			
343.	04	Slum	Anima Paul	Madhusudan Paul	Jagachi, Habra, 2 4 P.G.S(N)	Gen		Female	927399683781	
344.	04	Slum	Biswanath Mitra	Tarapada Mitra	Habra, 24 P.G.S(N)	Gen		Male	333753947547	
345.	04	Slum	Gobinda Paul	Jotindra Paul	Habra, 24 P.G.S(N)	OBC		Male	529802179060	
346.	04	Slum	Jayanta Paul	Amar Paul	Habra, 24 P.G.S(N)	OBC		Male	692128083488	
347.	04	Slum	Rakhi Dey	Ram Chandra Dey	Habra, 24 P.G.S(N)	Gen		Female	374349762689	
348.	04	Slum	Bablu Bhattacharya	Chittaranja Bhattacharya	Ashoknagar, Kalyangarh	Gen		Male	264945139372	



Sl. No.	Ward No	Slum / Non Slum	Name of Beneficiary	Father's Name / Husband's Name	Holding No./ Address	Category		Gender	Aadhaar No.	Photo
						Gen/S.C./O.B.C./S.T	Minority			
349.	04	Slum	Dhira Bhawal	Sukumar Bhawal	Habra, 24 P.G.S(N)	Gen		Female	719562676795	
350.	04	Slum	Ratna Roy	Dinabandhu Dhar	Deshbandhu Road, Habra, 24 P.GS(N)	Gen		Female	893672308947	
351.	04	Slum	Sadhana Das	Panchanan Das	Kuchila, Gobarda nga	SC		Female	228781613812	
352.	04	Slum	Aup Kundu	Avimunnu Kundu	Joygachi, Habra, 24 P.G.S (N)	Gen		Male	658496143115	
353.	04	Slum	Rajeswar Biswas	Radheshyam Biswas	Habra, 24 P.G.S(N)	SC		Male	405612259217	
354.	04	Slum	Sikha Dey	Kumud Ranjan Bose	Hatthuba, Habra, 24 P.G.S (N)	Gen		Female	744280769506	



Sub-Assistant Engineer
HABRA MUNICIPALITY

Sl. No.	Ward No	Slum / Non Slum	Name of Beneficiary	Father's Name / Husband's Name	Holding No./ Address	Category		Gender	Aadhaar No.	Photo
						Gen/S.C./O.B.C./S.T	Minority			
355.	04	Slum	Biplab Das	Hiralal Das	Hatthuba, Habra, 24 P.G.S (N)	SC		Male	383553611413	
356.	04	Slum	Soumen Chakraborty	Pranab Chakraborty	Chowgacha, Gai ghata	Gen		Male	267668171451	
357.	04	Slum	Bhola Rajbanshi	Pannanath Rajbanshi	Baguiati, Rajarhat	Gen		Male	585426516823	
358.	04	Slum	Nilay Som	Hari Pada Som	Joygachi, Habra, 24 P.G.S (N)	Gen		Male	509433720399	
359.	04	Slum	Puspa Rani Mistri	Mahadeb Roy	Habra, 24 P.G.S(N)	SC		Female	847579761133	
360.	04	Slum	Swapan Roy	Adhir Roy	Joygachi, Habra, 24 P.G.S (N)	Gen		Male	839036935241	

Sl. No.	Ward No	Slum / Non Slum	Name of Beneficiary	Father's Name / Husband's Name	Holding No./ Address	Category		Gender	Aadhaar No.	Photo
						Gen/S.C./O.B.C./S.T	Minority			
361.	04	Slum	Dipu Bhowmik	Dilip Kumar Bhowmik	Joygachi, Habra, 24 P.G.S (N)	Gen		Male	206876344179	
362.	04	Slum	Gobinda Chakraborty	Girish Chakraborty	Joygachi, Habra, 24 P.G.S(N)	Gen		Male	679229577467	
363.	04	Slum	Sanjita Halder	Nikunja Halder	Joygachi, Habra, 24 P.G.S (N)	Gen		Female	324883167246	
364.	04	Slum	Ram Kundu	Madan Gopal Kundu	Habra, 24 P.G.S(N)	Gen		Male	655235495410	
365.	04	Slum	Radheshyam Biswas	Bipin Biswas	Habra, 24 P.G.S(n)	Gen		Male	630851547273	
366.	04	Slum	Nilima Roy	Nirmal Haldar	Habra, 24 P.G.(n)	Gen		Female	802548925813	





Sl. No.	Ward No	Slum / Non Slum	Name of Beneficiary	Father's Name / Husband's Name	Holding No./ Address	Category		Gender	Aadhaar No.	Photo
						Gen/S.C./O.B.C./S.T	Minority			
367.	04	Slum	Amit Kumar Bapari	Manoranjan Bapari	Kamarthuba, Habra, 24 P.G.S(N)	Gen		Male	239110818861	
368.	04	Slum	Simul Paul Kundu	Rabin Kumar Paul Kundu	Lake Town	Gen		Male	726510001904	
369.	04	Slum	Ranjit Mondal	Rameshar Mondal	Joygachi, 24 P.G.S (N)	SC		Male	291067190596	
370.	04	Slum	Goutam Sikder	Gopal Sikder	Habra, 24 P.G.S(N)	Gen		Male	669042457996	
371.	04	Slum	Dipankar Paul	Purnachandra Paul	Hatthuba, Habra, 24 P.G.S (N)	Gen		Male	492502250719	
372.	04	Slum	Rinku Halder	Paritosh Halder	Habra, 24 P.G.S (N)	Gen		Male	693375809884	





Sl. No.	Ward No	Slum / Non Slum	Name of Beneficiary	Father's Name / Husband's Name	Holding No./ Address	Category		Gender	Aadhaar No.	Photo
						Gen/S.C./O.B.C./S.T	Minority			
373.	04	Slum	SANDHYA CHATTERJEE	FANI DRA KUMAR BANERJEE	JOYGACHI, DESHBANDHU ROAD	Gen		FEMALE	895763528271	
374.	04	Slum	SADHAN PAUL	PARITOSH PAUL	JOYGACHI	Gen		MALE	286472657291	
375.	04	Slum	ANIMESH KUMAR DUTTA	UTTAM KUMAR DUTTA	JOYGACHI	Gen		MALE	820051265661	
376.	5	SLUM	JAYANTI SARDAR	GANGARAM SARDAR	JAIGACHI 30 NO RAIL GATE	S.T		FEMALE	357315205495	
377.	5	SLUM	SANJAY ROY	SITAL CHANDRA ROY	JAIGACHI 31 NO RAIL GATE	GEN		MALE	948570189260	





[Signature]

Sl. No.	Ward No	Slum / Non Slum	Name of Beneficiary	Father's Name / Husband's Name	Holding No./ Address	Category		Gender	Aadhaar No.	Photo
						Gen/S.C./O.B.C./S.T	Minority			
378.	5	SLUM	PRADIP GHOSH	KALIPADA GHOSH	ADARSHAPALLI	GEN		MALE	443465620434	
379.	5	SLUM	AMAL ROY	JEETENDRA ROY	JAIGACHI 30 NO RAIL GATE	SC		MALE	559435111528	
380.	5	SLUM	AJOY SADHU	AMAL SADHU	ADARSHAPALLI	GEN		MALE	212614182752	
381.	5	SLUM	BULA GHOSH	NARAYAN DAS	ADARSHAPALLI	GEN		FEMALE	922213657537	
382.	5	SLUM	BASU DEV PAUL	RASIK PAUL	ADARSHA PALLI	GEN		MALE	446113012746	
383.	5	SLUM	AMALA BAGCHI	RANJAN ROY	JAIGACHI 31 NO RAILGATE	GEN		FEMALE	617479081023	

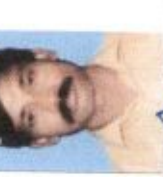
Sl. No.	Ward No	Slum / Non Slum	Name of Beneficiary	Father's Name / Husband's Name	Holding No./ Address	Category		Gender	Aadhaar No.	Photo
						Gen/S.C./O.B.C./S.T	Minority			
384.	5	SLUM	BASANTI GHOSH	TARAPADA DEY	JAIGACHI 30 NO RAIL GATE	GEN		FEMALE	665676371298	
385.	5	SLUM	MRINAL KANTI DEY	SUSHIL KUMAR DEY	JAIGACHI 31 NO RAIL GATE	GEN		MALE	266470571273	
386.	5	SLUM	GANESH BISWAS	NIKUNJA BISWAS	JAIGACHI 30 NO RAIL GATE	GEN		MALE	758766119477	
387.	5	SLUM	SUBHANKAR KUNDU	SHITAL KUNDU	JAIGACHI 30 NO RAIL GATE	GEN		MALE	583702300185	
388.	5	SLUM	KUMARI SARDAR	RABI SARDAR	JAIGACHI 30 NO RAIL GATE	ST		MALE	214767186087	
389.	5	SLUM	DILIP SARDAR	RATAN SARDAR	JAIGACHI 30 NO RAIL GATE	ST		MALE	262038698724	





Sl. No.	Ward No	Slum / Non Slum	Name of Beneficiary	Father's Name / Husband's Name	Holding No./ Address	Category		Gender	Aadhaar No.	Photo
						Gen/S.C./O.B.C./S.T	Minority			
390.	5	SLUM	RABANTI SARDAR	SANJIT SARDAR	JAIGACHI 30 NO RAIL GATE	ST		MALE	899170787639	
391.	5	SLUM	SHILA KUNDU	KANAI SAHA	ADARSHAPALLI	GEN		FEMALE	439415825808	
392.	5	SLUM	JAYANTI SEN	KALIPADA SEN	JAIGACHI 30 NO RAIL GATE	GEN		FEMALE	374323850410	
393.	5	SLUM	MAYA MONDAL	GAURANGA ROY	JAIGACHI 31 NO RAIL GATE	SC		FEMALE	690446613518	
394.	5	SLUM	NITAI SAHA	PANCHANAN SAHA	ADARSHAPALLI	GEN		MALE	433080972417	

Sl. No.	Ward No	Slum / Non Slum	Name of Beneficiary	Father's Name / Husband's Name	Holding No./ Address	Category		Gender	Aadhaar No.	Photo
						Gen/S.C./O.B.C./S.T	Minority			
395.	5	SLUM	SOMA ROY	DILIP ROY	ADARSHA PALLI	GEN		FEMALE	864288578344	
396.	5	SLUM	GOBINDA DAS	UPENDRA DAS	JAIGACHI COLONY	GEN		MALE	790556342034	
397.	5	SLUM	SARASWATI SARDAR	KISHAN SARDAR	JAIGACHI 30 NO RAILGATE	ST		FEMALE	465556433925	
398.	5	SLUM	LAXMAN SARDAR	KARTICK SARDAR	JAIGACHI 30 NO RAILGATE	ST		MALE	525588557398	
399.	5	SLUM	RAJESH RAM	MANIK RAM	JAIGACHI 31 NO RAILGATE	GEN		MALE	686500029329	
400.	5	SLUM	SRIKANTA MISTRI	LABKANTA MISTRI	JAIGACHI 31 NO RAILGATE	SC		MALE	439089999582	





Sl. No.	Ward No	Slum / Non Slum	Name of Beneficiary	Father's name / Husband's Name	Holding No./ Address	Category		Gender	Aadhaar No.	Photo
						Gen/S.C./O.B.C./S.T	Minority			
401.	5	SLUM	TUSHAR ROY	MONORANJAN ROY	JAIGACHI 31 NO RAILGATE	GEN		MALE	754166836458	
402.	5	SLUM	LAXMI BANIK	RAM NARESH BHAGAT	ADARSHA PALLI	GEN		FEMALE	635297088967	
403.	5	SLUM	ANANDA KUNDU	BIMAL KUMAR KUNDU	JAIGACHI 31 NO RAILGATE	GEN		MALE	250820043670	
404.	5	SLUM	ANIL BALA	BIJENDRA BALA	JAIGACHI COLONY	SC		MALE	429069342023	
405.	5	SLUM	BIDHAN BISWAS	PRAFULLA BISWAS	JAIGACHI COLONY	SC		MALE	725370013189	







Sl. No.	Ward No	Slum / Non Slum	Name of Beneficiary	Father's name / Husband's Name	Holding No./ Address	Category		Gender	Aadhaar No.	Photo
						Gen/S.C./O.B.C./S.T	Minority			
406.	5	SLUM	SANJIB DAS	DILIP DAS	JAIGACHI COLONY	GEN		MALE	613424020810	
407.	5	SLUM	BIBHASH SIKDER	BHUPENDRA SIKDER	JAIGACHI COLONY	GEN		MALE	702637714605	
408.	5	SLUM	MANJU SARKAR	'BANIBHUSAN SIKDER	JAIGACHI COLONY	GEN		MALE	987651165633	
409.	5	SLUM	RABINDRA NATH HAZARI	MAKHAN LAL HAZARI	JAIGACHI COLONY	GEN		MALE	436851217370	
410.	5	SLUM	GOPAL SIKDER	KALIPADA SIKDER	JAIGACHI COLONY	GEN		MALE	668163355222	
411.	5	SLUM	GOBINDA DAS	AMULYA RATAN DAS	JAIGACHI COLONY	GEN		MALE	816109955456	

Sub-Assistant Engineer
HABRA MUNICIPALITY

Sl. No.	Ward No	Slum / Non Slum	Name of Beneficiary	Father's Name / Husband's Name	Holding No./ Address	Category		Gender	Aadhaar No.	Photo
						Gen/S.C./O.B.C./S.T.	Minority			
412.	5	SLUM	ANUP DAS	SUDARSHAN DAS	JAIGACHI COLONY	GEN		MALE	827279712204	
413.	5	SLUM	SUBHRA SHIL	SUKHARANJAN SHIL	JAIGACHI COLONY	GEN		MALE	232018065698	
414.	5	SLUM	DAYAL DHALI	KALIKRISHNA DHALI	JAIGACHI 30 NO RAILGATE	GEN		MALE	783516148970	
415.	5	SLUM	ARUN SARKAR	ANIL SARKAR	JAIGACHI COLONY	GEN		MALE	296161763084	
416.	5	SLUM	GOBINDA DAS	BINAY BHUSAN DAS	JAIGACHI COLONY	GEN		MALE	792535323658	
417.	5	SLUM	GEETA GUHA	SATISH BISWAS	JAIGACHI COLONY	GEN		FEMALE	582840113915	











Sl. No.	Ward No	Slum / Non Slum	Name of Beneficiary	Father's Name / Husband's Name	Holding No./ Address	Category		Gender	Aadhaar No.	Photo
						Gen/S.C./O.B.C./S.T	Minority			
418.	5	SLUM	MINTU SHIL	SURENDRA MOHAN SHIL	JAIGACHI COLONY	GEN		MALE	563663742255	
419.	5	SLUM	RANJIT KUMAR PAUL	NETAI CHANDRA PAUL	JAIGACHI COLONY	GEN		MALE	898410639514	
420.	5	SLUM	KIRAN SARDAR	SUKHCHAND SARDAR	JAIGACHI 31 NO RAIL GATE	ST		MALE	329447132270	
421.	5	SLUM	SANTANU DUTTA	JOGESH CHANDRA DUTTA	JAIGACHI 30 NO RAIL GATE	GEN		MALE	438427247976	
422.	5	SLUM	PARITOSH DAS	CHITTARANJAN DAS	JAIGACHI 30 NO RAIL GATE	GEN		MALE	543407181087	
423.	5	SLUM	MANIK SARKAR	MANINDRANATH SARKAR	JAIGACHI 31 NO RAILGATE	GEN		MALE	634613480197	







Sl. No.	Ward No	Slum / Non Slum	Name of Beneficiary	Father's Name / Husband's Name	Holding No./ Address	Category		Gender	Aadhaar No.	Photo
						Gen/S.C./O.B.C./S.T	Minority			
424.	5	SLUM	SHIBU SAHA	KHITISH SAHA	JAIGACHI COLONY	GEN		MALE	299227361824	
425.	5	SLUM	DILIP SHIL	SUNIL SHIL	JAIGACHI COLONY	GEN		MALE	281601239241	
426.	5	SLUM	TAPAS DUTTA	TARUN DUTTA	JAIGACHI COLONY	GEN		MALE	229580802590	
427.	5	SLUM	NITISH BISWAS	SHEFALI BISWAS	JAIGACHI COLONY	GEN		MALE	970208765989	
428.	5	SLUM	MAHADEB HAZARI	MAKHAN HAZARI	JAIGACHI COLONY	GEN		MALE	381683502918	
429.	5	SLUM	DEBASHISH CHAKRABORTY	GOPAL CHAKRABORTY	JAIGACHI COLONY	GEN		MALE	338449628205	





(Signature)





Sub-Assistant Engineer
HABRA MUNICIPALITY







Sl. No.	Ward No	Slum / Non Slum	Name of Beneficiary	Father's name / Husband's Name	Holding No./ Address	Category		Gender	Aadhaar No.	Photo
						Gen/S.C./O.B.C./S.T	Minority			
430.	5	SLUM	ANIMA SARKAR	CHITYA SARKAR	JAIGACHI COLONY	GEN		MALE	634340860732	
431.	5	SLUM	SUNIL KUMAR PAUL	KANAK PAUL	ADARSHA PALLI	GEN		MALE	637961322080	
432.	5	SLUM	BINA SHIL	SACHINDA KUMAR SHIL	JAIGACHI COLONY	GEN		MALE	503195054416	
433.	5	SLUM	JATIN PAUL	MAHENDRA PAL	JAIGACHI 31 NO RAILGATE	GEN		MALE	236423862799	
434.	5	SLUM	RANU SHIL	NANI GOPAL SHIL	JAIGACHI COLONY	GEN		FEMALE	772926917156	
435.	5	SLUM	ANIL PAL	KALIPADA PAL	ADARSHAPALLI	GEN		MALE	574871449547	

Sl. No.	Ward No	Slum / Non Slum	Name of Beneficiary	Father's Name / Husband's Name	Holding No./ Address	Category		Gender	Aadhaar No.	Photo
						Gen/S.C./O.B.C./S.T	Minority			
436.	5	SLUM	DILIP DAS	SUDARSHAN DAS	JAIGACHI COLONY	GEN		MALE	569323464347	
437.	5	SLUM	PADAKRISHNA PAUL	MAHENDRA PAUL	JAIGACHI 31 NO RAILGAGTE	GEN		MALE	838476249198	
438.	5	SLUM	SHILPI MONDAL	SONA BASI MONDAL	JAIGACHI 31 NO RAILGAGTE	SC		FEMALE	513669861183	
439.	5	SLUM	SUBAL SIKDER	JATINDRA CHANDRA SIKDER	MATHPARA	GEN		MALE	972199908672	
440.	5	SLUM	LUCKY MALAKAR	KALIDAS DEY	JAIGACHI COLONY	GEN		FEMALE	465321458521	



Sl. No.	Ward No	Slum / Non Slum	Name of Beneficiary	Father's Name / Husband's Name	Holding No./ Address	Category		Gender	Aadhaar No.	Photo
						Gen/S.C./O.B.C./S.T	Minority			
441.	5	SLUM	BABULA BHAKTA	SADANANDA BHAKTA	MATHPARA	GEN		MALE	747509575627	
442.	5	SLUM	BIKASH ROY	RADHYASHAM ROY	ADARSHAPALLI	GEN		MALE	865761536296	
443.	5	Slum	SANJAY PAUL	CHITTARANJAN PAUL	30 No. Rail Gate	GEN		MALE	522212088875	
444.	5	SLUM	SANJIB ROY	PRIYALAL ROY	JOYGACHI COLONY	SC		MALE	979983026700	
445.	5	SLUM	ANKAR KUDU	MANORANJAN KUNDU	ADARSHAPALLI	GEN		MALE	757398958443	
446.	5	SLUM	GOPAL PAUL	KHAGEN PAUL	JAIGACHI COLONY	GEN		MALE	937298365702	





Sl. No.	Ward No	Slum / Non Slum	Name of Beneficiary	Father's Name / Husband's Name	Holding No./ Address	Category		Gender	Aadhaar No.	Photo
						Gen/S.C./O.B.C./S.T.	Minority			
447.	5	SLUM	MITHUN CHAKRABORTY	RATAN CHAKRABORTY	JAIGACHI COLONY	GEN		MALE	840278769886	
448.	5	SLUM	SAMIR BISWAS	HARIPADA BISWAS	JAIGACHI 31 NO RAILGATE	SC		MALE	714925108862	
449.	5	SLUM	MUKTI PRASAD PAUL	JYOTIPRASAD PAUL	JAIGACHI 30 NO RAILGATE				413754071293	
450.	5	SLUM	PINTU SAHA	KAMAL LAL SAHA	JAIGACHI 30 NO RAIL GATE	GEN		MALE	'591857528007	
451.	5	SLUM	SWATI DUTTA	JOGESH DUTTA	JAIGACHI ADARSHAPALLI	GEN		FEMALE	279646159131	







Sl. No.	Ward No	Slum / Non Slum	Name of Beneficiary	Father's Name / Husband's Name	Holding No./ Address	Category		Gender	Aadhaar No.	Photo
						Gen/S.C./O.B.C /S.T	Minority			
452.	5	SLUM	SABITA RANI KUNDU	NIL KRISHNA KUNDU	JAIGACHI COLONY	GEN		MALE	355922168329	
453.	5	SLUM	DIBAKAR SEN	SWAPAN KUMAR SEN	JAIGACHI ADARSHAPALLI	GEN		MALE	'200231117154	
454.	5	SLUM	APARNA PRAMANICK	PRABHAT CHANDRA SHIL	JAIGACHI 30 NO RAILGATE	GEN		MALE	938337409695	
455.	5	SLUM	SUKAMAL DAS	BACHINDRA DAS	JAIGACHI COLONY	GEN		MALE	668566843457	

Sl. No.	Ward No	Slum / Non Slum	Name of Beneficiary	Father's Name / Husband's Name	Holding No./ Address	Category		Gender	Aadhaar No.	Photo
						Gen/S.C./O.B.C./S.T	Minority			
456.	5	SLUM	CHHANDA SAHA	SURESH CHANDRA SAHA	JAIGACHI 30 NO RAILGATE	GEN		MALE	719765726946	
457.	5	SLUM	AMALENDU NATH	JIBAN KRISHNA NATH	JAIGACHI COLONY	GEN		MALE	916849177799	
458.	6	SLUM	BALAJ SAHA	LT. BIBHUTI BHUSAN SAHA	EAST KAMARTHUBA	GEN		Male	633098501444	
459.	6	SLUM	BIJOY DAS	PARSANATH MONDAL	EAST KAMARTHUBA	GEN		Male	429743006641	
460.	6	SLUM	ARCHANA MONDAL	LOKENATH SAJI	EAST KAMARTHUBA	SC		Female	231542179178	
461.	6	SLUM	BISHNUPADA DUTTA	NEPAL CH. DUTTA	EAST KAMARTHUBA	GEN		Male	338710077983	







Signature

Sl. No.	Ward No	Slum / Non Slum	Name of Beneficiary	Father's Name / Husband's Name	Holding No./ Address	Category		Gender	Aadhaar No.	Photo
						Gen/S.C./O.B.C./S.T.	Minority			
462.	6	SLUM	DIPANKAR DEBNATH	BISHAWMABHAR DEBNATH	EAST KAMARTHUBA	OBC		Male	548276577632	
463.	6	SLUM	MUKUNDA NASKAR	KISHORI MOHAN NASKAR	EAST KAMARTHUBA	SC		Male	617969231572	
464.	6	SLUM	PRADIP PAUL	LALIT MOHAN PAUL	EAST KAMARTHUBA	GEN		Male	208552861699	
465.	6	SLUM	SANJIB MISTRI	MOTILAL MISTRI	EAST KAMARTHUBA	SC		Male	46176500079	
466.	6	SLUM	MANOBANCHA DAS	NIBARAN DAS	EAST KAMARTHUBA	SC		Female	894539218836	
467.	6	SLUM	RAM CH. DAS	NANI GOPAL DAS	EAST KAMARTHUBA	SC		Male	454020387239	



Sl. No.	Ward No	Slum / Non Slum	Name of Beneficiary	Father's Name / Husband's Name	Holding No./ Address	Category		Gender	Aadhaar No.	Photo
						Gen./S.C./O.B.C./S.T	Minority			
468.	6	SLUM	RENU DAS		EAST KAMARTHUBA	SC		Female	960438455335	
469.	6	SLUM	GITA SARKAR	MAKHANLAL SARKAR	EAST KAMARTHUBA	SC		Female	245129076450	
470.	6	SLUM	TAPASI KUNDU	SUDHIR KUNDU	EAST KAMARTHUBA	SC		Female	813354130715	
471.	6	SLUM	BISWANATH KUNDU	BIRENDRANATH KUNDU	EAST KAMARTHUBA	SC		Male	876189757606	
472.	6	SLUM	DULAL DAS	ABINASH DAS	EAST KAMARTHUBA	SC		Male	629395457063	







Sl. No.	Ward No	Slum / Non Slum	Name of Beneficiary	Father's Name / Husband's Name	Holding No./ Address	Category		Gender	Aadhaar No.	Photo
						Gen/S.C./O.B.C./S.T	Minority			
473.	6	SLUM	RITA BISWAS	SUDHIR NANDI	EAST KAMARTHUBA	SC		Female	995301465717	
474.	6	SLUM	RAM GOPAL SAHA	PUSHTALAL SAHA	EAST KAMARTHUBA	GEN		Male	868736396107	
475.	6	SLUM	TILAK HAZRA	NAGEN HAZRA	EAST KAMARTHUBA	SC		Male	377135005033	
476.	6	SLUM	SHUBHENDU DEBNATH	DINESH DEBNATH	EAST KAMARTHUBA	GEN		Male	648202346950	
477.	6	SLUM	DIPENDU DEBNATH	DINESH DEBNATH	EAST KAMARTHUBA	GEN		Male	592013374173	
478.	6	SLUM	SUKH SARDAR	SAHADEB SARDAR	EAST KAMARTHUBA	ST		Male	571421110348	







Sl. No.	Ward No	Slum / Non Slum	Name of Beneficiary	Father's Name / Husband's Name	Holding No./ Address	Category		Gender	Aadhaar No.	Photo
						Gen/S.C./O.B.C./S.T	Minority			
479.	6	SLUM	ANAMIKA ROY CHOWDHURY	SOCHIPRASWANA PAUL	EAST KAMARTHUBA	GEN		Male	295519922979	
480.	6	SLUM	CHOTAN DEY	NEPAL DEY	EAST KAMARTHUBA	GEN		Male	863833901599	
481.	6	SLUM	PRIYA BALA DAS	PURNA CHANDA DAS	EAST KAMARTHUBA	SC		Female	456824421022	
482.	6	SLUM	SHIBU DEY	NEPAL DEY	EAST KAMARTHUBA	GEN		Female	296828364208	
483.	6	SLUM	NANDITA ADHIKARY		EAST KAMARTHUBA	GEN		Female	242863625841	
484.	6	SLUM	PURNENDU DEBNATH	HARIPADA DEBNATH	EAST KAMARTHUBA	SC		Male	943618159296	



Sl. No.	Ward No	Slum / Non Slum	Name of Beneficiary	Father's Name / Husband's Name	Holding No./ Address	Category		Gender	Aadhaar No.	Photo
						Gen/S.C./O.B.C./S.T	Minority			
485.	6	SLUM	MANJU DEBNATH	SHAMBHU DEBNATH	EAST KAMARTHUBA	GEN		Female	762994444535	
486.	6	SLUM	ETI MONDAL	BIMAL DEBNATH	EAST KAMARTHUBA	SC		Female	618389548170	
487.	6	SLUM	NARAYAN DEBNATH		EAST KAMARTHUBA	GEN		Male	631254766257	
488.	6	SLUM	PINTU BISWAS	DEBENDRA NATH BISWAS	EAST KAMARTHUBA	SC		Male	240985360522	
489.	6	SLUM	DEBASISH KUNDU	LT. BASUDEB KUNDU	EAST KAMARTHUBA	SC		Male	703506617983	
490.	6	SLUM	DEBASISH MOULICK	HIMANGSU MOULICK	EAST KAMARTHUBA	SC		Male	296704631226	





[Signature]
Sub-Assistant Engineer
HABRA MUNICIPALITY



Sl. No.	Ward No	Slum / Non Slum	Name of Beneficiary	Father's Name / Husband's Name	Holding No./ Address	Category		Gender	Aadhaar No.	Photo
						Gen/S.C./O.B.C./S.T	Minority			
491.	6	SLUM	TITU NASKAR	MANORANJAN HALDER	EAST KAMARTHUBA	SC		Female	888439998656	
492.	6	SLUM	DILIP DEBNATH	MURARI MOHAN DEBNATH	EAST KAMARTHUBA	OBC		Male	368605006739	
493.	6	SLUM	BIPLAB BANIK	ANIL KRISHNA BANIK	EAST KAMARTHUBA	GEN		Male	423905735755	
494.	6	SLUM	RANJAN SIL		EAST KAMARTHUBA	SC		Male	79211981037	
495.	6	SLUM	PARITOSH RAHA	LT. PARESH RAHA	EAST KAMARTHUBA	GEN		Male	955015464750	
496.	6	SLUM	CHAMPA HALDER	AMIYA HALDER	EAST KAMARTHUBA	SC		Female	738310106641	





Sl. No.	Ward No	Slum / Non Slum	Name of Beneficiary	Father's Name / Husband's Name	Holding No./ Address	Category		Gender	Aadhaar No.	Photo
						Gen/S.C./O.B.C./S.T	Minority			
497.	6	SLUM	BEAUTY PATRA	ASIT CHAKRABORTY	EAST KAMARTHUBA	SC		Female	798987155774	
498.	6	SLUM	ASIT SIL	NIRMAL SIL	EAST KAMARTHUBA	SC		Male	251647788683	
499.	6	SLUM	SHEFALI DAS	ARUP DAS	EAST KAMARTHUBA	SC		Female	249936300555	
500.	6	SLUM	SUMITRA DEBNATH	PRANKRISHNA DEBNATH	EAST KAMARTHUBA	GEN		Female	923698408904	
501.	6	SLUM	SHYAMALI DAS	RANJAN SAHA	EAST KAMARTHUBA	GEN		Female	222883172145	
502.	6	SLUM	BASU BANIK	BASANTA BANIK	EAST KAMARTHUBA	GEN		Male	542552888750	

Sl. No.	Ward No	Slum / Non Slum	Name of Beneficiary	Father's Name / Husband's Name	Holding No./ Address	Category		Gender	Aadhaar No.	Photo
						Gen/S.C./O.B.C./S.T	Minority			
503.	6	SLUM	ASIM SHIL	NIRMAL SIL	EAST KAMARTHUBA	SC		Male	549546896152	
504.	6	SLUM	SUBAL RANJAN SARKAR	CHANDI CHARAN SARKAR	EAST KAMARTHUBA	SC		Male	866096660432	
505.	6	SLUM	GOPAL DEY	RANJIT DEY	EAST KAMARTHUBA	GEN		Male	824357995239	
506.	6	SLUM	PRASANTA DEY	DILIP DEY	EAST KAMARTHUBA	GEN		Male	239539786778	
507.	6	SLUM	DINESH DEBNATH	BHUBAN DEBNATH	EAST KAMARTHUBA	GEN		Male	52068911846	
508.	6	SLUM	MANJU NAYAK		EAST KAMARTHUBA	GEN		Female	725219015616	





Sl. No.	Ward No	Slum / Non Slum	Name of Beneficiary	Father's name / Husband's Name	Holding No./ Address	Category		Gender	Aadhaar No.	Photo
						Gen/S.C./O.B.C./S.T	Minority			
509.	6	SLUM	NIMAI SARKAR	RADHYSHYAM SARKAR	EAST KAMARTHUBA	SC		Male	677437713851	
510.	6	SLUM	MAYNA BISWAS		EAST KAMARTHUBA	SC		Female	822544324364	
511.	6	SLUM	CHABI DUTTA	TARUN KANTI DUTTA	EAST KAMARTHUBA	GEN		Female	421841309056	
512.	6	SLUM	MILON TALUKDER	JOGESWAR TALUKDER	EAST KAMARTHUBA	SC		Male	610282304977	
513.	6	SLUM	BIKASH SARKAR	AMULYA SARKAR	EAST KAMARTHUBA	SC		Male	902218208528	
514.	6	SLUM	BIMAL DAS	BINOD BIHARI DAS	EAST KAMARTHUBA	SC		Male	962025885535	

Sl. No.	Ward No	Slum / Non Slum	Name of Beneficiary	Father's Name / Husband's Name	Holding No./ Address	Category		Gender	Aadhaar No.	Photo
						Gen/S.C./O.B.C./S.T	Minority			
515.	6	SLUM	SHANKAR BISWAS	KUMARESH BISWAS	EAST KAMARTHUBA	SC		Male	528190357652	
516.	6	SLUM	ABHA BISWAS	SHANTI RANJAN BISWAS	EAST KAMARTHUBA	SC		Female	513629975163	
517.	6	SLUM	NARAYAN SIL	KALIPADA SIL	EAST KAMARTHUBA	SC		Male	604879319572	
518.	6	Slum	GOPAL SAHA		Kamarthuba	Gen		Male	525692338664	
519.	6	Slum	SIBU GHOSH	NIRMAL KUMAR GHOSH	KAMARTHUBA	GEN		MALE	961335000227	

Sl. No.	Ward No	Slum / Non Slum	Name of Beneficiary	Father's Name / Husband's Name	Holding No./ Address	Category		Gender	Aadhaar No.	Photo
						Gen/S.C./O.B.C./S.T	Minority			
520.	6	Slum	TAPAS SAHA	GOUTAM SAHA	KAMARTHUBA	GEN		MALE	987244287974	
521.	6	Slum	KISHORE TAPADER	AJIT TAPADER	KAMARTHUBA	GEN		MALE	346833601388	
522.	6	Slum	ASHOK SIL	NIRMAL SIL	KAMAR THUBA	SC		MALE	823641790360	
523.	6	Slum	SABITA MONDAL	ASISH MONDAL	KAMARTHUBA	SC		FEMALE	622458242533	



Sl. No.	Ward No	Slum / Non Slum	Name of Beneficiary	Father's Name / Husband's Name	Holding No./ Address	Category		Gender	Aadhaar No.	Photo
						Gen/S.C./O.B.C./S.T	Minority			
524.	6	Slum	ASHOK BHOWMICK	NEPAL BHOWMICK	KAMARTHUBA	GEN		MALE	654407436310	
525.	6	Slum	RADHARANI DEY	AMULLYA ADITYA	KAMARTHUBA	GEN		FEMALE	438036923588	
526.	6	Slum	DIPANKAR SUR	J SUR	KAMARTHUBA	GEN		MALE	581982554025	
527.	7	SLUM AREA	PRASANTA DEBNATH	BIMAL DEBNATH	WEST KAMARTHUBA	GEN		Male	503099265167	



Sl. No.	Ward No	Slum / Non Slum	Name of Beneficiary	Father's Name / Husband's Name	Holding No./ Address	Category		Gender	Aadhaar No.	Photo
						Gen/S.C./O.B.C./S.T	Minority			
528.	7	SLUM AREA	BEAUTY SHARMA	JIBAN KRISHNA DEBNATH	WEST KAMARTHUBA	GEN		Female	251462315683	
529.	7	SLUM AREA	BUDDHADEB SHIL	PRADIP PAUL	WEST KAMARTHUBA	SC		Male	507577199528	
530.	7	SLUM AREA	UTTAM SHIL	BASUDEB SHIL	WEST KAMARTHUBA	SC		Male	239330841836	
531.	7	SLUM AREA	RAJU DAS	SUBAL DAS	WEST KAMARTHUBA	SC		Male	580489137709	

Sl. No.	Ward No.	Slum / Non Slum	Name of Beneficiary	Father's Name / Husband's Name	Holding No./ Address	Category		Gender	Aadhaar No.	Photo
						Gen/S.C./O.B.C./S.T.	Minority			
532.	7	SLUM AREA	ARCHANA DEBNATH	ANANTA DEBNATH	WEST KAMARTHUBA	GEN		Female	69914297621	
533.	7	SLUM AREA	KHOKON DAS	NARAYAN CH. DAS	WEST KAMARTHUBA	GEN		Male	328631592292	
534.	7	SLUM AREA	HARAN BISWAS	BARADA KANTA BISWAS	WEST KAMARTHUBA	SC		Male	704656571628	
535.	7	SLUM AREA	SANKAR DAS	CHITTARANJAN DAS	WEST KAMARTHUBA	SC		Male	980964106701	



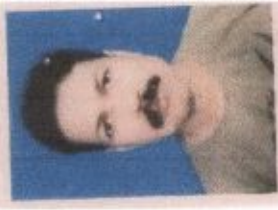

Sl. No.	Ward No	Slum / Non Slum	Name of Beneficiary	Father's Name / Husband's Name	Holding No./ Address	Category		Gender	Aadhaar No.	Photo
						Gen/S.C./O.B.C./S.T	Minority			
536.	7	SLUM AREA	ASHIM DAS	AKHIL DAS	WEST KAMARTHUBA	SC		Male	940390815866	
537.	7	SLUM AREA	DULAL DAS	PRIYARANJAN DAS	WEST KAMARTHUBA	SC		Male	973214302692	
538.	7	SLUM AREA	KESHITA KAHAR	KHOSO KAHAR	WEST KAMARTHUBA	SC		Male	378531857886	
539.	7	SLUM AREA	RATAN DEBNATH	GOPAL CH. DEBNATH	WEST KAMARTHUBA	GEN		Male	476618059989	

Sl. No.	Ward No	Slum / Non Slum	Name of Beneficiary	Father's Name / Husband's Name	Holding No./ Address	Category		Gender	Aadhaar No.	Photo
						Gen/S.C./O.B.C./S.T	Minority			
540.	7	SLUM AREA	KANAK BARUI	SARAT MANDAL	WEST KAMARTHUBA	SC		Female	779646202338	
541.	7	SLUM AREA	USHA SIKDER	NITYANANDA MONDAL	WEST KAMARTHUBA	SC		Female	973842322140	
542.	7	SLUM AREA	DULAL HALDER	NITYANANDA HALDER	WEST KAMARTHUBA	SC		Male	775903523384	
543.	7	SLUM AREA	MITHUN CHATTERJEE	FANI BHUSAN CHATTERJEE	WEST KAMARTHUBA	GEN		Male	330434288334	





Sl. No.	Ward No.	Slum / Non Slum	Name of Beneficiary	Father's Name / Husband's Name	Holding No./ Address	Category		Gender	Aadhaar No.	Photo
						Gen/S.C./O.B.C./S.T.	Minority			
544.	7	SLUM AREA	ASISH SAHA	AJIT SAHA	WEST KAMARTHUBA	GEN		Male	795109683009	
545.	7	SLUM AREA	BISWAJIT SINGHA	SASHI BHUSAN SINGHA	WEST KAMARTHUBA	GEN		Male	612161827118	
546.	7	SLUM AREA	RAMU SINGHA	RATAN SINGH	WEST KAMARTHUBA	GEN		Male	732615406440	
547.	7	SLUM AREA	TANUSHRI DEY	NARAYAN CH. DAS	WEST KAMARTHUBA	GEN		Female	386367509169	



Sl. No.	Ward No	Slum / Non Slum	Name of Beneficiary	Father's Name / Husband's Name	Holding No./ Address	Category		Gender	Aadhaar No.	Photo
						Gen/S.C./O.B.C./S.T	Minority			
548.	7	SLUM AREA	KAMALA MONDAL	PURNA CH. MONDAL	WEST KAMARTHUBA	SC		Female	954204269797	
549.	7	SLUM AREA	SAMIR DEY	MANINDRA DEY	WEST KAMARTHUBA	GEN		Male	759847129928	
550.	7	SLUM AREA	KALYANI DAS	BALARAM DAS	WEST KAMARTHUBA	GEN		Female	367460882192	
551.	7	SLUM AREA	SHIKHA DHALI	DULAL BRAHMA	WEST KAMARTHUBA	GEN		Female	724628827302	





Sl. No.	Ward No	Slum / Non Slum	Name of Beneficiary	Father's Name / Husband's Name	Holding No./ Address	Category		Gender	Aadhaar No.	Photo
						Gen/S.C./O.B.C./S.T	Minority			
552.	7	SLUM AREA	ARATI SAHA	ANIL SAHA	WEST KAMARTHUBA	GEN		Female	451587152522	
553.	7	SLUM AREA	DEBU BISWAS	DIPAK BISWAS	WEST KAMARTHUBA	SC		Male	691995082496	
554.	7	SLUM AREA	NANI GOPAL SAHA	KARTICK CH. SAHA	WEST KAMARTHUBA	GEN		Male	641322619076	



Sl. No.	Ward No	Slum / Non Slum	Name of Beneficiary	Father's Name / Husband's Name	Holding No./ Address	Category		Gender	Aadhaar No.	Photo
						Gen/S.C./O.B.C./S.T	Minority			
555.	7	SLUM AREA	RAMA SAHA	ANANTA SAHA	WEST KAMARTHUBA	GEN		Female	807790461755	
556.	7	SLUM AREA	MILAN RAY	ATUL CH. RAY	WEST KAMARTHUBA	GEN		Male	279961479751	
557.	7	SLUM AREA	NIHAR RANJAN CHOWDHURY	NIL RATAN CHOWDHURY	WEST KAMARTHUBA	GEN		Male	739925603196	
558.	7	SLUM AREA	MANAS MONDAL	BHUPENDRA NATH MONDAL	WEST KAMARTHUBA	SC		Male	715952722269	





Sl. No.	Ward No	Slum / Non Slum	Name of Beneficiary	Father's Name / Husband's Name	Holding No./ Address	Category		Gender	Aadhaar No.	Photo
						Gen/S.C./O.B.C./S.T	Minority			
559.	7	SLUM AREA	SUMAN DHARA	SHIBNATH DHARA	WEST KAMARTHUBA	GEN		Male	9770123143107	
560.	7	SLUM AREA	HARAN KAHAR	SATISH KAHAR	WEST KAMARTHUBA	SC		Male	514686424005	
561.	7	SLUM AREA	DURGAPRASAD PAL	SUBODH PAL	WEST KAMARTHUBA	OBC		Male	562030258484	
562.	7	SLUM AREA	NIL RATAN SAHA	NITAI PADA SAHA	WEST KAMARTHUBA	GEN		Male	866447859492	

Sl. No.	Ward No	Slum / Non Slum	Name of Beneficiary	Father's Name / Husband's Name	Holding No./ Address	Category		Gender	Aadhaar No.	Photo
						Gen/S.C./O.B.C./S.T	Minority			
563.	7	SLUM AREA	MINATI MONDAL	PARIMAL MONDAL	WEST KAMARTHUBA	SC		Female	785414597459	
564.	7	SLUM AREA	SUNIL CHAKRABORTY	HARADHAN CHAKRABORTY	WEST KAMARTHUBA	GEN		Male	578680966106	
565.	7	SLUM AREA	DEBABRATA ROY	AMULYA CH. ROY	WEST KAMARTHUBA	GEN		Male	849651750852	

Sl. No.	Ward No	Slum / Non Slum	Name of Beneficiary	Father's name / Husband's Name	Holding No./ Address	Category		Gender	Aadhaar No.	Photo
						Gen/S.C./O.B.C./S.T	Minority			
566.	7	SLUM AREA	TOTAN DHALI	RANJIT DHALI	WEST KAMARTHUBA	GEN		Male	710604165726	
567.	7	SLUM AREA	ARATI SARKAR	BIJOY KRISHNA SARKAR	WEST KAMARTHUBA	SC		Female	777075408280	
568.	7	SLUM AREA	DEBABRATA MONDAL	DIPAK MONDAL	WEST KAMARTHUBA	SC		Male	779693082151	
569.	7	SLUM AREA	BIPUL SAHA	NITYANANDA SAHA	WEST KAMARTHUBA	GEN		Male	580750763771	





Sl. No.	Ward No	Slum / Non Slum	Name of Beneficiary	Father's name / Husband's Name	Holding No./ Address	Category		Gender	Aadhaar No.	Photo
						Gen/S.C./O.B.C./S.T	Minority			
570.	7	SLUM AREA	SAMIR KUNDU	SANTIPADA KUNDU	WEST KAMARTHUBA	OBC		Male	480465851494	
571.	7	SLUM AREA	GITA ROY	MANINDRA DEBNATH	WEST KAMARTHUBA	GEN		Female	782338688885	
572.	7	SLUM AREA	TILAK DAS	SHYAM DAS	WEST KAMARTHUBA	GEN		Male	356427822877	
573.	7	SLUM AREA	BELA DAS	PARESH CH. CHANDA	WEST KAMARTHUBA	GEN		Female	971010886028	





Sl. No.	Ward No	Slum / Non Slum	Name of Beneficiary	Father's Name / Husband's Name	Holding No./ Address	Category		Gender	Aadhaar No.	Photo
						Gen/S.C./O.B.C./S.T	Minority			
574.	7	SLUM AREA	MALA BASU ROY CHOWDHURY	SHANTI RANJAN DUTTA CHOWDHURY	WEST KAMARTHUBA	GEN		Female	659207980955	
575.	7	SLUM AREA	DHIMAN KANTI BISWAS	BIRENDRA NATH BISWAS	WEST KAMARTHUBA	SC		Male	746054047763	
576.	7	SLUM AREA	ANUP DAS	ARUN KUMAR DAS	WEST KAMARTHUBA	GEN		Male	335659812481	
577.	7	SLUM AREA	CHOTAI SINGHA	RATAN SINGHA	WEST KAMARTHUBA	GEN		Male	464977471298	

Sl. No.	Ward No	Slum / Non Slum	Name of Beneficiary	Father's Name / Husband's Name	Holding No./ Address	Category		Gender	Aadhaar No.	Photo
						Gen/S.C./O.B.C./S.T	Minority			
578.	7	SLUM AREA	BAPI SHIL	BASUDEB SHIL	WEST KAMARTHUBA	SC		Male	598468627976	
579.	7	SLUM AREA	SUMITA SEN	NANDA DULAL KAR	WEST KAMARTHUBA	GEN		Female	700287210334	
580.	7	SLUM AREA	DEBENDRA NATH MONDAL	FATIK CHAND MONDAL	WEST KAMARTHUBA	SC		Male	399219097155	

Sub-Assistant Engineer
HABRA MUNICIPALITY

Sl. No.	Ward No	Slum / Non Slum	Name of Beneficiary	Father's Name / Husband's Name	Holding No./ Address	Category		Gender	Aadhaar No.	Photo
						Gen/S.C./O.B.C./S.T	Minority			
581.	7	SLUM AREA	JHANTU DAS	PRAFULLA DAS	WEST KAMARTHUBA	SC		Male	818595001800	
582.	7	SLUM AREA	PAMPA MONDAL	SUJAN MONDAL	WEST KAMARTHUBA	SC		Female	730398819403	
583.	7	SLUM AREA	ARUN KUNDU	KHAGEN KUNDU	WEST KAMARTHUBA	OBC		Male	295015099962	
584.	7	SLUM AREA	SABITA SINGH	SIBNATH SINGH	WEST KAMARTHUBA	GEN		Female	501260268550	

Sl. No.	Ward No	Slum / Non Slum	Name of Beneficiary	Father's name / Husband's Name	Holding No./ Address	Category		Gender	Aadhaar No.	Photo
						Gen/S.C./O.B.C./S.T	Minority			
585.	7	SLUM AREA	ARABINDA SAHA	ABINASH CH. SAHA	WEST KAMARTHUBA	GEN		Male	737494268161	
586.	7	SLUM AREA	MONI SADHU	ADHIR DUTTA	WEST KAMARTHUBA	GEN		Female	245354345445	
587.	7	SLUM AREA	SUJATA DEBNATH	HIRALAL DEBNATH	WEST KAMARTHUBA	GEN		Female	854330827739	
588.	7	SLUM AREA	SUBHASH DEY	SATYENDRA NATH DEY	WEST KAMARTHUBA	GEN		Male	420309365804	







Sl. No.	Ward No	Slum / Non Slum	Name of Beneficiary	Father's Name / Husband's Name	Holding No./ Address	Category		Gender	Aadhaar No.	Photo
						Gen/S.C./O.B.C./S.T	Minority			
589.	7	SLUM AREA	PRASANTA BASU	DHIRENDRA NATH BASU	WEST KAMARTHUBA	GEN		Male	498452532163	
590.	7	SLUM AREA	SANJIB KUMAR DEY	SATYENDRA NATH DEY	WEST KAMARTHUBA	GEN		Male	797984408794	
591.	7	SLUM AREA	MADHURI DEY	SUJAY KANTA MONDAL	WEST KAMARTHUBA	GEN		Female	993159343707	
592.	7	SLUM AREA	PRAKASH ROY	SUDHIR ROY	WEST KAMARTHUBA	GEN		Male		







Sl. No.	Ward No	Slum / Non Slum	Name of Beneficiary	Father's Name / Husband's Name	Holding No./ Address	Category		Gender	Aadhaar No.	Photo
						Gen/S.C./O.B.C./S.T	Minority			
593.	7	SLUM AREA	GITA DEY	RADHESHYAM BISWAS	WEST KAMARTHUBA	GEN		Female	520281546539	
594.	7	SLUM AREA	TAPASI SARDER ROY	KALI PADA ROY	WEST KAMARTHUBA	GEN		Female	689476703013	
595.	7	SLUM AREA	JOSHNA ROY	KISHORI MOHAN SAHA	WEST KAMARTHUBA	GEN		Female	310730284451	
596.	7	SLUM AREA	MEPAL DEBNATH	GIRINDRA DEBNATH	WEST KAMARTHUBA	GEN		Male	493052032242	
597.	7	SLUM AREA	BIMAN SARKAR	GOSTA SARKAR	WEST KAMARTHUBA	SC		Male	464141475995	

Sl. No.	Ward No	Slum / Non Slum	Name of Beneficiary	Father's name / Husband's Name	Holding No./ Address	Category		Gender	Aadhaar No.	Photo
						Gen/S.C./O.B.C./S.T	Minority			
598.	7	SLUM AREA	SILPI CHAKRABORTY	SATYA CHAKRABORTY	WEST KAMARTHUBA	GEN		Female	687315740357	
599.	7	SLUM AREA	TARAK SARKAR	LALIT SARKAR	WEST KAMARTHUBA	OBC		Male	258247285906	
600.	7	SLUM AREA	KAJALI SARKAR	NARAYAN DAS	WEST KAMARTHUBA	OBC		Female	775086721425	
601.	7	SLUM AREA	BISHWA BANIK	KAMALA BANIK	WEST KAMARTHUBA	GEN		Male	687661217480	
602.	8	Slum	Jagadish Chandra Gayen	Satish Chandra Gayen	Netaji Nagar, North Habra	Genarel		Male	445256803969	

[Signature]

Sub-Assistant Engineer
HABRA MUNICIPALITY

Sl. No.	Ward No	Slum / Non Slum	Name of Beneficiary	Father's Name / Husband's Name	Holding No./ Address	Category		Gender	Aadhaar No.	Photo
						Gen/S.C./O.B.C./S.T.	Minority			
603.	8	Slum	Namita Shil	Aswini Shil	Netaji Nagar, North Habra	Genarel		Female	364243330265	
604.	8	Slum	Namita Bhagat	Binod Halder	Netaji Nagar, North Habra	Genarel		Female	568450341025	
605.	8	Slum	Binata Baral	Maharaj Mistry	Netaji Nagar, North Habra	Genarel		Female	966887497319	
606.	8	Slum	Swapan Das	Biren Kumar Das	Netaji Nagar, North Habra	Genarel		Male	243825988584	
607.	8	Slum	Gouranga patikar	Bijoy Krishna Patikar	Netaji Nagar, North Habra	Genarel		Male	707886512825	
608.	8	Slum	Dilip Halder	Biren Halder	Netaji Nagar, North Habra	Genarel		Male	301589071534	





Sl. No.	Ward No	Slum / Non Slum	Name of Beneficiary	Father's Name / Husband's Name	Holding No./ Address	Category		Gender	Aadhaar No.	Photo
						Gen/S.C./O.B.C./S.T	Minority			
609.	8	Slum	Raju sarkar	Narayan Chandra sarkar	Netaji Nagar, North Habra	Sc		Male	783087403408	
610.	8	Slum	Ajit Dey	Santosh Ranjan Dey	Netaji Nagar, North Habra	General		Male	210526083767	
611.	8	Slum	Anup Sikder	Anil Sikder	Netaji Nagar, North Habra	General		Male	505482742765	
612.	8	Slum	Kala Das	Fulchand Das	Netaji Nagar, North Habra	General		Male	350345127995	
613.	8	Slum	Tapas Cahndar Adhikary	Chandra Nath Adhikary	Netaji Nagar, North Habra	General		Male	647293381883	
614.	8	Slum	Bimal Das	Fatik Das	Netaji Nagar, North Habra	General		Male	814555797259	

AM

Sub-Assistant Engineer
HABRA MUNICIPALITY





Sl. No.	Ward No	Slum / Non Slum	Name of Beneficiary	Father's Name / Husband's Name	Holding No./ Address	Category		Gender	Aadhaar No.	Photo
						Gen/S.C./O.B.C./S.T	Minority			
615.	8	Slum	Jaba saha	Narayan Chandra saha	Netaji Nagar, North Habra	General		Female	242267591944	
616.	8	Non Slum	Abhijit Biswas	Shyamal Biswas	Staffquarter	Sc		Male	200366331289	
617.	8	Non Slum	Ashis Kar	Sushil Kar	United Club Goli	General		Male	404107575839	
618.	8	Non Slum	Mahadeb Natta	Ballav Natta	United Club Goli	General		Male	630491294999	

Sl. No.	Ward No	Slum / Non Slum	Name of Beneficiary	Father's Name / Husband's Name	Holding No./ Address	Category		Gender	Aadhaar No.	Photo
						Gen/S.C./O.B.C./S.T	Minority			
619.	8	Non Slum	Ripan Debnath	Jatindra Debnath	United Club Goli	General		Male	848426442825	
620.	8	Non Slum	Kalpna Deb	Satish Chandra Deb	United Club Goli	General		Female	43017446391	
621.	8	Non Slum	Bishnu Kundu	Jagannath Kundu	United Club Goli	General		Male	588642585373	
622.	8	Non Slum	Parul Saha	Nikhil Sarkar	United Club Goli	General		Female	514725369869	
623.	8	Non Slum	Sujata Roy	Amulla Roy	United Club Goli	General		Female	374703877222	
624.	8	slum	Jaba Ghosh	Swapan Dutta	Lokenath Colony	General		Female	738301571591	

Sl. No.	Ward No	Slum / Non Slum	Name of Beneficiary	Father's Name / Husband's Name	Holding No./ Address	Category		Gender	Aadhaar No.	Photo
						Gen/S.C./O.B.C./S.T	Minority			
625.	8	Non Slum	Chandra Das	Pravash Das	United Club Goli	General		Female	639014044640	
626.	8	Slum	Minati Gharami	Goutam Gharami	Lelin sarani	General		Female	768861071723	
627.	8	Slum	Fatik Barui	Janardhan Barui	Lelin Nagar	Sc		Male	570126083746	
628.	8	Slum	Alo Rani Mondal	Babul Mondal	Lelin Nagar	Sc		Female	912213231845	
629.	8	Slum	Sunil Shil	Ashwini Shil	Lelin Nagar	OBC		Male	7444850460262	
630.	8	Non Slum	Kalpana Das	Sudhir Das	Post Office Road	General		Female	200791734085	

Sl. No.	Ward No	Slum / Non Slum	Name of Beneficiary	Father's Name / Husband's Name	Holding No./ Address	Category		Gender	Aadhaar No.	Photo
						Gen/S.C./O.B.C./S.T	Minority			
631.	8	Slum	Chabi das	Nimai shil	Lokenath Sarani	General		Female	611832476671	
632.	8	Slum	Biswanath Halder	Sunil Halder	Lelin Nagar	General		male	710860961588	
633.	8	Non Slum	Shipra sarkar	Baidyanath Biswas	Post Office Road	General		Female	546097600856	
634.	8	Slum	Minati Saha	Sanjib Saha	Lokenath sarani	General		Female	377757171065	
635.	8	Non Slum	Anil Dutta	Jatindranath Dutta	United Club Goli	General		Male	888560745323	
636.	8	Slum	Bhaskar Biswas	Subal Biswas	Netraji Nagar	Sc		Male	854009293805	



[Signature]

Sl. No.	Ward No	Slum / Non Slum	Name of Beneficiary	Father's Name / Husband's Name	Holding No./ Address	Category		Gender	Aadhaar No.	Photo
						Gen/S.C./O.B.C./S.T	Minority			
637.	8	Non Slum	Biswajit Chakraborty	Dilip Chakraborty	Staffquarter	General		Male	906675234076	
638.	8	Slum	Akhil Ghosh	Anil Ghosh	Lelin Nagar	general		male	667710114701	
639.	8	Non Slum	Maya Rani Das	Baydhanath sadhu	United Club Gali	General		Female	314414935714	
640.	8	Slum	Samir Biswas	Khirode Biswas	Lelin Nagar	Sc		Male	961115259280	
641.	8	Non Slum	Ratna Saha	Khitesh Chandra saha	Post Office Road	General		Female	289798405122	
642.	8	Non Slum	Tushar Mukherjee	Ranjit Mukherjee	Staffquarter	General		Male	261758125970	

Sl. No.	Ward No	Slum / Non Slum	Name of Beneficiary	Father's name / Husband's Name	Holding No./ Address	Category		Gender	Aadhaar No.	Photo
						Gen/S.C./O.B.C./S.T	Minority			
643.	8	Non Slum	Barun Dey	Manindra Nath Dey	North Habra	General		Male	254924752406	
644.	8	Non Slum	Pratima Nath	Narayan Chandra Nath	Staffquarter	General		Female	897802525952	
645.	8	Slum	Mukta Das	Ranjit Saha	Lokenath Colony	General		Female	390711393591	
646.	8	Slum	Rinku Das	Chittaranjan Biswas	Lokenath Colony	General		Female	285995576256	
647.	8	Slum	Ujjal Dhali	Anil Dhali	Netaji Nagar	General		Male	466030455310	

Sl. No.	Ward No	Slum / Non Slum	Name of Beneficiary	Father's Name / Husband's Name	Holding No./ Address	Category		Gender	Aadhaar No.	Photo
						Gen/S.C./O.B.C./S.T	Minority			
										
648.	8	Slum	Samir Barman	Santosh Barman	Parui Para	General		Male	215887064004	
649.	8	Non Slum	Alorani Dey	Bhupen Dutta	United Club Goli	General		Female	722310674655	
650.	8	Non Slum	Shanti Roy	Panchanan Roy	North Habra	General		Female	279009099845	
651.	8	Slum	Malati sarkar	Yogesh samadder	Parui Para	General		Female	213060425645	
652.	8	Slum	Bholanath Dutta	Kashinath Dutta	Lokenath Colony	General		Male	436100343474	

[Signature]

Sl. No.	Ward No	Slum / Non Slum	Name of Beneficiary	Father's Name / Husband's Name	Holding No./ Address	Category		Gender	Aadhaar No.	Photo
						Gen/S.C./O.B.C./S.T	Minority			
653.	8	Slum	Minu Saha	Jogendra Nath Saha	Lelin Nagar	General		Female	934808558133	
654.	8	SLUM	MAMPI ROY	NARAYAN ROY	NEHRUBAG	SC		FEMALE	951405393132	
655.	8	Slum	SHILPI MONDAL	NARAYAN MONDAL	NORTH HABRA	SC		FEMALE	374493934032	
656.	8	Slum	Krishna kanta roy	Sashi kumar roy	Post office road	Sc		Male	723595627835	
657.	9	Slum	BIMAN KUMAR MODAK	AMULYA CHANDRA MODAK	Sripur Purba Para	General		Male	910668834028	
658.	9	Slum	ARCHANA PODDAR	SANTI RANJAN PODDAR	Sripur Purba Para	General		Female	476821360464	

Sl. No.	Ward No	Slum / Non Slum	Name of Beneficiary	Father's name / Husband's Name	Holding No./ Address	Category		Gender	Aadhaar No.	Photo
						Gen/S.C./O.B.C./S.T	Minority			
659.	9	Slum	KANCHAN SAHA	KASHINATH SAHA	Sripur Purba Para	General		Male	927304136116	
660.	9	Slum	ANIMA MAJUMDAR	PURNA CHANDRA MAJUMDAR	Sripur Purba Para	General		Female	572438550465	
661.	9	Slum	BHARAT SAHA	HARIPADA SAHA	Sripur Purba Para	General		Male	928424561130	
662.	9	Slum	UTTAM PAL	RANJIT PAL	Sripur Purba Para	General		Male	991467917060	
663.	9	Non Slum	MILI SAHA	RANJAN SADU		General		Female	390863366468	
664.	9	Non Slum	MANIK PODDER	DEBESH CHANDRA PODDER		General		Male	306358294305	
665.	9	Non Slum	PINKI KARMAKAR SADHU	RANJAN KUMAR SADHU		General		Female	730177978943	
666.	9	Non Slum	SUBRATA BANIK	SUKHARANJAN BANIK		General		Male	822001186083	



Sub-Assistant Engineer
HABRA MUNICIPALITY

Sl. No.	Ward No	Slum / Non Slum	Name of Beneficiary	Father's Name / Husband's Name	Holding No./ Address	Category		Gender	Aadhaar No.	Photo
						Gen./S.C./O.B.C./S.T	Minority			
667.	9	Non Slum	SANJAY DAS	HIRALAL DAS		General		Male	589144622173	
668.	9	Non Slum	SANKAR BHOWMICK	KAJAL CHANDRA BHOWMICK		General		Male	870968224194	
669.	9	Non Slum	SANJAY KUNDU	NITYANANDA KUNDU		General		Male	472218388135	
670.	9	Non Slum	SURAJIT PAUL	RANAJIT PAUL		General		Male	328538322695	
671.	9	Slum	GITA SAHA	ANIL KUMAR SAHA	Sripur Mathpara	General		Female	524311897218	
672.	9	Non Slum	SURESH KANSA BANIK	BIRESHWAR KANSA BANIK		General		Male	715520408202	
673.	9	Non Slum	SANJAY KARMAKAR	KHOKAN KARMAKAR		General		Male	416203942386	
674.	9	Slum	GOUTAM DAS	NIRMAL CHANDRA DAS	Sripu Paschim Para	General		Male	420531927230	

Sub-Assistant Engineer
HABRA MUNICIPALITY



Sl. No.	Ward No	Slum / Non Slum	Name of Beneficiary	Father's Name / Husband's Name	Holding No./ Address	Category		Gender	Aadhaar No.	Photo
						Gen./S.C./O.B.C./S.T	Minority			
675.	9	Non Slum	SAMIR SAHA	GOUR CHANDRA SAHA		General		Male	610359573657	
676.	9	Non Slum	PALASH DUTTA	RANGALAL DUTTA		General		Male	600036175005	
677.	9	Non Slum	PALTU SARKAR	SUNIL SARKAR		General		Male	561211225947	
678.	9	Slum	JULI CHANDRA	SADHAN CHANDRA	Sripur Purba Para	General		Female	700021508670	
679.	9	Slum	PRASENJIT SAHA	SHANTI RANJAN SAHA	Sripur Purba Para	General		Male	249477423618	
680.	9	Slum	PRANKRISHNA GHOSH	JAGADISH GHOSH	Sripur Purba Para	General		Male	700048385057	
681.	9	Slum	NIMAY GHOSH	JAGODISA CHANDRA GHOSH	Sripur Purba Para	General		Male	263598886058	
682.	9	Slum	SAMEN SARKAR	RAKHAL CHANDRA SARKAR	Sripur Purba Para	General		Male	923085642806	

Sl. No.	Ward No	Slum / Non Slum	Name of Beneficiary	Father's Name / Husband's Name	Holding No./ Address	Category		Gender	Aadhaar No.	Photo
						Gen/S.C./O.B.C./S.T	Minority			
683.	9	Slum	PRABIR PANDEY	PRABHAT PANDEY	Sripur Purba Para	General		Male	213918492317	
684.	9	Slum	SIKHA DAS	SADANANDA DASGUPTA	Sripur Purba Para	General		Female	414028504212	
685.	9	Slum	AKSHAY SARDAR	GOPAL HALDER	Sripur Purba Para	General		Male	872979495177	
686.	9	Slum	PRASANTA BANIK	SUKHARANJAN BANIK	Sripur Purba Para	General		Male	652379795167	
687.	9	Slum	SAMIR PANDEY	PRABHAT PANDEY	Sripur Purba Para	General		Male	489919043933	
688.	9	Non Slum	KHUKU RANI BISWAS	HAREN CHANDRA BHOWMIK		General		Female	990919296579	
689.	9	Slum	DEBJIT PAUL	ASHIM PAUL	Sripur Purba Para	General		Male	221652671418	
690.	9	Non Slum	SWAPAN KUMAR PAUL	BABURAM PAUL		General		Male	983977983544	

Sl. No.	Ward No	Slum / Non Slum	Name of Beneficiary	Father's Name / Husband's Name	Holding No./ Address	Category		Gender	Aadhaar No.	Photo
						Gen/S.C./O.B.C./S.T	Minority			
691.	9	Non Slum	TAPAN KUMAR PAUL	BABURAM PAUL		General		Male	436003079502	
692.	9	Non Slum	SUSHANTO KUMAR DAS			General		Male	922164367257	
693.	9	Non Slum	JAYASRI BOSE BASU	SWAPAN BASU		General		Female	729279757725	
694.	9	Non Slum	SUBODH KUMAR BANIK	SHAKTI PADA BANIK		General		Male	827555892983	
695.	9	Slum	KRISHNA PADA SARKAR	PRAFULLA SARKAR	Sripur Ghatak Para	General		Male	237175822128	
696.	9	Slum	SHYAMAL DEBNATH	HIRALAL DEBNATH	Sripur Ghatak Para	General		Male	409524323840	
697.	9	Slum	NAMITA DUTTA	KALIPADA DUTTA	Sripur Mathpara	General		Female	738413053721	
698.	9	Slum	SWAPNA DEBNATH	MADHUSADAN DEBNATH	Sripur Ghatak Para	General		Female	470879264258	

Sl. No.	Ward No	Slum / Non Slum	Name of Beneficiary	Father's Name / Husband's Name	Holding No./ Address	Category		Gender	Aadhaar No.	Photo
						Gen/S.C./O.B.C./S.T	Minority			
699.	9	Non Slum	SUMAN SINGHA	SUBHASH SINGHA		General		Male	526623981953	
700.	9	Slum	ARATI KARMAKAR	JITENDRA GHOSH	Sripur Ghatak Para	General		Female	226126775867	
701.	9	Slum	ASHOKE DEBNATH	NARENDRA NATH DEBNATH	Sripur Ghatak Para	General		Male	415226304278	
702.	9	Slum	ASHIS BISWAS	LT MANINDRA BISWAS	SREEPUR	General		Male	728272338682	
703.	9	Slum	BASUDEV SAHA	LATE, TARAK SAHA	SREEPUR	General		Male	819378899532	
704.	9	Non Slum	CHAITANYA ROY	LATE, KALIPADA ROY	SREEPUR	General		Male	994754024871	
705.	9	Slum	DURGA PADA BAIN	MUKUNDA BAIN	SREEPUR	SC		Male	478447176266	

Sl. No.	Ward No	Slum / Non Slum	Name of Beneficiary	Father's Name / Husband's Name	Holding No./ Address	Category		Gender	Aadhaar No.	Photo
						Gen/S.C./O.B.C./S.T	Minority			
706.	9	Slum	FANJIDAS	LATE-SANTOSH DAS	SREEPUR	SC		Male	512560486443	
707.	9	Slum	GOBARDHAN SEN	LATE, NARAYAN SEN	SREEPUR	General		Male	371090636461	
708.	9	Slum	GOKUL GOSWAMI	ASIT RANJAN GOSWAMI	SREEPUR	General		Male	229137895348	
709.	9	Non Slum	GOUTAM SAHA	LT HARIPADA SAHA	SREEPUR	General		Male	448699684785	
710.	9	Slum	KAMAL BALA	SUDHIR BALA	SREEPUR	General		Male	736567652343	
711.	9	Slum	PALASH ADHIKARI	LATE, HARIPADA ADHIKARI	SREEPUR	General		Male	615613166794	

Sl. No.	Ward No	Slum / Non Slum	Name of Beneficiary	Father's Name / Husband's Name	Holding No./ Address	Category		Gender	Aadhaar No.	Photo
						Gen/S.C./O.B.C./S.T	Minority			
712.	9	Slum	RAJESH MANDAL	MONARANJAN MANDAL	SREEPUR	General		Male	541756652938	
713.	9	Slum	SANTI MALLICK	LT SUREN MALLICK	SREEPUR	General		Female	711152507395	
714.	9	Slum	SUBHASH DAS	LATE, NAKUL DAS	SREEPUR	General		Male	412934590307	
715.	9	Slum	SUSANTA DAS	DURGA DAS	SREEPUR	General		Male	346935449370	
716.	9	Slum	Shekhar rakshit	Bidesh rakshit	SREEPUR	General		Male	241340483243	
717.	9	Slum	URMILA SHIKARI	NITYANANDA SHIKARI	SREEPUR	SC		Female	734778091234	

Sl. No.	Ward No	Slum / Non Slum	Name of Beneficiary	Father's Name / Husband's Name	Holding No./ Address	Category		Gender	Aadhaar No.	Photo
						Gen/S.C./O.B.C./S.T	Minority			
718.	9	Slum	NARAYAN CHANDRA GHOSH	LT SHYAMAL GHOSH	SREEPUR	General		Male	879027837784	
719.	9	Slum	RATAN KARMAKAR	JOGENDRA NATH KARMAKAR	SREEPUR	General		Male	656256051401	
720.	9	Slum	Krishna dey	Paritosh dey	Sreepur	GEN		Male	367503416905	
721.	10	SLUM	KANANBALA ADHIKARI	JITENDRA ADHIKARY	S.V. Road	SC		FEMALE	373369776518	
722.	10	SLUM	SANJOY BISWAS	SUSHANTA BISWAS	RAMKRISHNA SARANI BY LANE	SC		MALE	381310289934	
723.	10	SLUM	NETAI BANIK	BIJOYKRISHNA BANIK	RAMKRISHNA SARANI	GENERAL		MALE	503344550938	
724.	10	SLUM	RATAN BASU	SHYAMAL BASU	S.V. Road	GENERAL		MALE	765645698252	

Sl. No.	Ward No	Slum / Non Slum	Name of Beneficiary	Father's Name / Husband's Name	Holding No./ Address	Category		Gender	Aadhaar No.	Photo
						Gen's.C./O.B.C./S.T	Minority			
725.	10	SLUM	PRABIR SAHA	MADHUSUDAN SAHA	RAMKRISHNA SARANI	GENERAL		MALE	990753406467	
726.	10	SLUM	SANTA KUNDU	RADHESHYAM KUNDU	RAMKRISHNA SARANI	GENERAL		MALE	291686387246	
727.	10	SLUM	BABI BISWAS	SHANTI BISWAS	S.V. Road	SC		MALE	848493609625	
728.	10	SLUM	SATI MAJUMDER	BHABARANJAN MAJUMDER	BARALIA ROAD.	GENERAL		FEMALE	384092760595	
729.	10	SLUM	BASUDEB SAHA	MANASA CHANDRA SAHA	RAMKRISHNA SARANI	GENERAL		MALE	685060893052	
730.	10	SLUM	TARUN ADHIKARY	KALIPADA ADHIKARY	S.V. Road	SC		MALE	295637291912	
731.	10	SLUM	TARAK PAUL	BIJAY KRISHNA PAUL	RAMKRISHNA SARANI	OBC		MALE	713423405732	
732.	10	SLUM	MAMINI ADHIKAI CHAKRABARTY	SADHAN ADHIKARI	S.V. Road	SC		FEMALE	724848514890	

Sl. No.	Ward No	Slum / Non Slum	Name of Beneficiary	Father's Name / Husband's Name	Holding No./ Address	Category		Gender	Aadhaar No.	Photo
						Gen/S.C./O.B.C./S.T	Minority			
733.	10	SLUM	SUJIT BANIK	NANIGOPAL BANIK	RAMKRISHNA SARANI	GENERAL		MALE	826665971708	
734.	10	SLUM	BASUDEV SAHA	SUBAL SAHA	BARALIA ROAD.	GENERAL		MALE	961851760857	
735.	10	SLUM	BASUDEB DUTTA BANIK	CHITTA RANJAN DUTTA BANIK	RAMKRISHNA SARANI	GENERAL		MALE	945872688715	
736.	10	SLUM	CHITTARANJAN HALDER	KHAGENDRA NATH HALDER	RAMKRISHNA SARANI	SC		MALE	707720672645	
737.	10	SLUM	SOURAV MONDAL	BHOLANATH MONDAL	RAMKRISHNA SARANI	SC		MALE	733722191921	
738.	10	SLUM	PRAKASH KUNDU	BIMAL KUNDU	SREENAGAR H.S. ROAD	GENERAL		MALE	314725341694	
739.	10	SLUM	AJIT PAUL	BHABARANJAN MAJUMDER	RAMKRISHNA ROAD.	GENERAL		MALE	497232116274	
740.	10	SLUM	SOMNATH BANIK	BIJAY KRISHNA BANIK	RAMKRISHNA ROAD.	GENERAL		MALE	913274730863	

Sl. No.	Ward No	Slum / Non Slum	Name of Beneficiary	Father's Name / Husband's Name	Holding No./ Address	Category		Gender	Aadhaar No.	Photo
						Gen/S.C./O.B.C./S.T	Minority			
741.	10	SLUM	LALITA KARMAKAR	DILIP KARMAKAR	RAMKRISHNA ROAD.	GENERAL		FEMALE	621323685079	
742.	10	SLUM	SUJATA BARUI	SANJIB BARUI	RAMKRISHNA ROAD.	OBC		FEMALE	868740539242	
743.	10	SLUM	BARUN ADHIKARI	ADHIR ADHIKARI	SREENAGAR H.S. ROAD	SC		MALE	262001923926	
744.	10	SLUM	KANAN BISWAS	LAXMAN BISWAS	RAMKRISHNA ROAD.	SC		FEMALE	985028863565	
745.	10	SLUM	SANJOY ROY	ANATH ROY	RAMKRISHNA SARANI	SC		MALE	272440233890	
746.	10	SLUM	JAYANTI GHOSH	ANJAN GHOSH	RAMKRISHNA ROAD.	GENERAL		FEMALE	787619485639	
747.	10	SLUM	RANJIT SAHA	MUKUNDA LAL SAHA	S.V. Road	GENERAL		MALE	698432641244	
748.	10	SLUM	SUKHA RANJAN SAHA	SUBAL SAHA	RAMKRISHNA ROAD.	GENERAL		MALE	907452084273	

Sub-Assistant Engineer
HABRA MUNICIPALITY